

Fiat 500X Crossover (334) 02/2015 >>
Jeep Renegade (BU) 10/2014 >>
Jeep Renegade Hybrid 08/2020 >>
Jeep Compass (MP) 07/2017 >>
Jeep Compass Hybrid 08/2020 >>

Partnr.: FI-044-DX

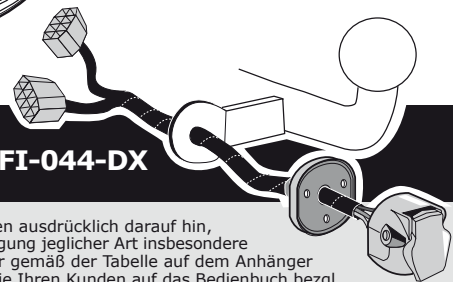

- DE** • Einbauanleitung Elektrosatz Anhängervorrichtung mit 13-P Steckdose lt. DIN/ISO Norm 11446. • Wir weisen ausdrücklich darauf hin, dass eine unsachgemäße und nicht in einer Fachwerkstatt durchgeführte Montage einen Verzicht auf Entschädigung jeglicher Art insbesondere bezüglich des Produkthaftpflichtrechts zur Folge hat. • Technische Änderungen vorbehalten. • Widerstand nur gemäß der Tabelle auf dem Anhänger verwenden. • Achtung! Bitte lesen Sie vorab diese Anleitung, nehmen Sie diese zur Kenntnis und verweisen Sie Ihren Kunden auf das Bedienbuch bezgl. der eventuell zu treffenden Maßnahmen zum ziehen eines Anhängers. • Bei Funktionsproblemen ist die Fehlersuche auf ca. 0,5 Stunden zu begrenzen, kontaktieren Sie die ECS Technical Support: ts@ecs-electronics.nl / 00800 22552327
- FR** • Instructions de montage du faisceau électrique pour crochet d'attelage conforme à la norme DIN/ISO 11446 prise 13-P. • Il est expressément prévu qu' on ne saurait se prévaloir d'un quelconque préjudice contractuel ou réhibitoire si le montage avait été fait en dépit des dites instructions ou dans un garage ne disposant pas des équipements adéquats. • Sous réserve de modifications techniques. • Ne excédez pas la charge maximale, indiquée dans le tableau. • Attention! Avant de commencer le branchement, on vous prie de prendre compte des connections à faire dans la notice, ainsi que communiquer directement à votre client les mesures à prendre pour tirer une remorque. • S'il y a des problèmes de fonctionnement, limiter la recherche de défauts à env. 30 minutes et contacter ECS l'Aide en ligne: ts@ecs-electronics.nl / 00800 22 55 23 27.
- NL** • Montage-handleiding elektrokabelset voor trekhaak met 13-P contactdoos vlg. DIN/ISO norm 11446. • Wij wijzen er met nadruk op, dat ondeskundige en niet door een vakkundige werkplaats uitgevoerde montage tot gevolg heeft dat daardoor ieder recht op schadevergoeding, ook op wettelijke aansprakelijkheid inzake producten, vervalt. • Technische wijzigingen voorbehouden. • Gebruik alleen belasting volgens aansluittabel op het getrokken voertuig. • Opgelet! Wij verzoeken U dringend vooraf deze instructie door te nemen, hiervan kennis te nemen en uw cliënt te verwijzen naar het instructieboekje betreffende de eventueel te nemen maatregelen voor het trekken van een aanhangwagen. • Bij werkingsproblemen moet de foutencontrole tot ca. 0,5 uur beperkt worden, neem contact op met de ECS Technical Support: ts@ecs-electronics.nl / 00800 22 55 23 27.
- GB** • Fitting instructions electric wiring kit tow bar with 13-P socket up to DIN/ISO Norm 11446. • We would expressly point out that assembly not carried out properly by a competent installer will result in cancellation of any right to damage compensation, in particular those arising by virtue of the product liability act. • Contents of these kits and their fitting manuals are subject to alteration without notice, please ensure that these instructions are read and fully understood before commencing installation. • Do not overload circuits; the maximum loads per connection are detailed in this manual. • Attention! Before Installation, please read this manual carefully and inform your customer to consult the vehicle owners manual to check for any vehicle modifications required before towing. • In the event of functional problems, troubleshooting must be limited to about 0.5 hours, contact the ECS Technical Support: ts@ecs-electronics.nl / 00800 22 55 23 27.
- ES** • Instrucciones de montaje de kit eléctrico para enganche de remolque con caja de conexiones 13-P según norma DIN/ISO 11446. • El montaje inapropiado y efectuado por personal no cualificado originará la pérdida de todo derecho a indemnización o la expiración de toda responsabilidad civil con respecto al producto. • Nos reservamos el derecho a efectuar modificaciones técnicas. • Utilice sólo cargas de acuerdo a la tabla de conexión del vehículo remolcado. • Atención: lea atentamente este manual antes de la instalación e informe al cliente que debe consultar el manual de usuario del vehículo para conocer cualquier modificación realizada. • En caso de tener problemas con su funcionamiento, la búsqueda de errores está limitada a aprox. 0,5 horas, por lo que le recomendamos ponerse en contacto con el servicio de atención telefónica: ts@ecs-electronics.nl / 00800 22 55 23 27.
- IT** • Istruzioni di montaggio di set di cavi elettrici per gancio da traino con zoccolo a 13-P conforme alla norma DIN/ISO 11446. • Sottolineiamo espressamente che un montaggio inadeguato ed eseguito da un'officina non specializzata ha come conseguenza il decadere di qualsiasi diritto al risarcimento danni, nonché alla responsabilità legale relativa ai prodotti. • Ci si riserva il diritto di apportare modifiche tecniche. • Utilizzare esclusivamente un carico conforme alla tabella degli allacci relativa al veicolo in questione. • Attenzione! Vi invitiamo a leggere attentamente questo manuale e a invitare a vostra volta i clienti a leggere il manuale del conducente sulle eventuali misure da prendere per l'attacco di un rimorchio. • In caso di problemi di funzionamento, la ricerca di errori dovrebbe essere limitata a circa 0,5 ore. Contattare il centralino di assistenza per i fasci di cavi: ts@ecs-electronics.nl / 00800 22 55 23 27.
- SE** • Monteringsanvisningar elkabelsats för dragkrok med 13-P kontaktdosa enligt DIN/ISO norm 11446. • Vi påpekar med eftertryck att all rätt till skadeersättning och all laglig ansvarighet förfaller om monteringen inte har utförts på rätt sätt och av en professionell verkstad. • Tekniska ändringar förbehålles. • Använd endast belastning enligt anslutningstabellen på det dragna fordonet. • Varning! Innan installation, läs den här handboken noga och informera din kund om att läsa fordonets användarhandbok för att undersöka vilka eventuella ändringar som behöver göras på fordonet. • Vid funtionsproblem ska felsökningen begränsas till ca 0,5 timme, kontakta reservdels-helpline ts@ecs-electronics.nl / 00800 22 55 23 27.
- CZ** • Montážní pokyny: souprava pro elektrické propojení tažné tyče s 13-P zásuvkou do normy DIN/ISO 11446. • Výslovně zdůrazňujeme, že jakákoli montáž, která není provedená ve specializované dílně, má za následek odvolání nároků na kompenzaci jakéhokoli druhu, obzvláště vyplývajících ze zákona o odpovědnosti za způsobené škody. • Změny mohou být provedeny bez oznámení. • Používejte pouze při maximálním nabití podle tabulky na tažném vozidle. • Upozornění! Prosíme, abyste si nejdříve přečetli tyto instrukce, seznámili se s nimi a odkázali své zákazníky na příručku týkající se případných opatření, která musí být přijata pro tažení přívěsu. • Při problémech funkčnosti je třeba vyhledávání chyb omezit na cca 0,5 hodiny, kontaktujte ECS Technical Support: ts@ecs-electronics.nl / 00800 22 55 23 27.
- DK** • Monteringsvejledninger for det elektriske ledningsføringssæt for trækstang med 13-P stikdåse, DIN/ISO, norm 11446. • Vi ønsker at gøre udtrykkeligt opmærksom på atforkert samling, der ikke er udført af et specialiseret værksted, resulterer i bortfaldelse af kompensationskrav af alle slags, i særdeles krav der måtte opstå omkring det lovligtige ansvar. • Kan ændres uden varsel. • Brug kun den maksimale belastning, i overensstemmelse med forbindelsestabelen for bugserede køretøjer. • OBS! For installation skal denne vejledning læses omhyggeligt og din kunde skal informeres om at kigge i køretøjets håndbog for at kontrollere om der skal laves eventuelle ændringer på køretøjet inden bugsering. • Ved funktionsproblemer skal fejlsøgningen begrænses til ca. 0,5 time, kontakt ECS Technical Support: ts@ecs-electronics.nl / 00800 22 55 23 27.
- FI** • Ohjeet vetokoukun sähkökaapelisarjan asentamiseen, jossa on DIN/ISO 11446 mukainen 13-P liitin. • Korostamme, että kaikki oikeudet vahinkokorvaukseen kuten myös valmistajan laillinen vastuu raukeavat, mikäli asennusta ei ole toteutettu oikealla tavalla eikä ammattitaitoisen asiantuntijan toimesta. • Oikeus teknisiin muutoksiin ilman erillistä huomautusta pidätetään. • Huomio! Lue tämä käyttöopas huolellisesti ennen asennusta ja tiedota asiakkaita tarkistamaan kaikki ajoneuvon muutoksen ajoneuvon omistajan käyttöoppaas ennen hinausta. • Kuormita työvirtapiiriä ainoastaan hinattavan ajoneuvon kytkentäkaavin mukaisesti. • Virhehaku on rajoitettava toiminto-ongelmien esiintyessä noin 0,5 tuntiin, ota yhteys ECS Technical Support: ts@ecs-electronics.nl / 00800 22 55 23 27.
- GR** • Οδηγίες συναρμολόγησης ηλεκτρικού σετ καλωδίων μπάρας ρυμούλκησης με υποδοχή 13-P μέχρι DIN/ISO Κανόνας 11446. • Επισημαίνουμε κατηγορηματικά ότι οποιαδήποτε εφαρμμένη συναρμολόγηση, η οποία δεν έχει πραγματοποιηθεί ειδικό εργαστήριο θα οδηγήσει σε αποποίηση των αξιώσεων επιβολής αποζημιώσεων οποιοδήποτε είδους, ειδικά όσα προκύπτουν από το νόμο ευθύνης προϊόντων. • Μπορεί να τροποποιηθεί χωρίς προηγούμενη ειδοποίηση. • Χρησιμοποιείτε μόνο μέγιστο ηλεκτρικό φορτίο σύμφωνα με τον πίνακα σύνδεσης στο ρυμούλκούμενο όχημα. • Προσοχή! Πριν την εγκατάσταση, διαβάστε το χειρίδιο αυτό προσεκτικά και ενημερώστε τον πελάτη σας να συμβουλευτεί το χειρίδιο ιδιοκτητήτων οχήματος ώστε να ελέγξει τυχόν τροποποιήσεις που απαιτούνται στο όχημα πριν τη ρυμούλκηση. • Σε περίπτωση προβλημάτων λειτουργίας να περιοριστεί η αναζήτηση σφαλμάτων σε περί. 0,5 δευτ., επικοινωνήστε με τη γραμμή υποστήριξης ECS Technical Support: ts@ecs-electronics.nl / 00800 22 55 23 27.
- NO** • Monteringsanviser elkabelsett for trekkrok med 13-P koblingsboks ifølge DIN/ISO norm 11446. • Vi påpeker ettertrykkelig at all rett til skadeerstatning og rettslig ansvar forfaller dersom monteringen ikke er blitt utført på riktig måte og av et profesjonelt verksted. • Tekniske endringer forbeholdes. • Overskrid ikke grensene anviset i tilkoblingstabellen på tilhengeren eller det tilkoblede kjøretøyet. • OBS! Les denne bruksanvisningen nøye før installasjon. Be kunden om å rådføre seg med brukerhåndboken for kjøretøyeiere for å sjekke om kjøretøyet må modifiseres før tauing. • Ved funksjonsproblemer må feilsøket begrenses til ca. 0,5 timer, kontakt ECS Technical Support: ts@ecs-electronics.nl / 00800 22 55 23 27.
- PL** • Instrukcje montażu zestawu okablowania elektrycznego dysza holowniczego z 13-P stykowym gniazdem DIN/ISO 11446. • Chcielibyśmy wyraźnie zaznaczyć, iż wszelki nieprawidłowy montaż, który nie jest wykonywany w specjalistycznym warsztacie posiada z sobą utratę możliwości dochodzenia wszelkiego typu roszczeń, w szczególności tych wynikających z odpowiedzialności producenta za swój produkt. • Podlega zmianom bez powiadomienia. • Używać tylko takiego maksymalnego obciążenia które wynika z tabliczki połączeń holowanego pojazdu. • Uwaga! Przed zainstalowaniem należy dokładnie przeczytać tę instrukcję i poinformować klienta o konieczności sprawdzenia w instrukcji posiadacza pojazdu w celu sprawdzenia przed holowaniem, czy nie wprowadzono do pojazdu jakichkolwiek zmian. • W przypadku problemów ograniczyć wyszukiwanie błędów do ok. 0,5 godziny, skontaktować się z linią serwisową ts@ecs-electronics.nl / 00800 22 55 23 27.

Einzelteilliste

Liste de pièces

Onderdelenlijst

Part list

Lista de componentes

Elenco componenti

Dellista

Seznam dílů

Del-liste

Osaluettelo

Κατάλογος εξαρτημάτων

Delliste

Lista części

DE

FR

NL

GB

ES

IT

SE

CZ

DK

FI

GR

NO

PL

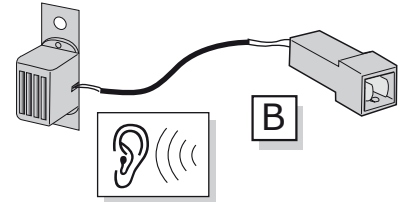
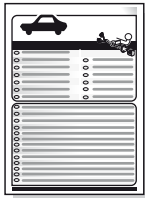
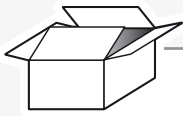

R

G

P

* OPTION +30/+15

4x

L1

L2

L3

L4

X

M

B

* OPTION SP-133-ZZ

vorbereitung für
préparation pour
voorbereiding voor
preparación para
preparazione per
förberedelse för
příprava pro
förberedelse for
valmistelu varten
Προετοιμασία για
förberedelse på
przygotowanie do

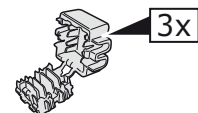
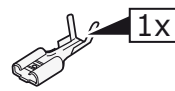
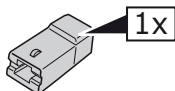
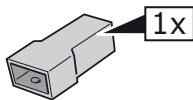
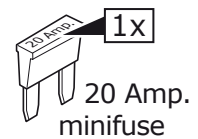
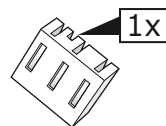
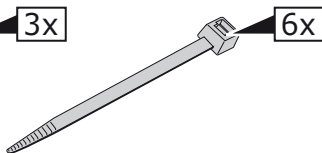
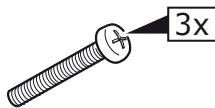
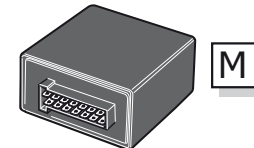
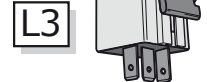
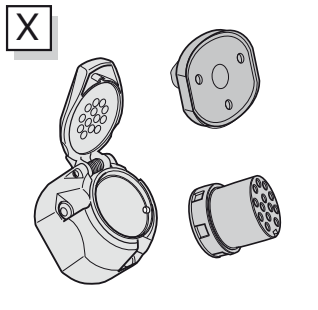
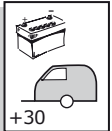
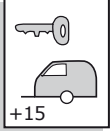

INFO

	BK	BN	BU	GY	GN	WH	YE	OG	PE	PI	RD
(DE)	Schwarz	Braun	Blau	Grau	Grün	Weiß	Gelb	Orange	Violett	Rosa	Rot
(FR)	Noir	Marron	Bleu	Gris	Vert	Blanc	Jaune	Orange	Violet	PI	Rouge
(NL)	Zwart	Bruin	Blauw	Grijs	Groen	Wit	Geel	Oranje	Paars	Roze	Rood
(GB)	Black	Brown	Blue	Grey	Green	White	Yellow	Orange	Purple	Pink	Red
(ES)	Negro	Marrón	Azul	Gris	Verde	Blanco	Amarillo	Naranja	Morado	Rosa	Rojo
(IT)	Nero	Marrone	Blui	Grigio	Verde	Bianco	Giallo	Arancione	Viola	Rosa	Rosso

1

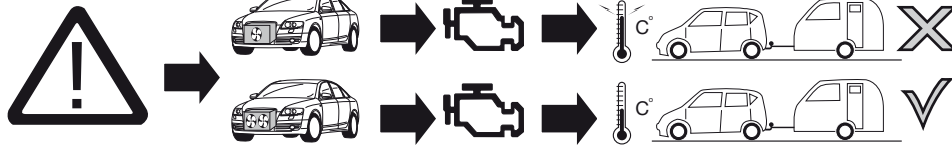

ACHTUNG!

(DE)

Die Kühlerleistung des Fahrzeuges muß bei Nachrüstung einer Anhängerkupplung möglicherweise erhöht werden! Bitte unbedingt Herstellerangaben beachten!!

ATTENTION!

(FR)

Il peut s'avérer nécessaire d'augmenter la puissance du radiateur du véhicule lorsque celui est équipé ultérieurement d'un attelage remorque! Respecter impérativement les instructions du constructeur!!

ATTENTIE!

(NL)

Het koelvermogen van het voertuig moet mogelijk worden verhoogd als achteraf een aanhangerkoppeling wordt aangebracht! Absoluut de fabrieksofgaven in acht nemen a.u.b.!!

ATTENTION!

(GB)

The vehicle's cooling capacity may have to be increased when retrofitting a trailer coupling! You must observe the manufacturer's instructions!!

¡ATENCIÓN!

(ES)

¡Es posible que haya que aumentar la capacidad del radiador en caso de reequipar un acoplamiento de remolque! ¡Rogamos tener en cuenta las instrucciones de fabricante sin falta!

ATTENZIONE!

(IT)

La capacità di raffreddamento del veicolo, quando si applica un gancio di traino, si deve possibilmente aumentare! Si prega di osservare tassativamente le indicazioni del produttore!!

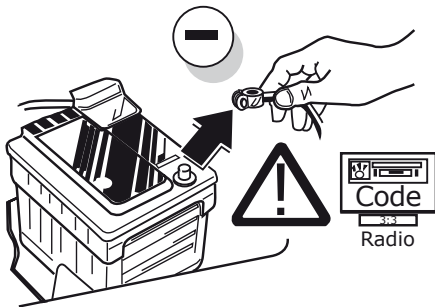

(DE)

Um Störungen und Schäden am Bordnetz zu vermeiden, muss die Massepolklemme unbedingt vor Beginn aller Arbeiten von der Fahrzeugbatterie getrennt werden! Insbesondere bei Arbeiten und Anschlüssen am CAN-Datenbus kann bei nicht abgeklemmter Batterie sowohl das Anhängermodul als auch das fahrzeugseitige Bordnetzsteuergerät beschädigt werden! Bitte Herstellervorschriften beim Ab- und Ankleben der Fahrzeugbatterie beachten!

(FR)

Afin d'éviter tout dys-fonctionnement ou endom-magement du circuit de bord, il est indispensable de débrancher la pince de masse de la batterie du véhicule avant le début de toute opération! En particulier s'il s'agit de travaux et de branchements effectués sur le bus de données CAN, si la batterie n'est pas débranchée, le module remorque aussi bien que le dispositif de commande de circuit de bord du véhicule risquent d'être endommagés! Veuillez respecter les directives du fabricant lors du branchement et du débranchement de la batterie du véhicule!

(NL)

Om storingen en schade aan de elektrische bedrading te vermijden moet de massapoolklem absoluut vóór aanvang van alle werkzaamheden worden losgekoppeld van de voertuigaccu! Vooral bij werkzaamheden aan en aansluitingen op de CAN-databus kan zowel de aanhangermodule als de voertuigzijdige regeleenheid voor de elektrische installatie beschadigd worden, als de accu niet ontkoppeld is! Fabrieksvoorschriften bij het vast- en loskoppelen van de voertuigaccu in acht nemen a.u.b.!

(GB)

In order to avoid mal-functions and damage to the vehicle's electrical system the earth terminal must be disconnected from the vehicle's battery before starting work! Both the trailer module and the vehicle's control unit for the electrical system can be damaged during work on the CAN data bus connections if the battery is not disconnected! Please pay attention to the manufacturer's instructions when disconnecting and reconnecting the vehicle's battery!

(ES)

¡Para evitar fallos y defectos en el sistema eléctrico de a bordo es imprescindible separar al terminal de puesta a tierra de la batería del vehículo antes de realizar cualquier trabajo! ¡Particularmente al realizar trabajos y conexiones al bus de datos CAN puede estropearse tanto el módulo para remolques como el regulador del sistema eléctrico de a bordo del vehículo si no se ha desconectado la batería! ¡Rogamos observar las instrucciones del fabricante al conectar y desconectar la batería del vehículo!

(IT)

Per evitare disturbi e danni alla rete di distribuzione elettrica, l'espansione polare a massa deve essere assolutamente scollegata dalla batteria del veicolo prima dell'inizio dei lavori! In particolare durante i lavori e gli allacciamenti al bus di dati CAN, se la batteria non è scollegata si possono danneggiare sia la centralina rimorchio, sia la centralina della rete di distribuzione elettrica del veicolo! Attenersi alle indicazioni del costruttore per scollegare e ricollegare la batteria del veicolo!

ROUTING

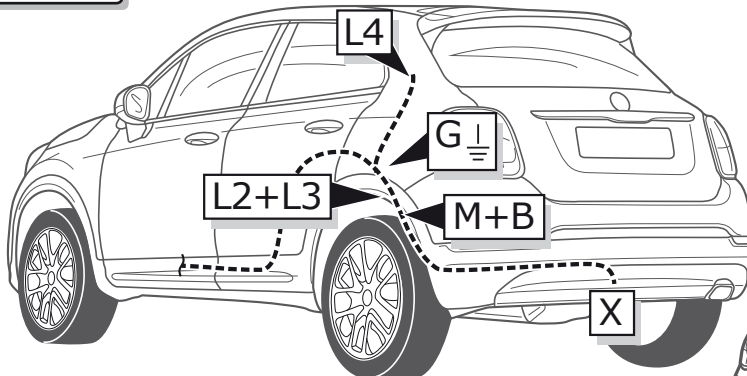

Fiat 500 X

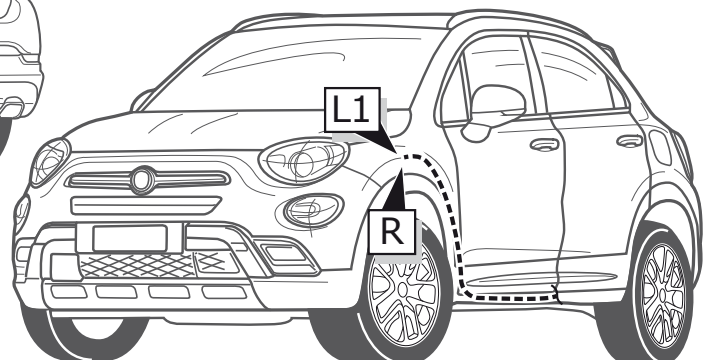

ROUTING

Jeep Renegade

Jeep Renegade Hybrid

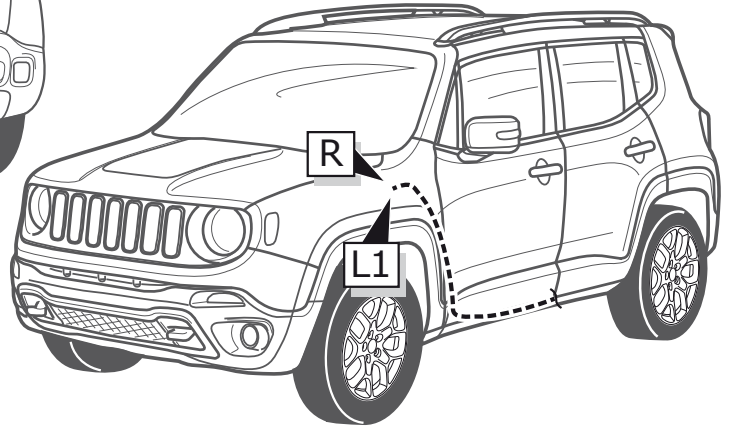
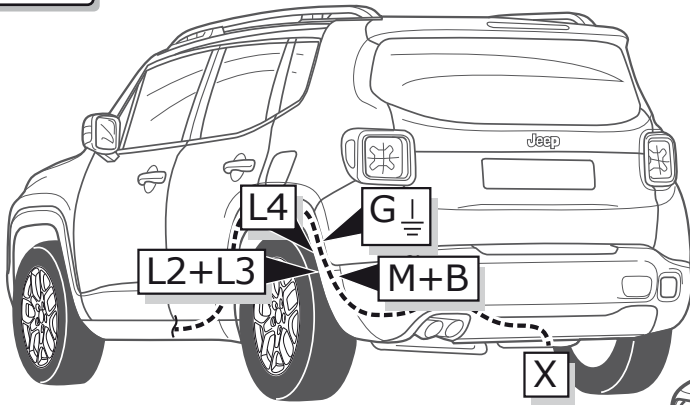

Jeep Compass

Jeep Compass Hybrid

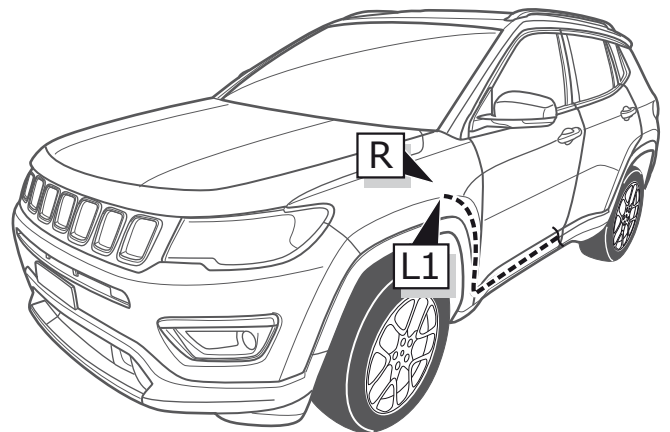
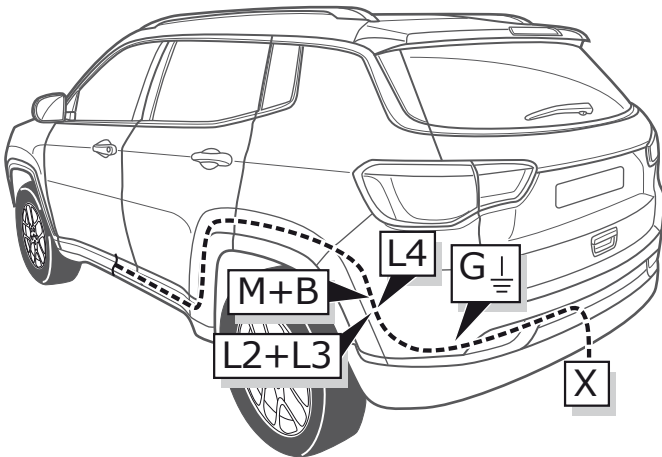

2

Fiat 500 X

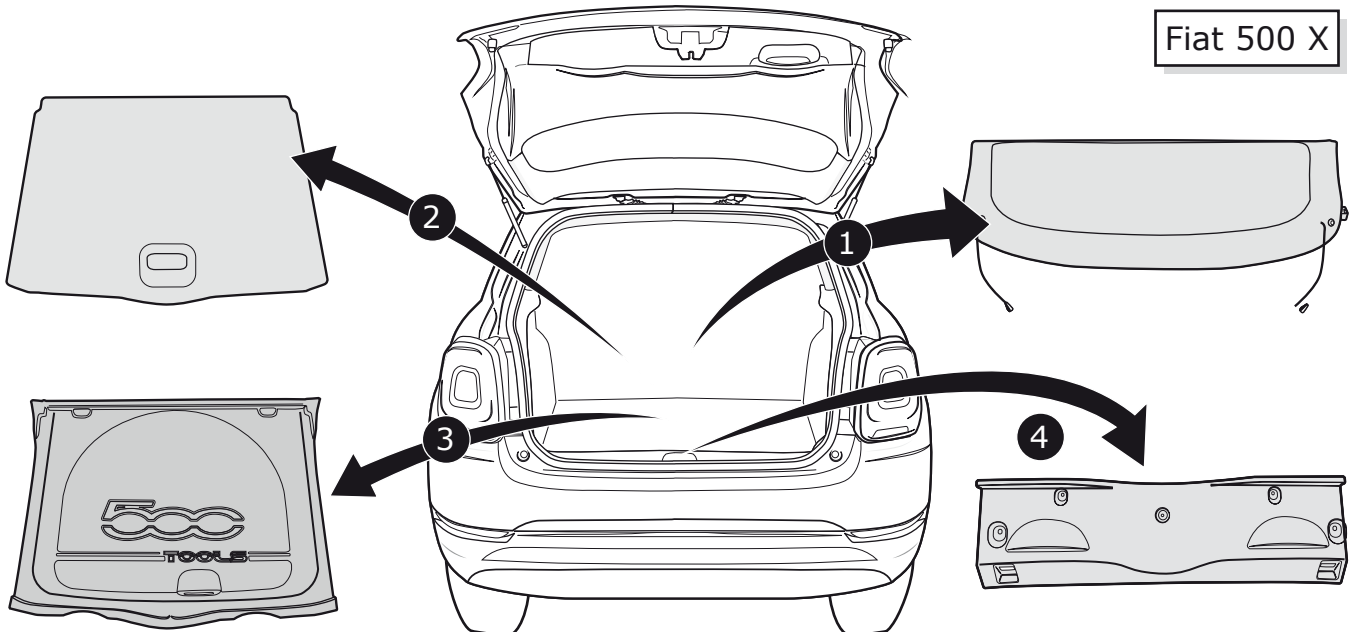

3

Fiat 500 X

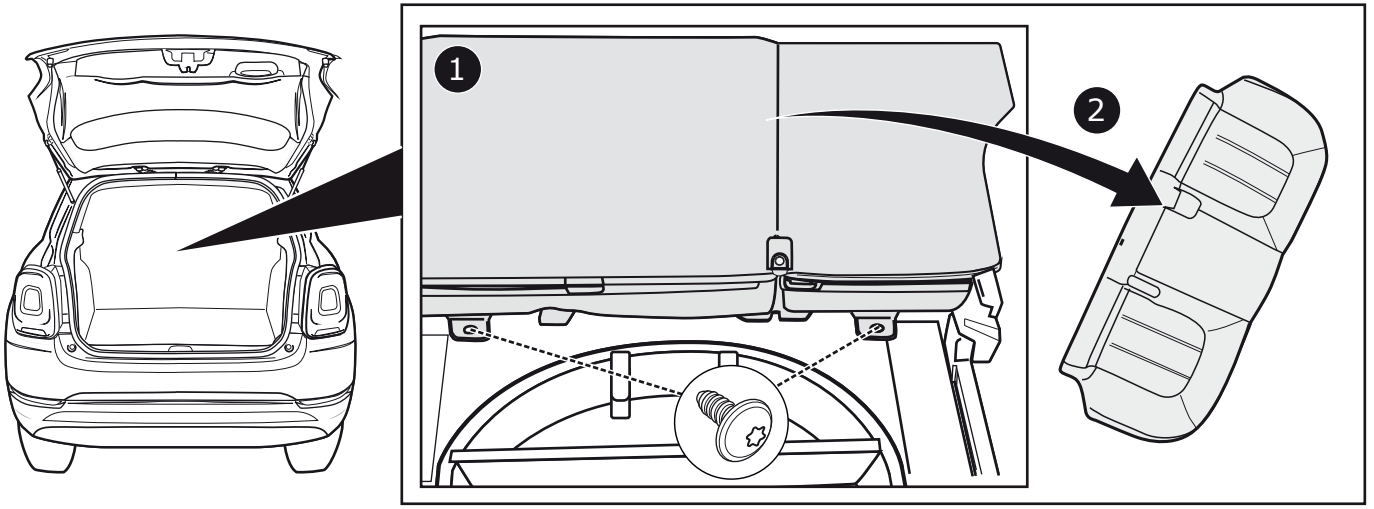

4

Fiat 500 X

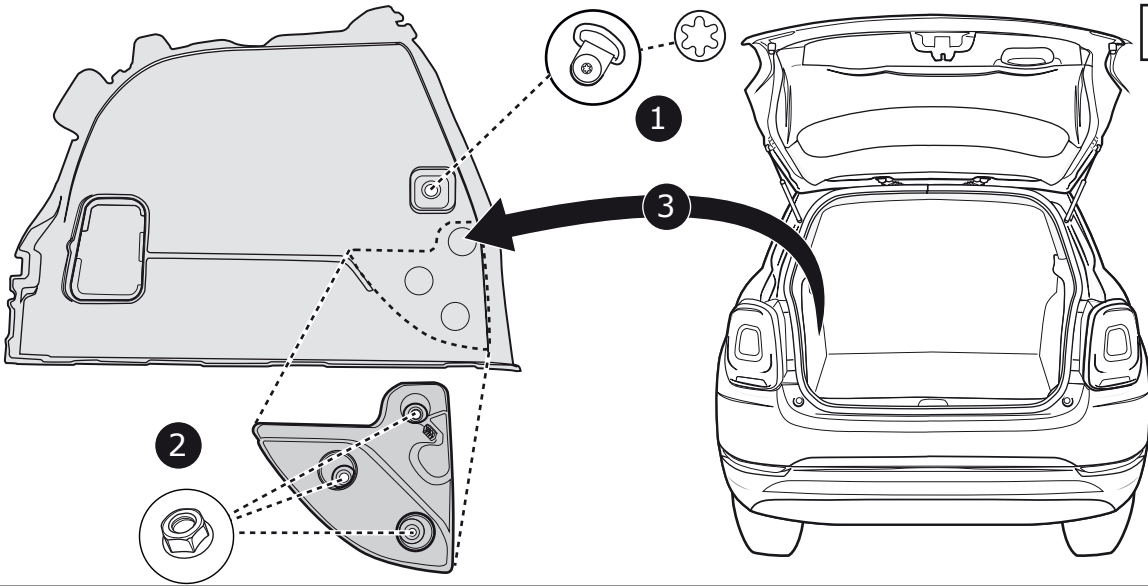

5

Jeep Renegade

Jeep Renegade Hybrid

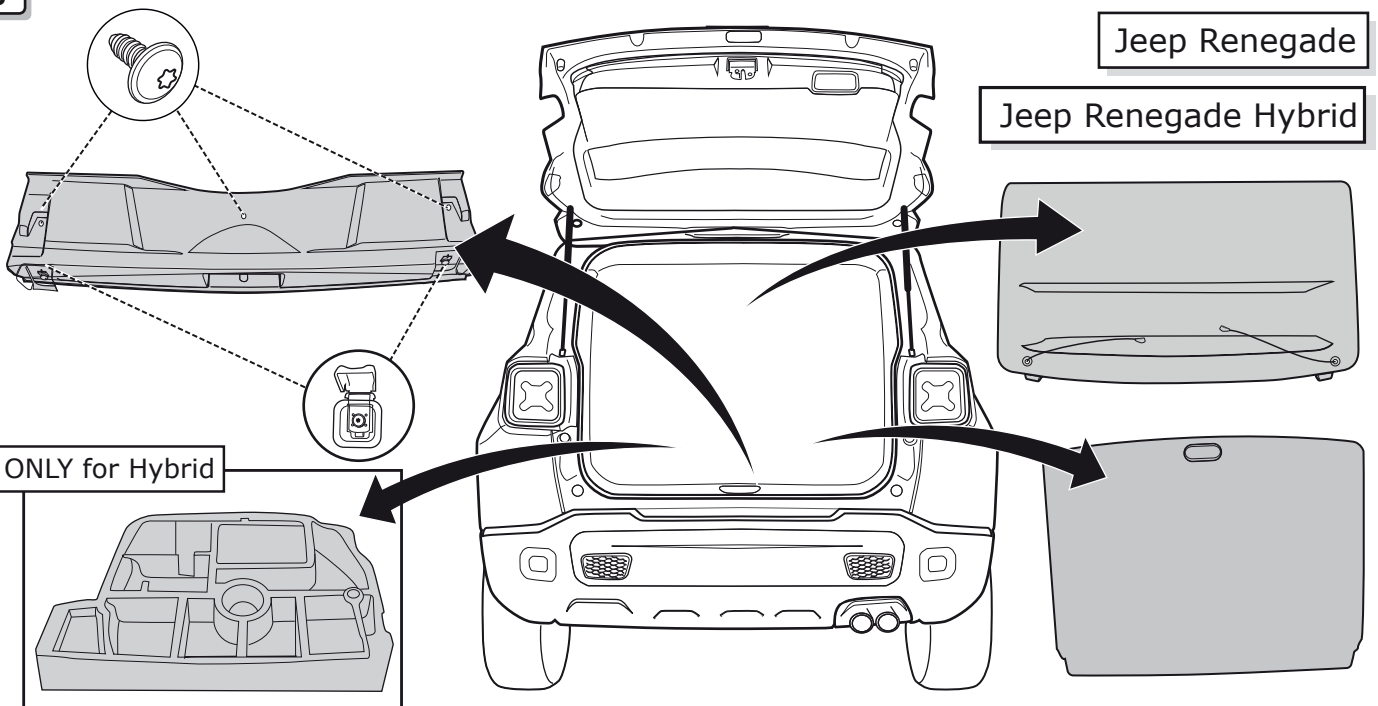

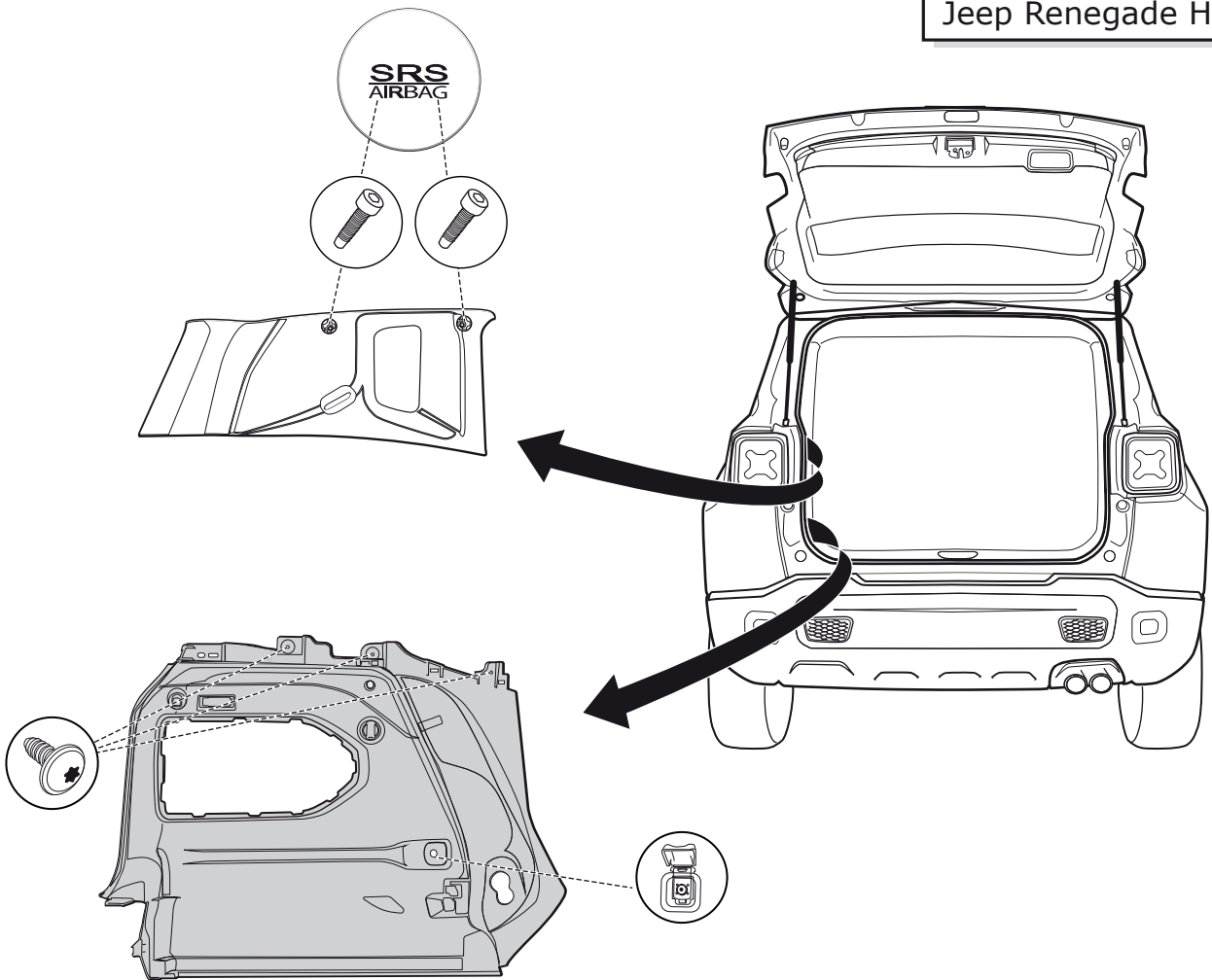
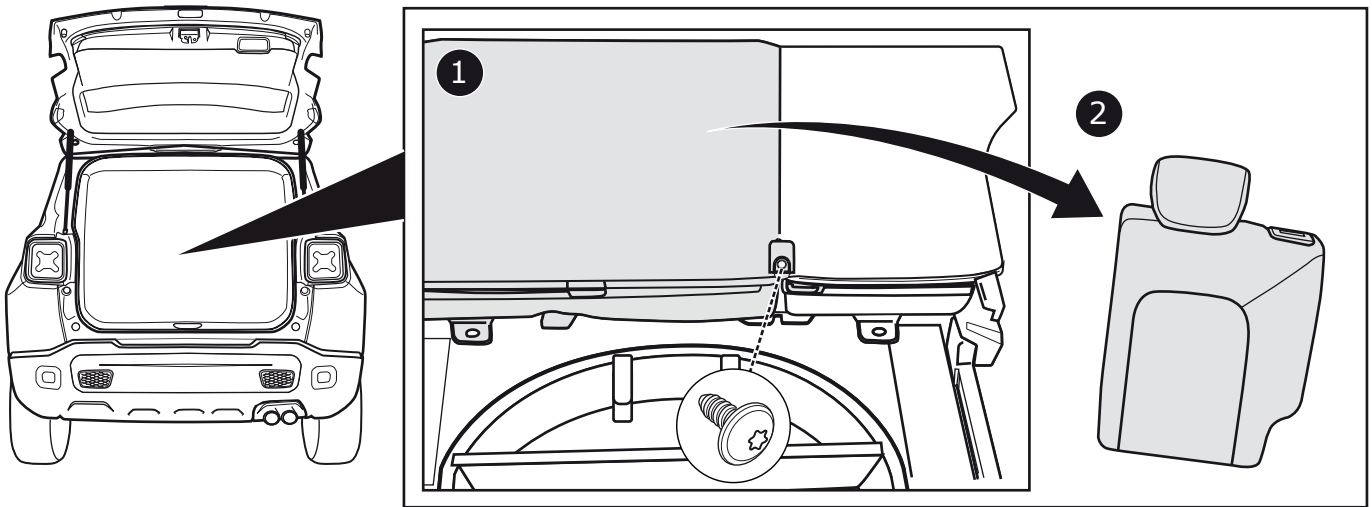

8

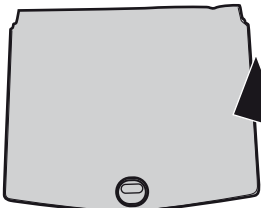
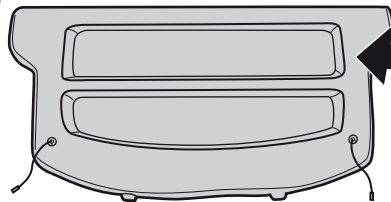

ONLY for Hybrid

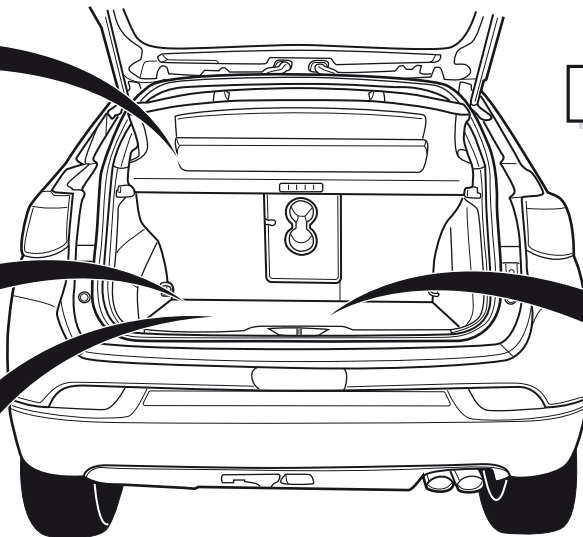
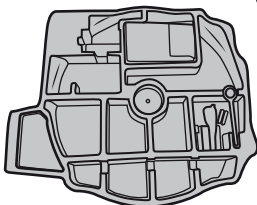

Jeep Compass

Jeep Compass Hybrid

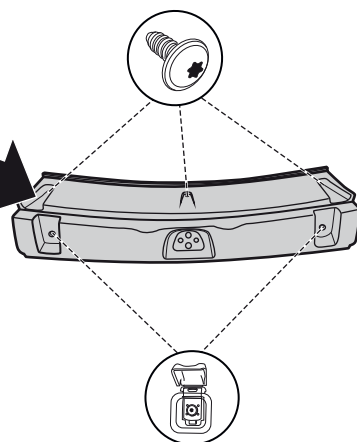

9

Jeep Compass

Jeep Compass Hybrid

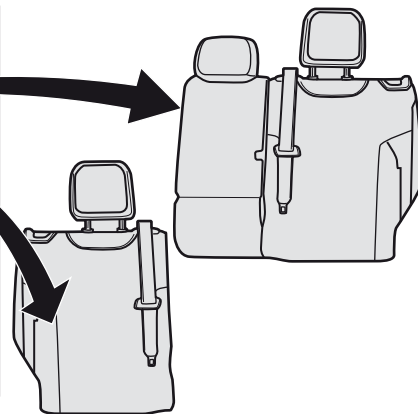
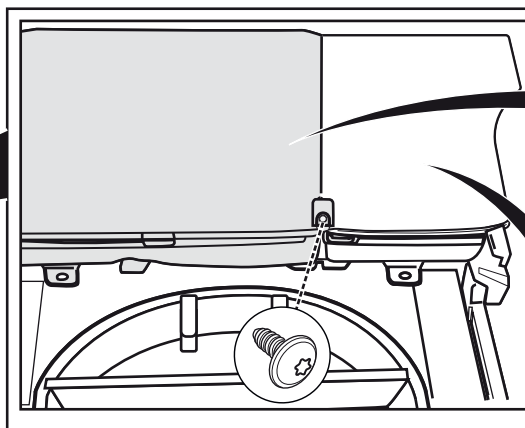
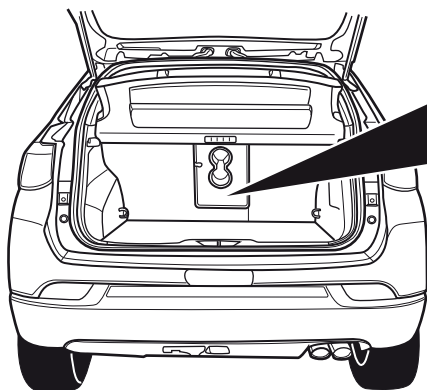

10

Jeep Compass

Jeep Compass Hybrid

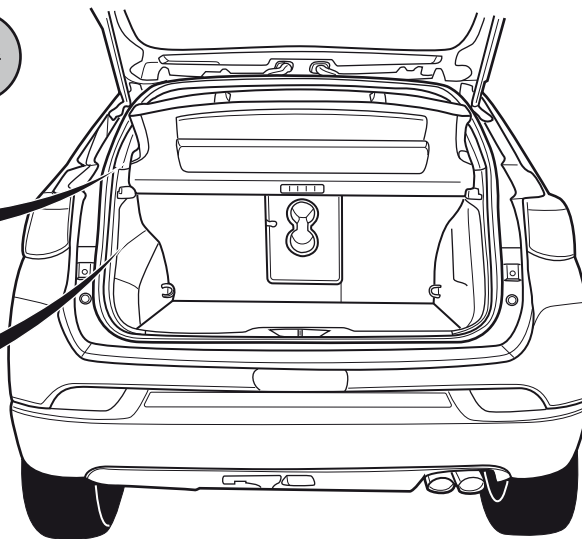
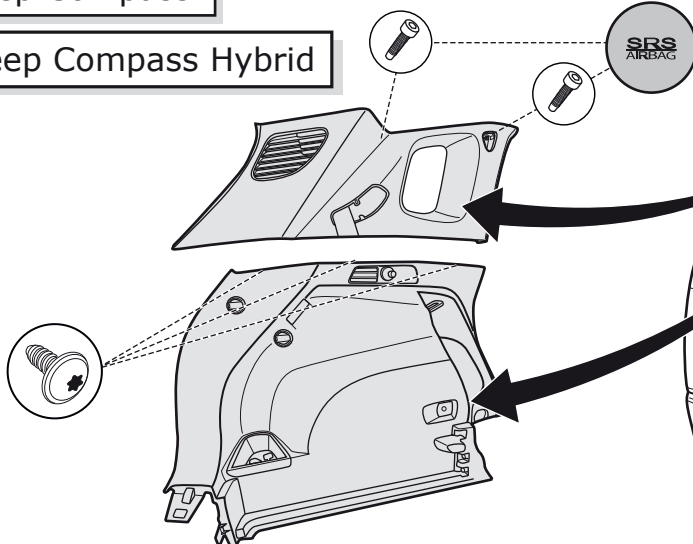

Fiat 500 X

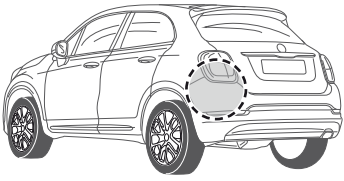

Jeep Renegade

Jeep Renegade Hybrid

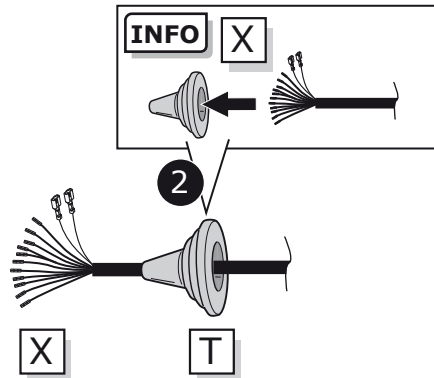
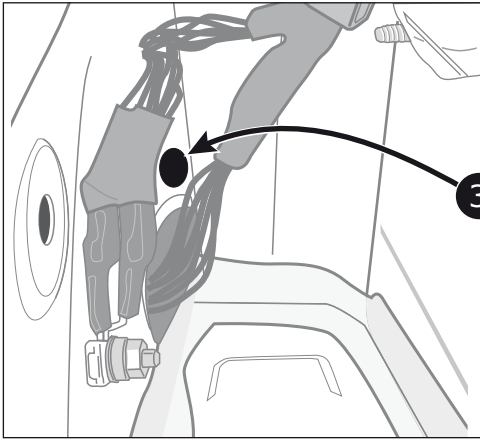
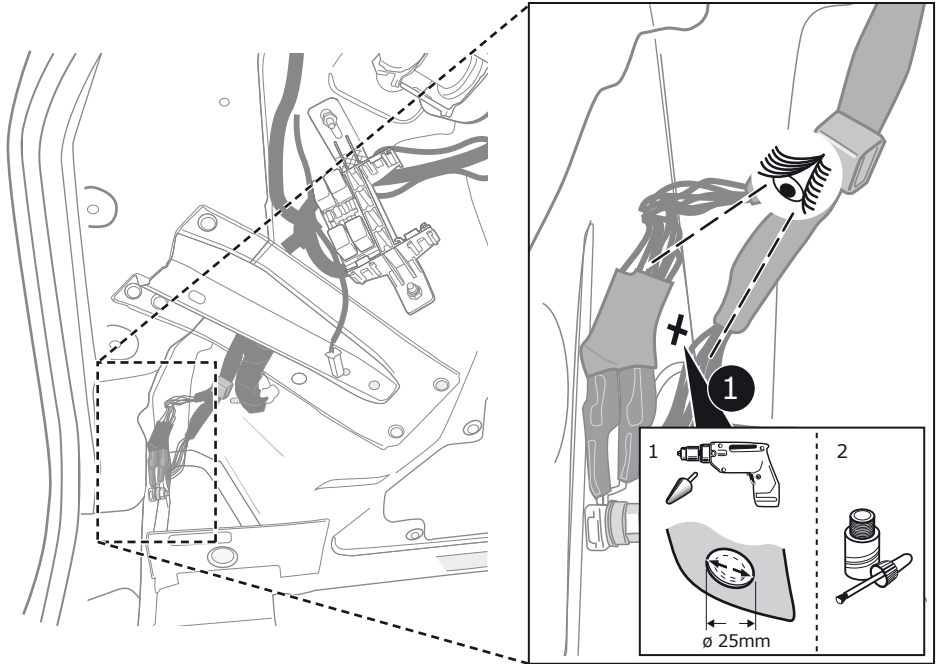
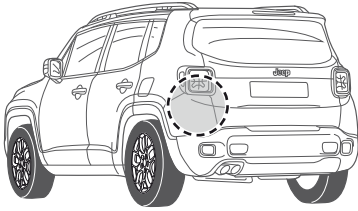

Jeep Compass

Jeep Compass Hybrid

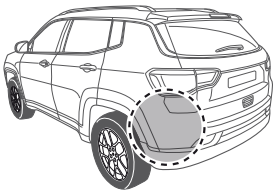

Option 1

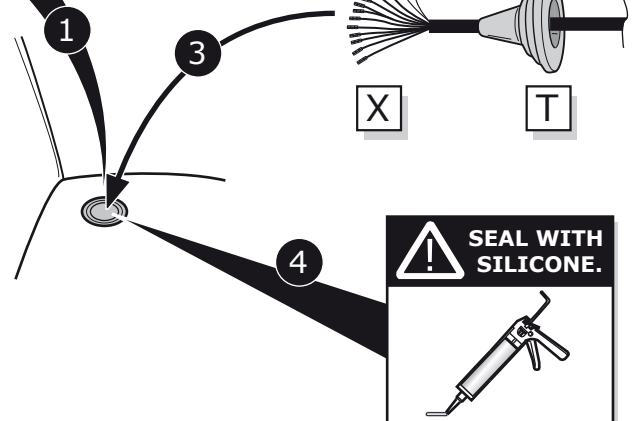
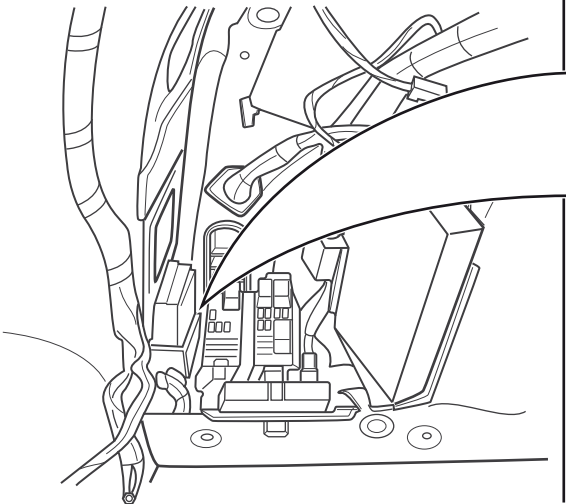
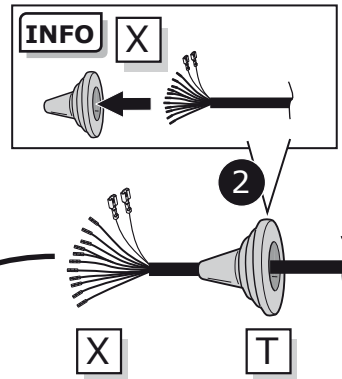

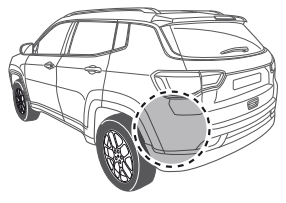

Jeep Compass Jeep Compass Hybrid

Option 2

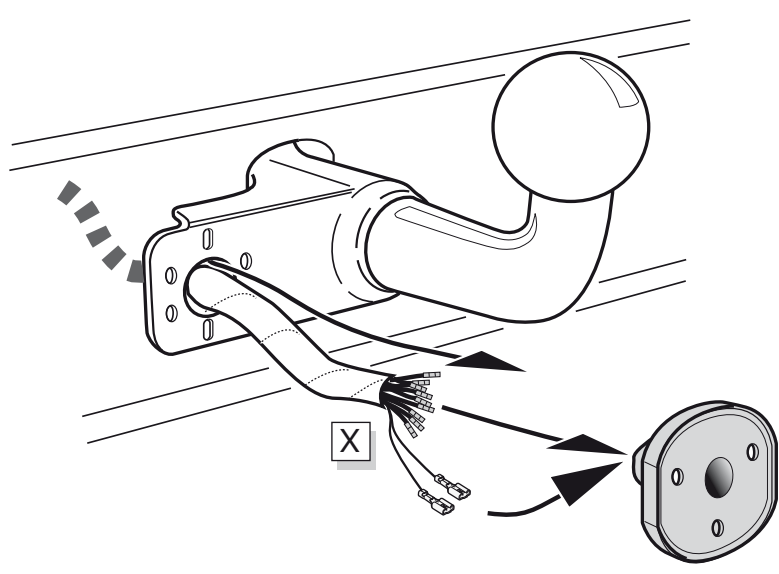
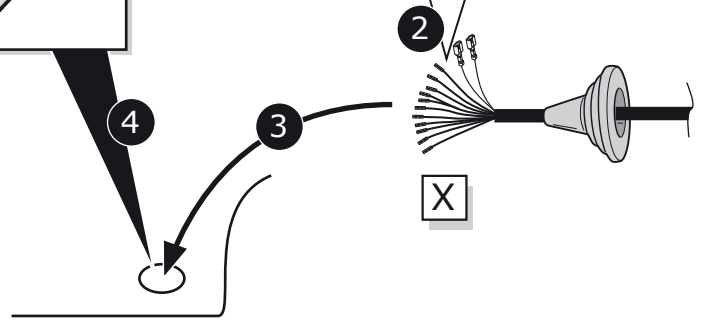
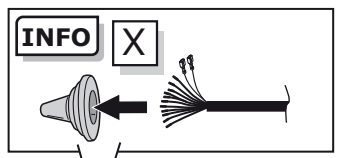
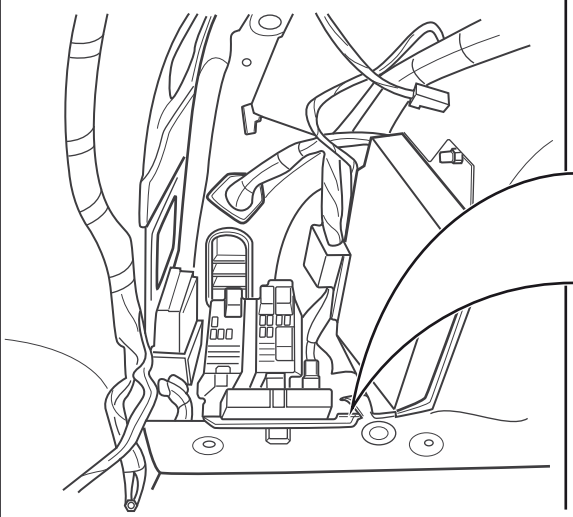
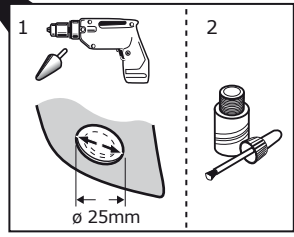
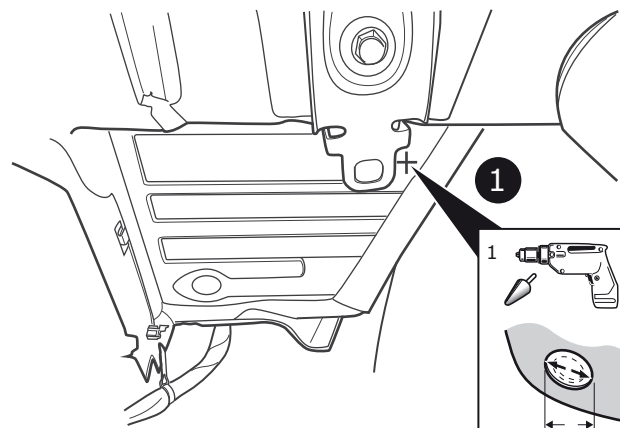
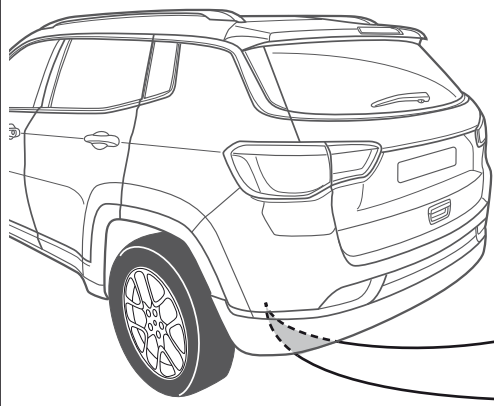

INFO

- (DE) Anschluss Steckdose
- (FR) Connection de la prise
- (NL) Contactdoos aansluiting

- (GB) Socket connection
- (ES) Conexión de la caja de enchufe
- (IT) Allaccio zoccolo



B

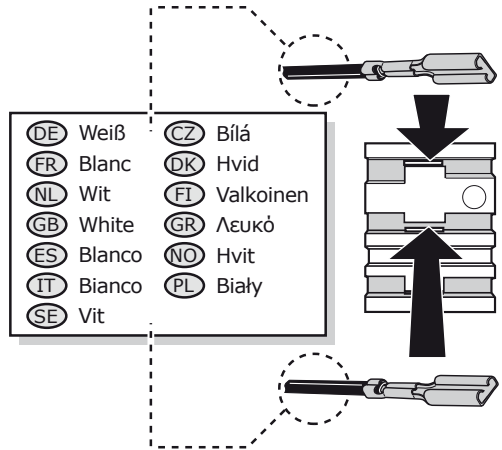
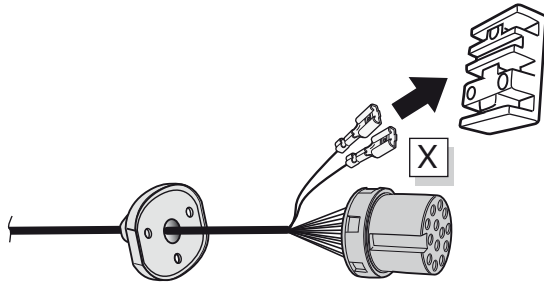

C

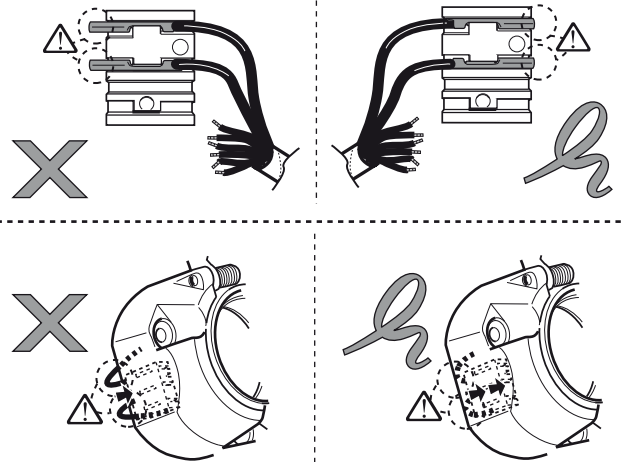
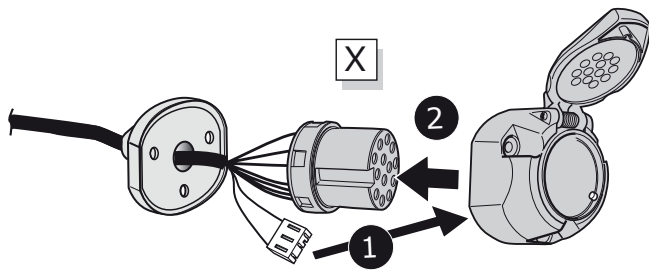

D

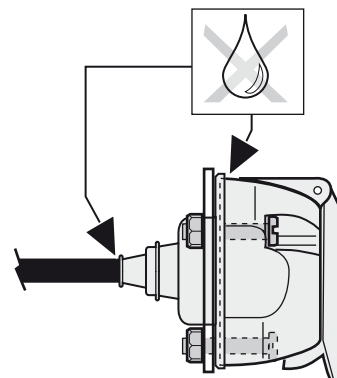
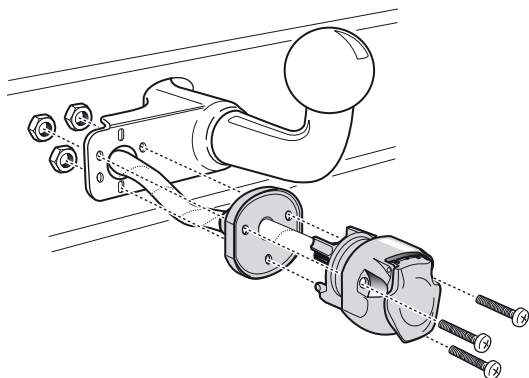

14

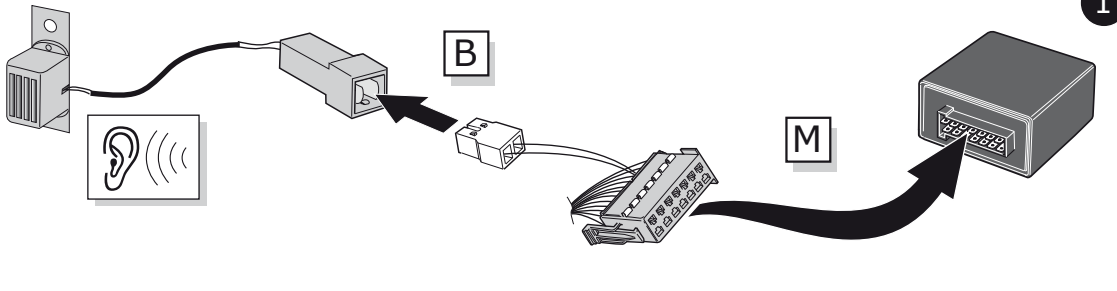

2

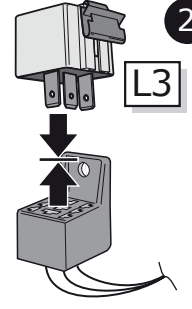

15

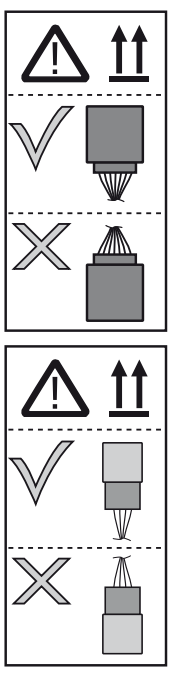
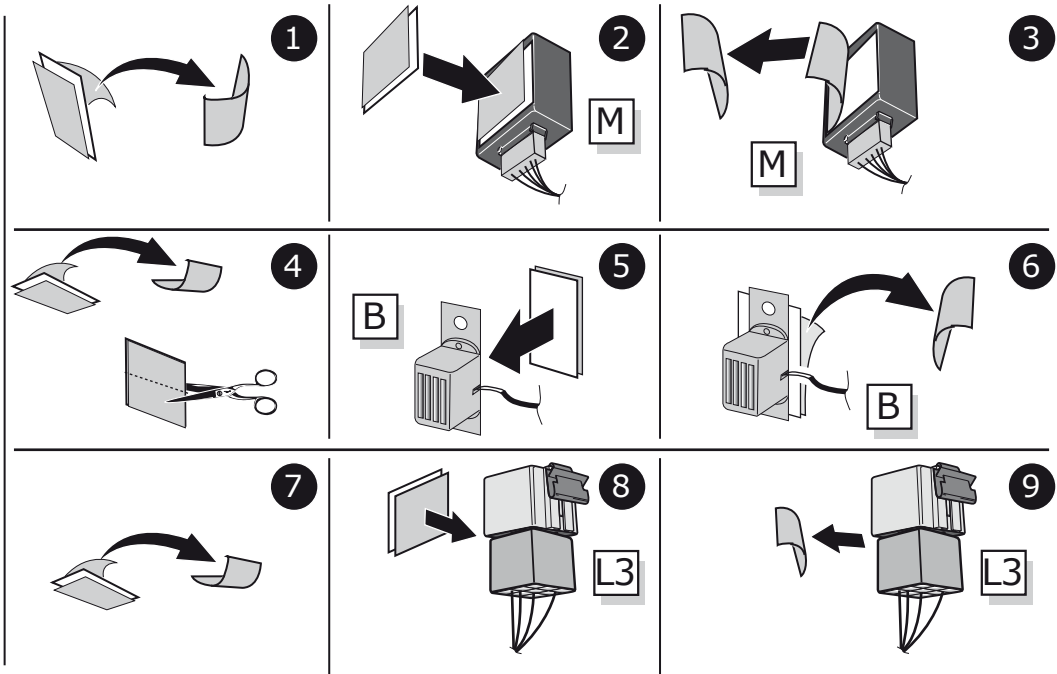

16

Fiat 500 X

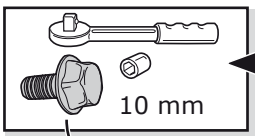
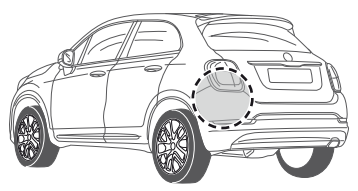

M

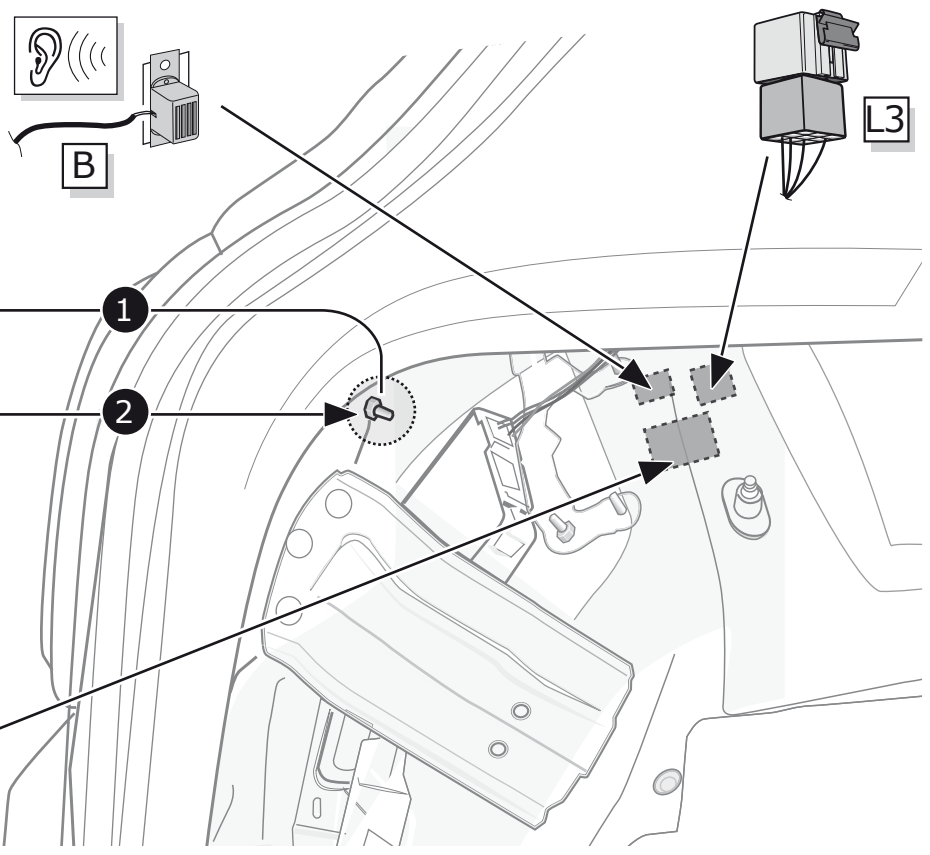

17

Jeep Renegade

Jeep Renegade Hybrid

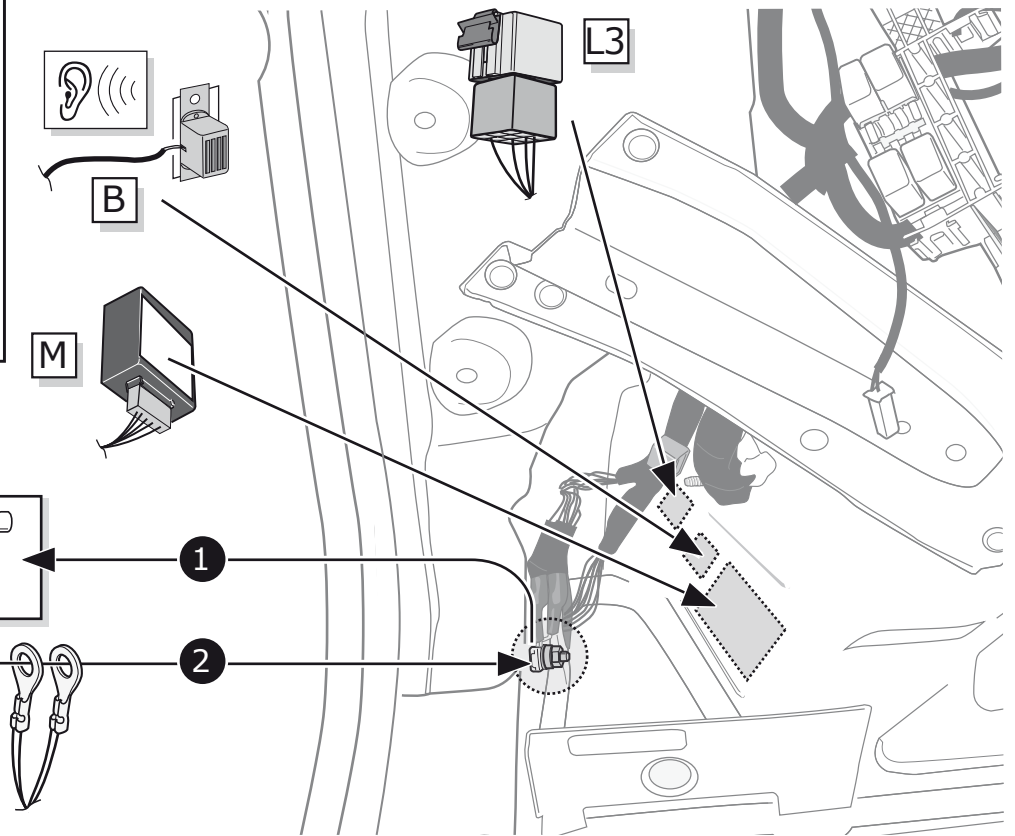
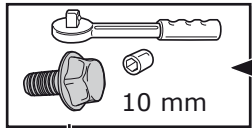
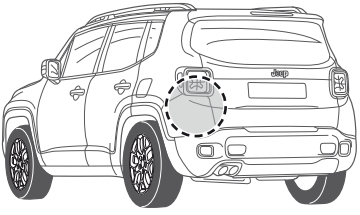

18

Jeep Compass

Jeep Compass Hybrid

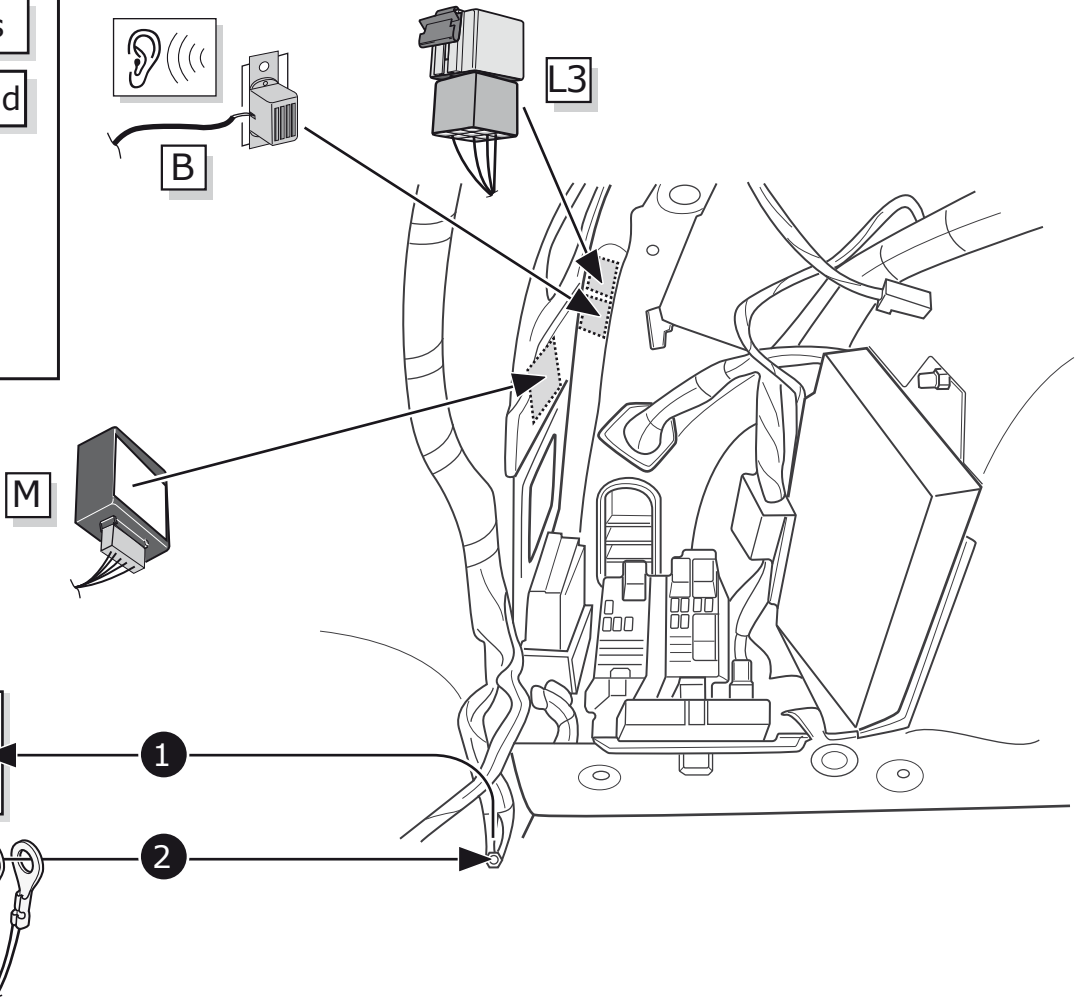
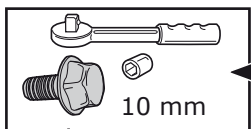
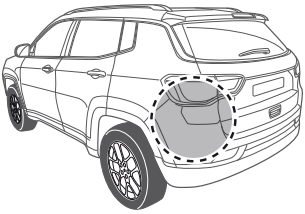

19

Fiat 500 X

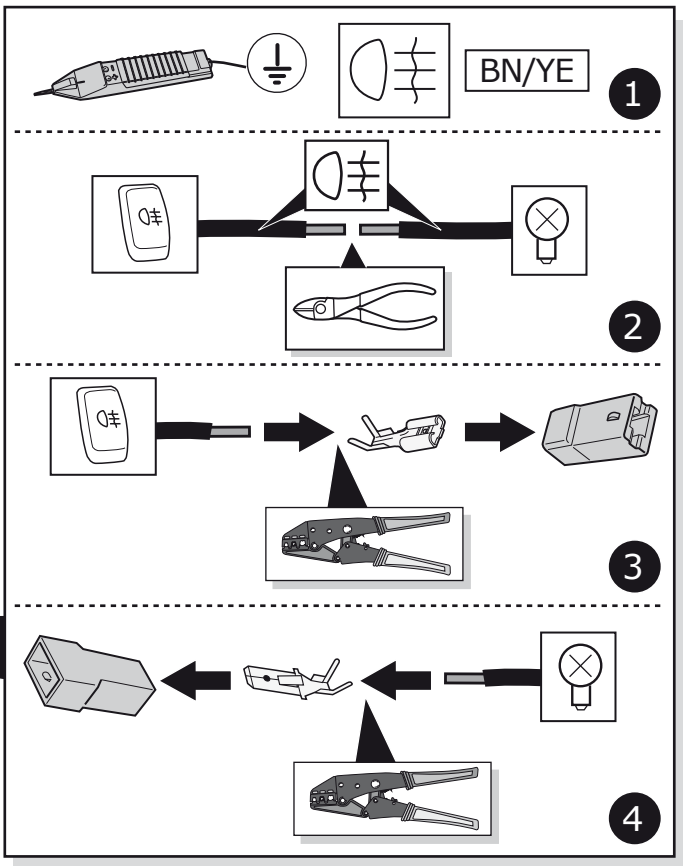
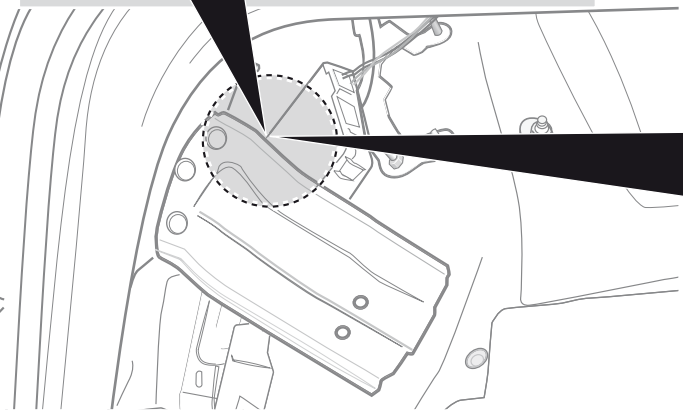
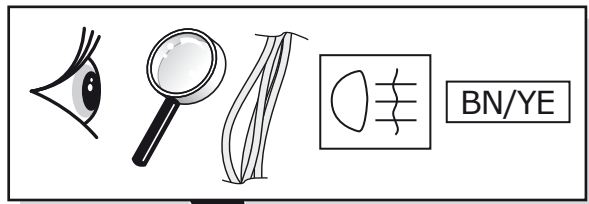
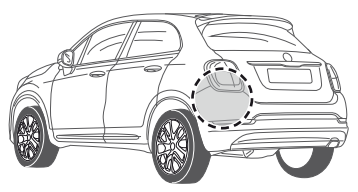

20

Jeep Renegade

Jeep Renegade Hybrid

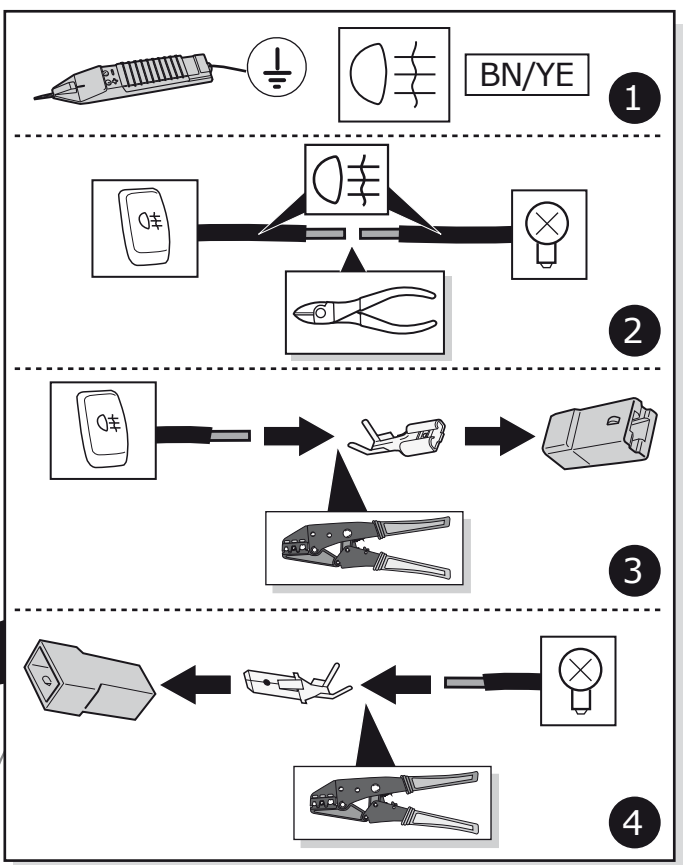
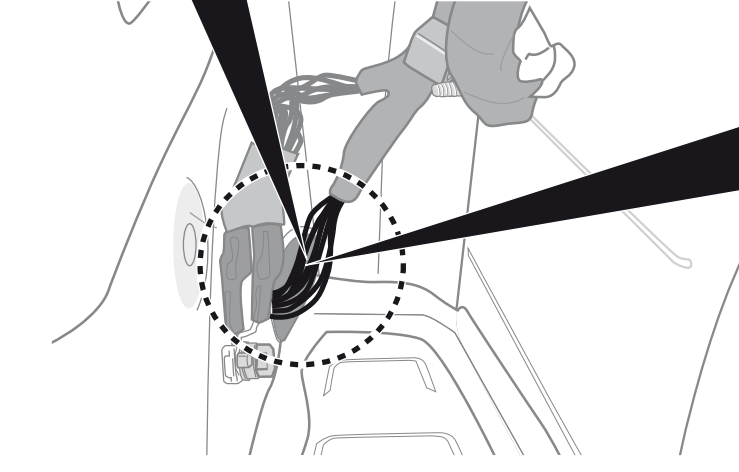
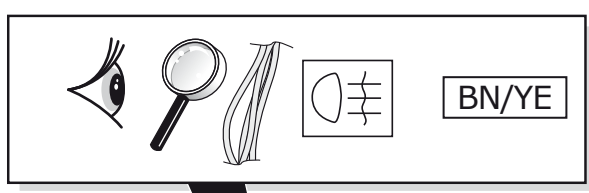
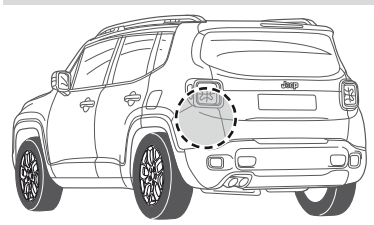

Jeep Compass

Jeep Compass Hybrid

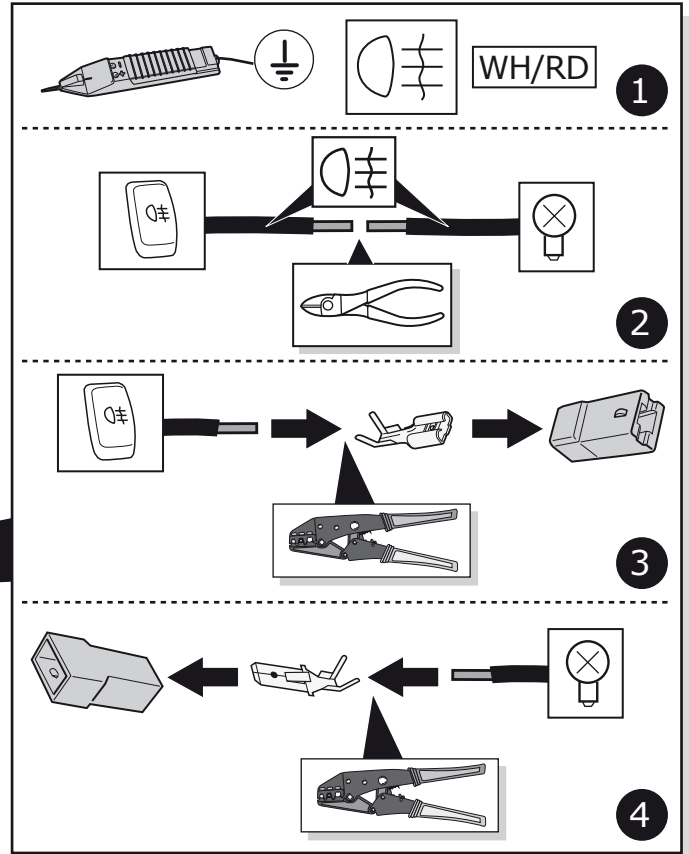
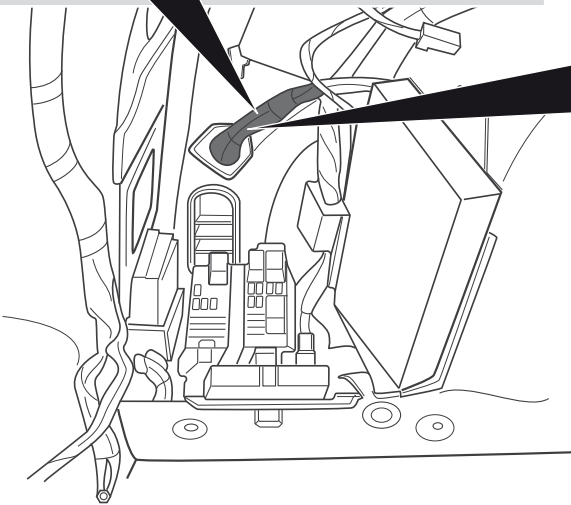
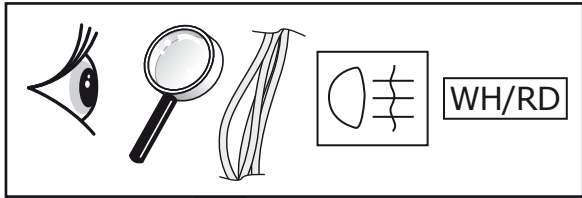
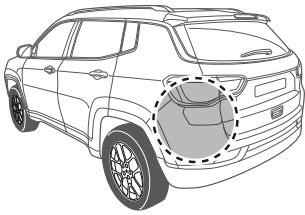

Fiat 500 X



Jeep Renegade

Jeep Renegade Hybrid

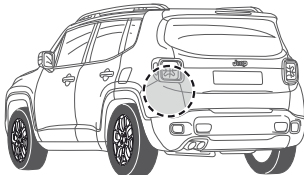

Jeep Compass

Jeep Compass Hybrid

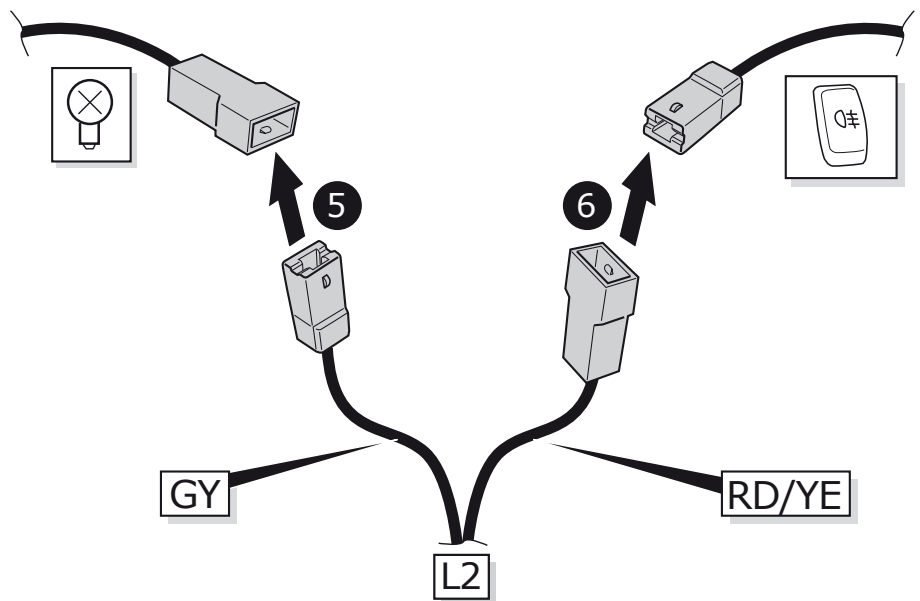
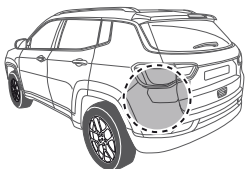

22

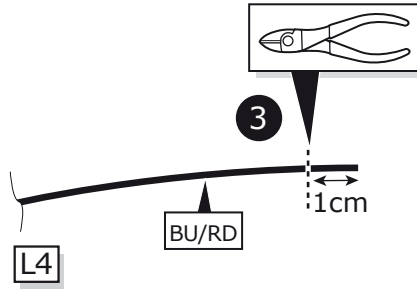

23

Fiat 500 X

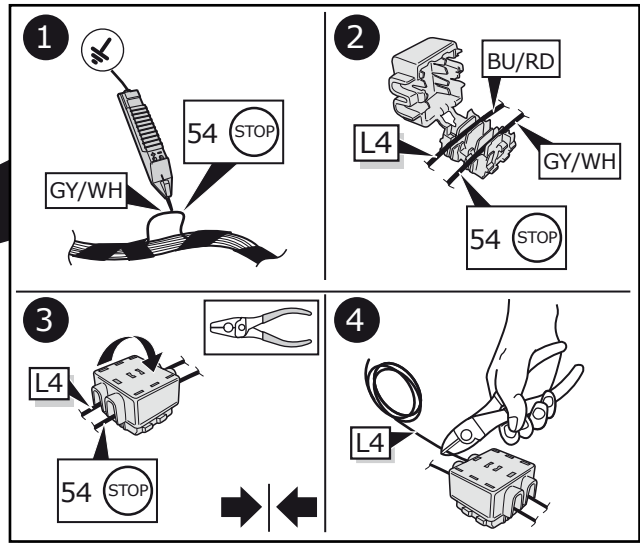
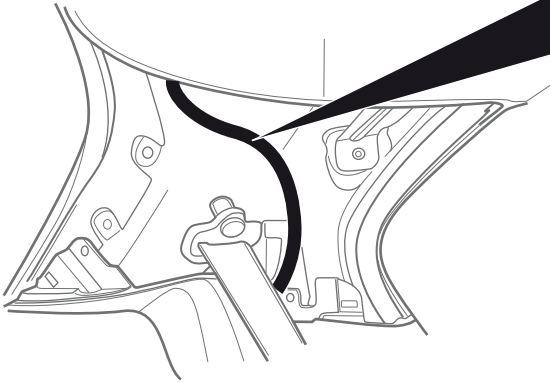
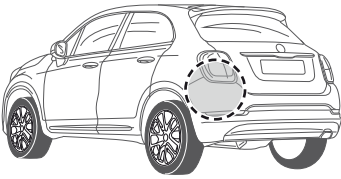

24

Jeep Renegade

Jeep Renegade Hybrid

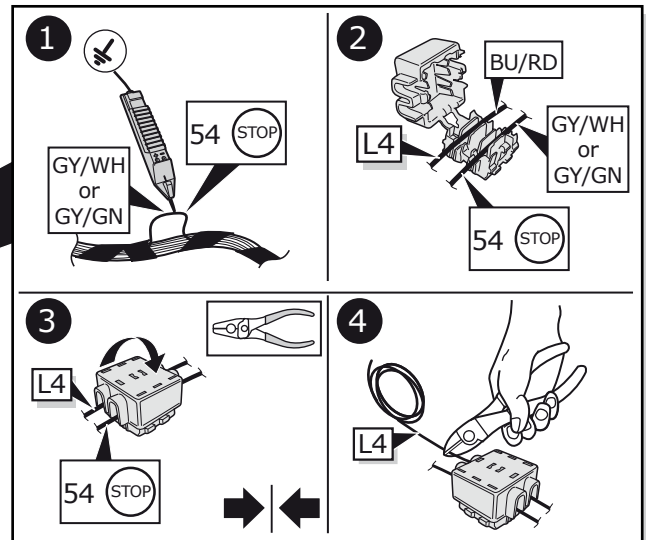
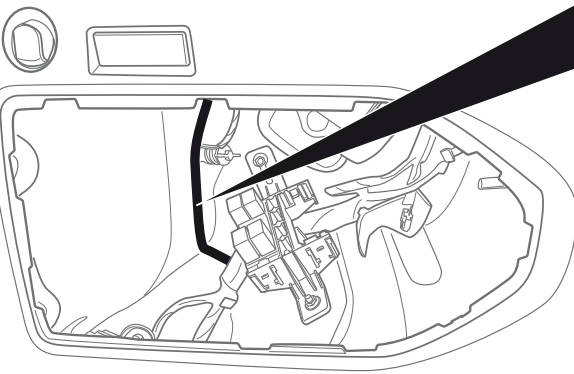
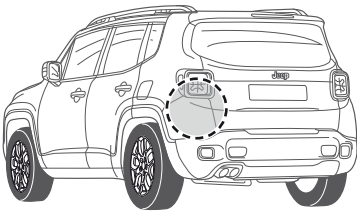

25

Jeep Compass

Jeep Compass Hybrid

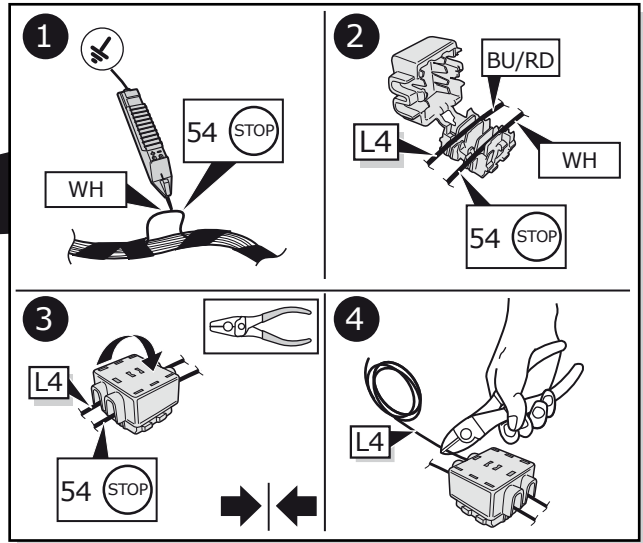
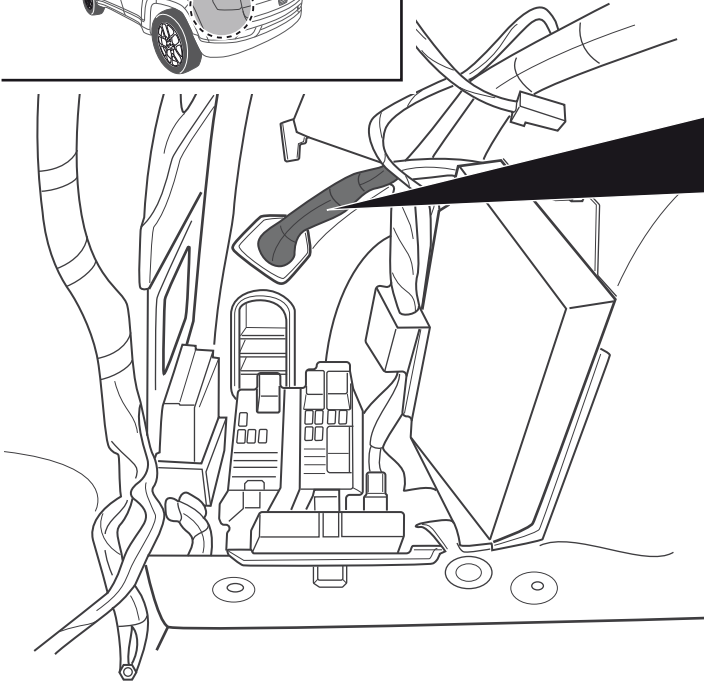
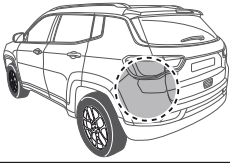

26

Jeep Compass

Jeep Compass Hybrid

Jeep Renegade Hybrid

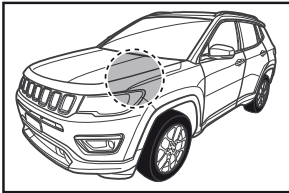

Vehicles with Factory-Fitted PDC-System

Fahrzeuge mit werkseitig eingebauter Einparkhilfe

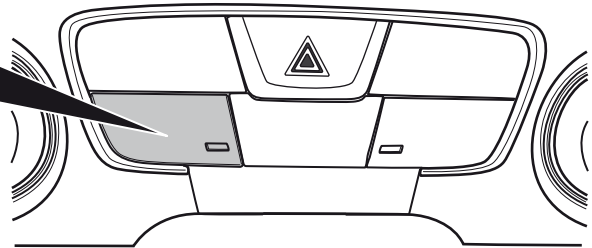
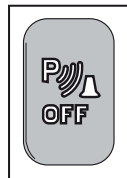
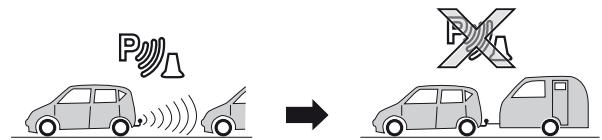

Not needed!
Wird nicht benötigt!

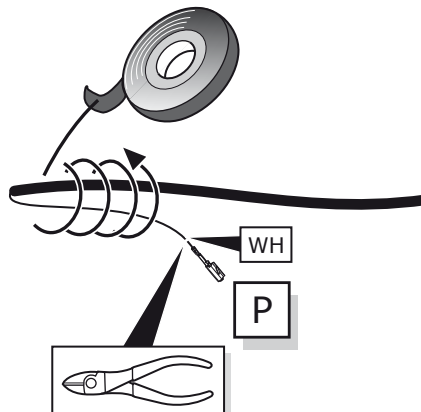

27

Fiat 500 X



Jeep Renegade

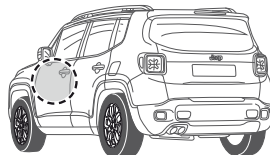

- (GB) In case of a vehicle with blind spot detection, PDC cut-off via switch on dashboard.
- (NL) In geval van een voertuig met blind spot detection, PDC uitschakelbaar via switch op dashboard.
- (DE) Im Falle eines Fahrzeug Blind Spot Detection, Kann PDC über den Schalter am Armaturenbrett ausgeschaltet werden.
- (FR) Pour véhicule avec capteurs d'angles mort, désactivation des feux de radar par interrupteur du véhicule.

28

Fiat 500 X



Jeep Renegade

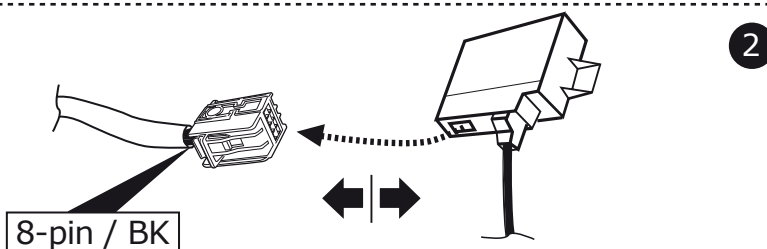
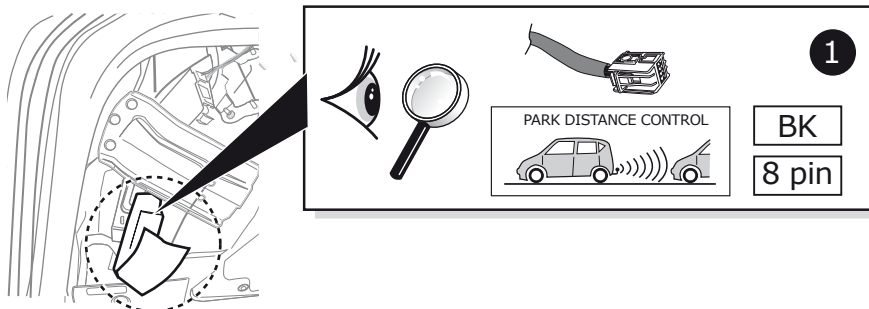
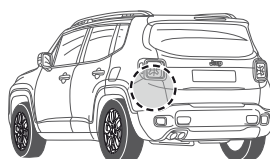

29

Fiat 500 X

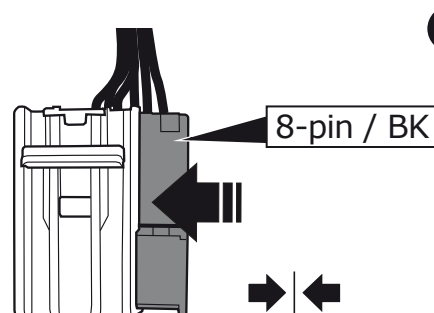
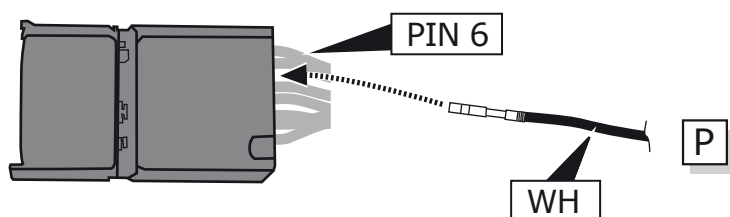
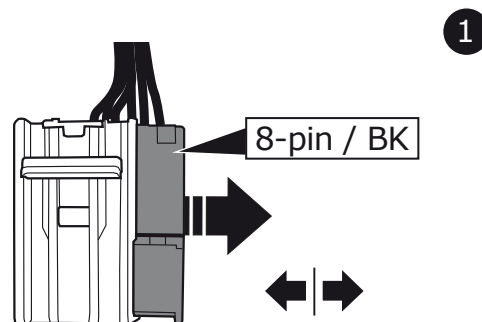
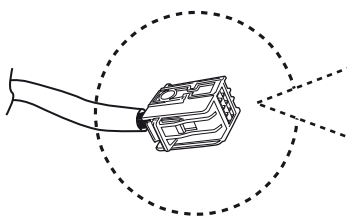
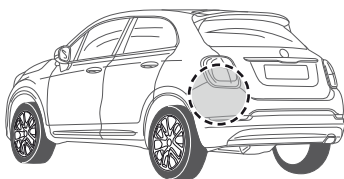

30

Jeep Renegade

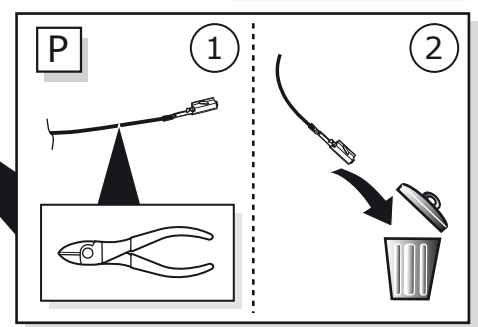
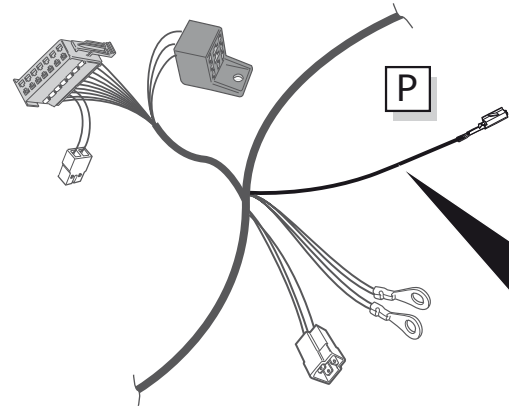
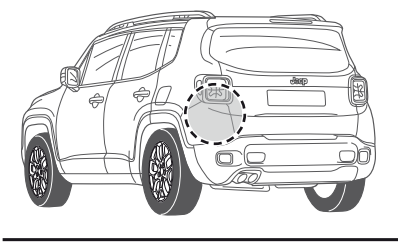

31

Jeep Renegade

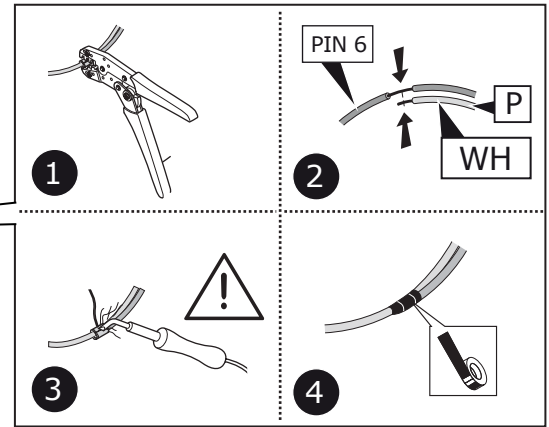
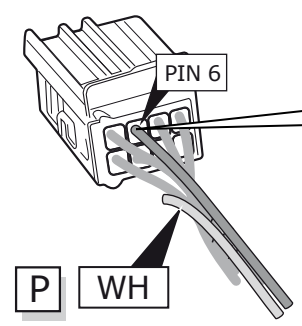
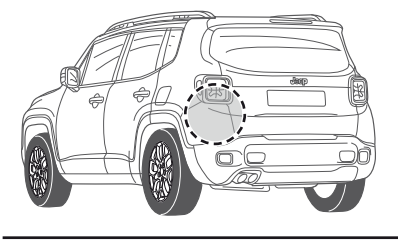

32

Fiat 500 X

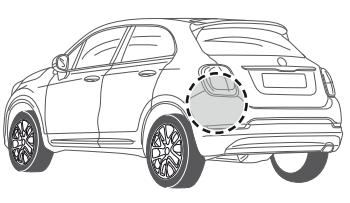

Jeep Renegade

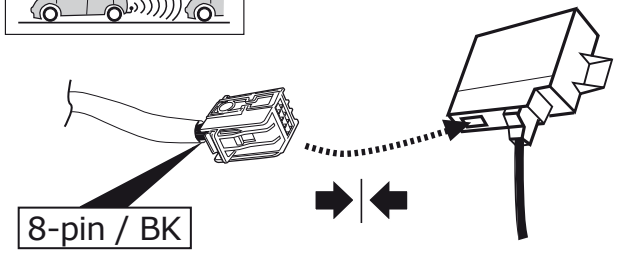
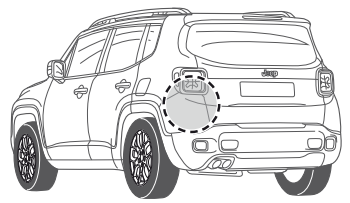

33

Fiat 500 X

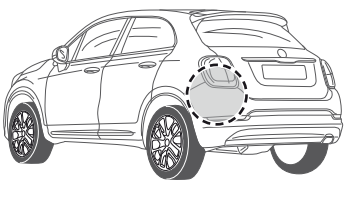

Jeep Renegade

Jeep Renegade Hybrid

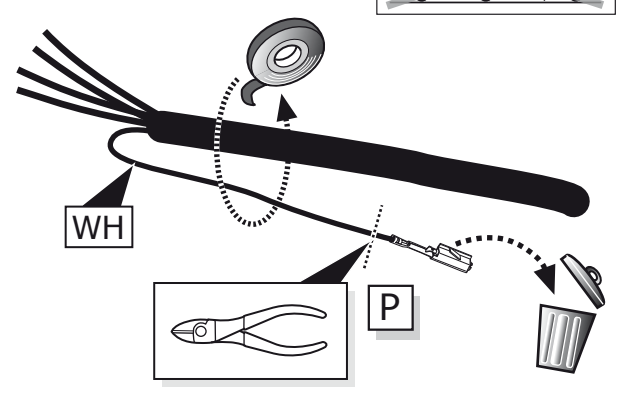
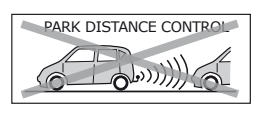
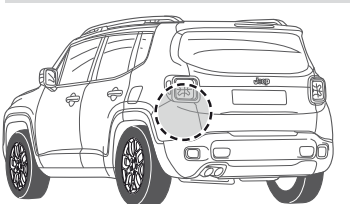

34

Fiat 500 X

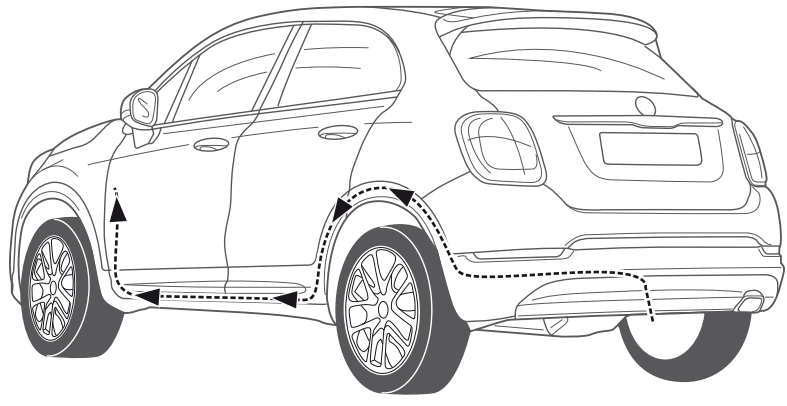

Jeep Compass

Jeep Compass Hybrid

Jeep Renegade

Jeep Renegade Hybrid

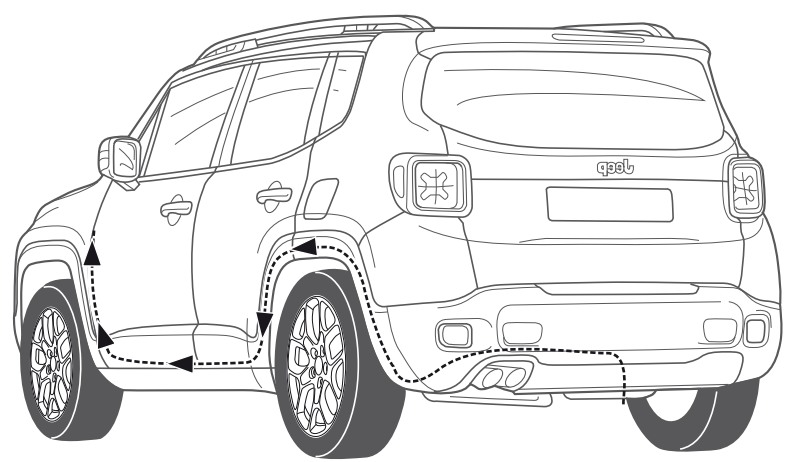

35

Fiat 500 X

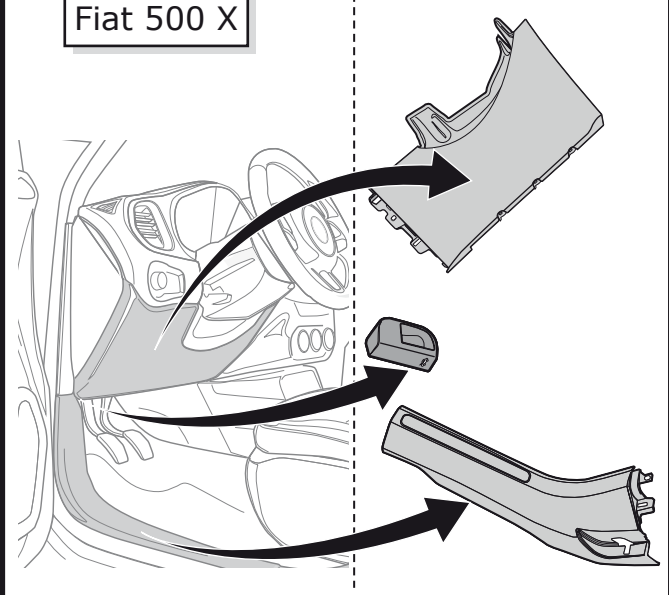

Jeep Compass

Jeep Compass Hybrid

Jeep Renegade

Jeep Renegade Hybrid

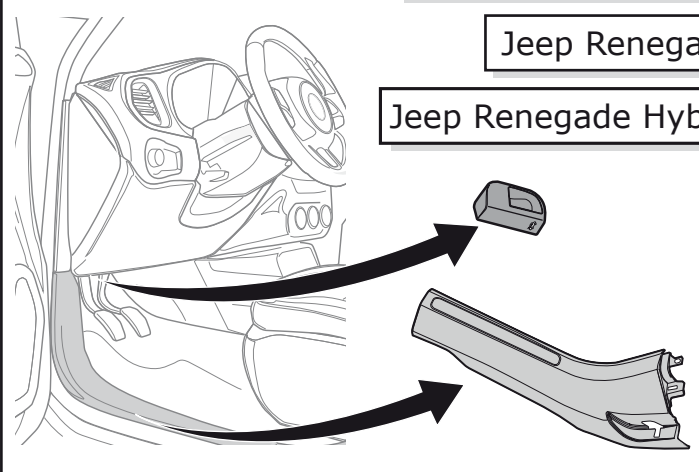

36

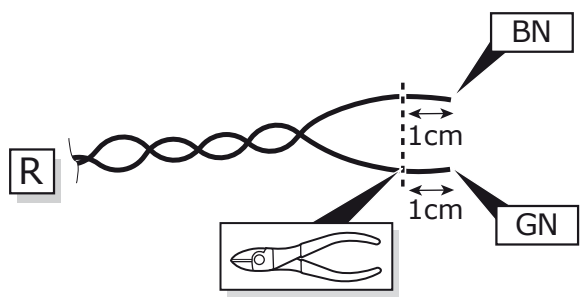

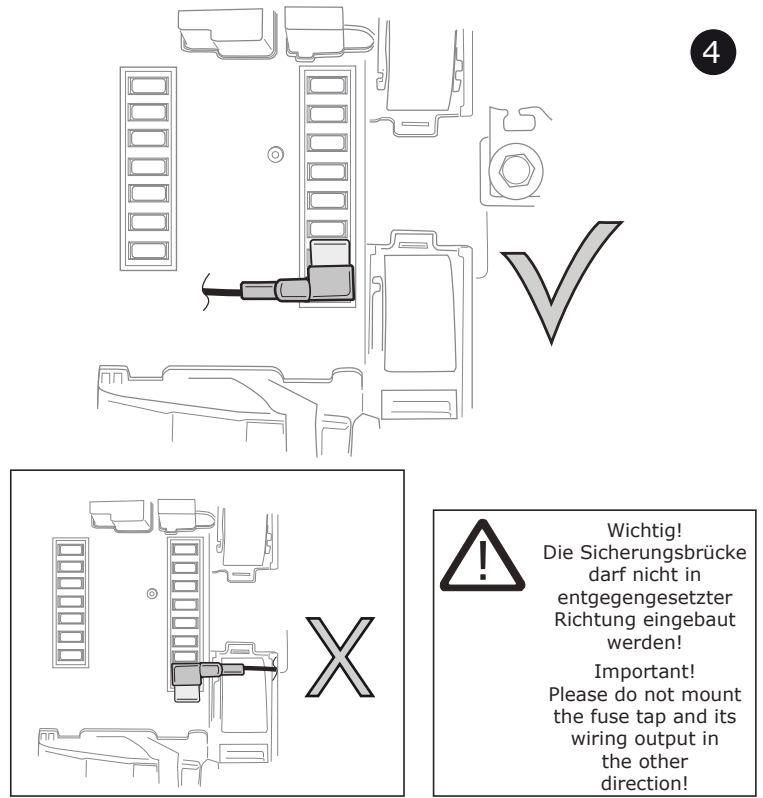
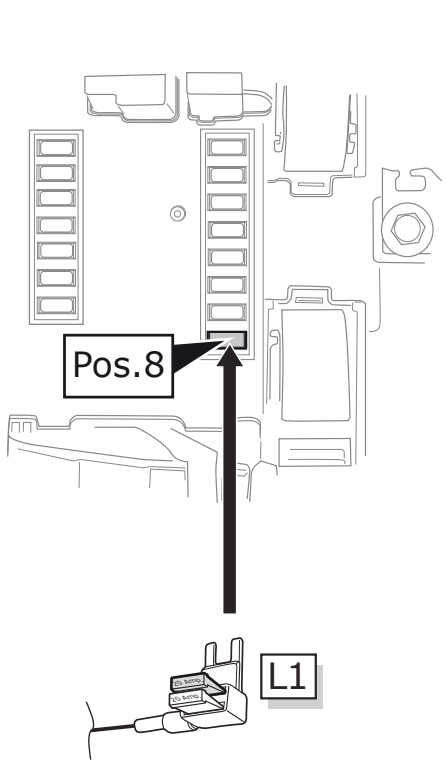
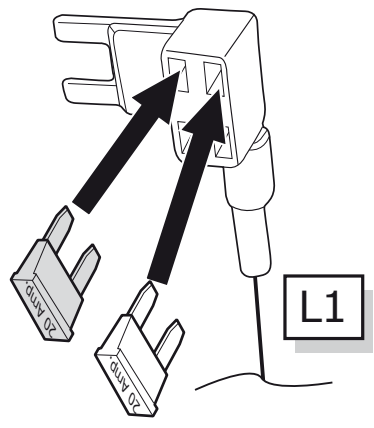
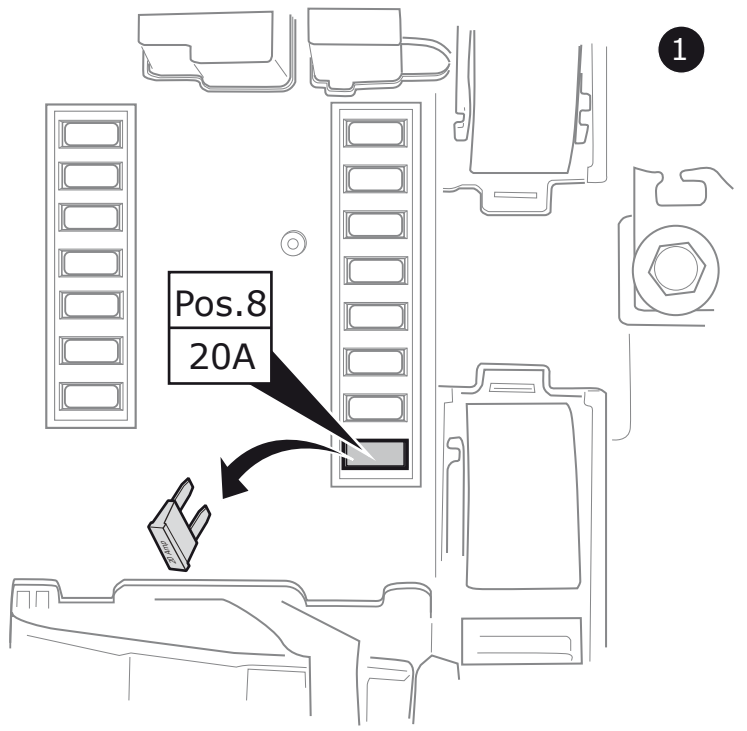
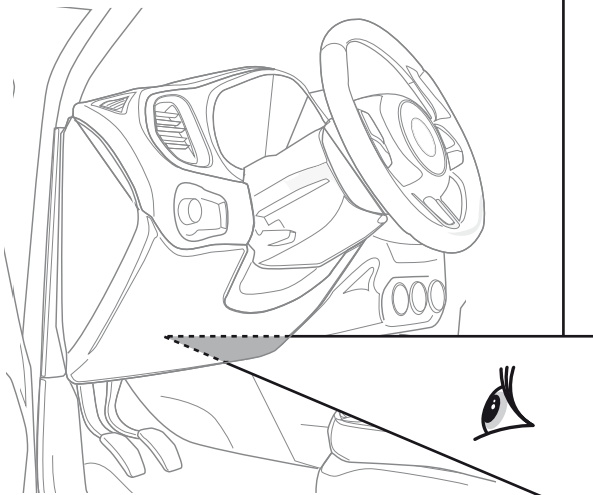

 **Wichtig!**
Die Sicherungsbrücke darf nicht in entgegengesetzter Richtung eingebaut werden!
Important!
Please do not mount the fuse tap and its wiring output in the other direction!

CAN bus connection
CAN Bus Anbindung

Fiat 500 X

Jeep Compass

Jeep Compass Hybrid

Jeep Renegade

Jeep Renegade Hybrid

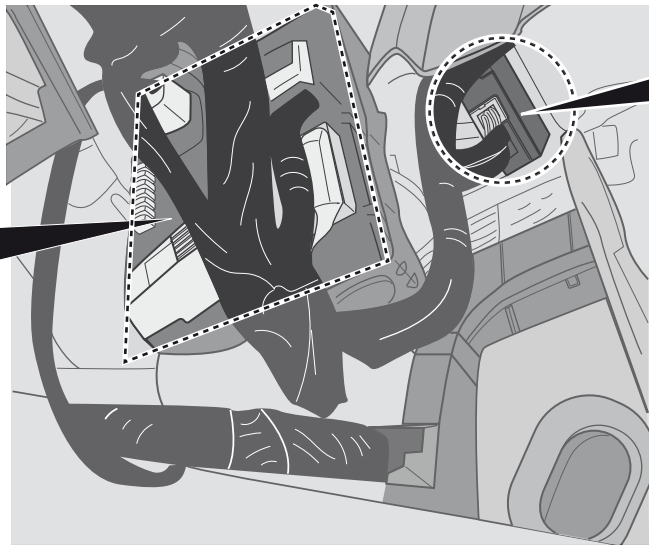

BCM
(Body control Module)

SGW
(Security Gate Way)

SGW Security Gate Way

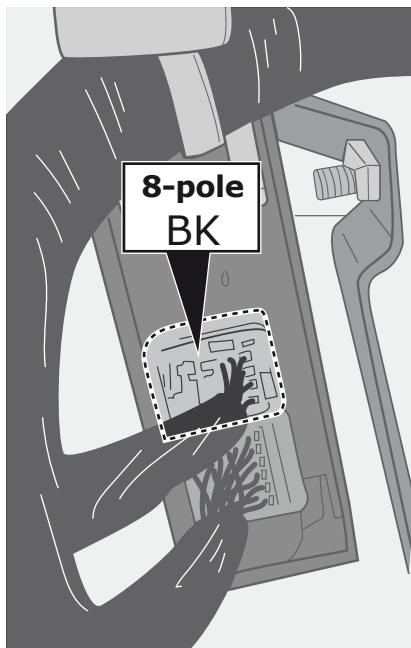

SGW
not fitted
nicht verbaut



39
41 - 47

SGW
fitted
verbaut



40 - 47



Without Security Gate Way
Ohne Security Gate Way

Fiat 500 X

Jeep Compass

Jeep Compass Hybrid

Jeep Renegade

Jeep Renegade Hybrid

OBD

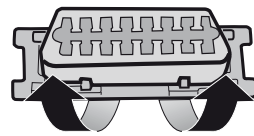

CAN-Data Wire



PIN3
PIN11

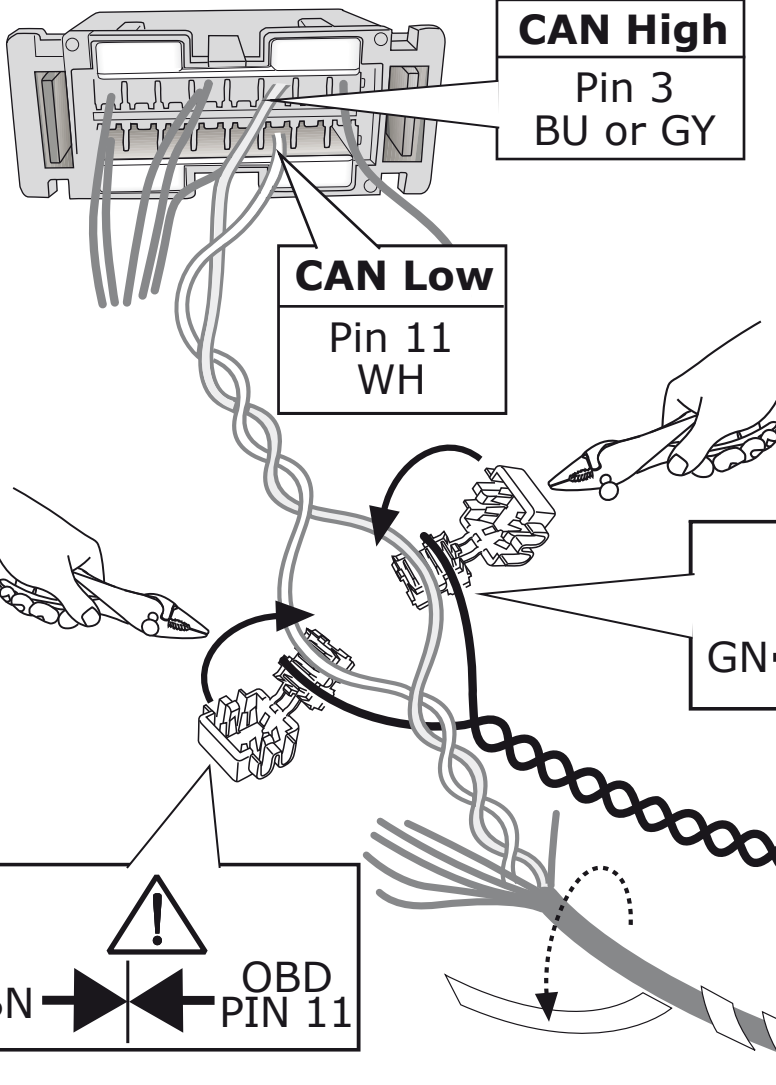

Important!
Please note
infomations in
picture 1!

Wichtig!
Unbedingt Hinweise
aus Bild 1 beachten!

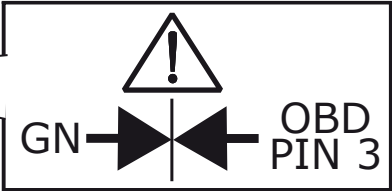

BN
GN R



With Security Gate Way
Mit Security Gate Way

Fiat 500 X

Jeep Compass

Jeep Compass Hybrid

Jeep Renegade

Jeep Renegade Hybrid

SGW Security Gate Way

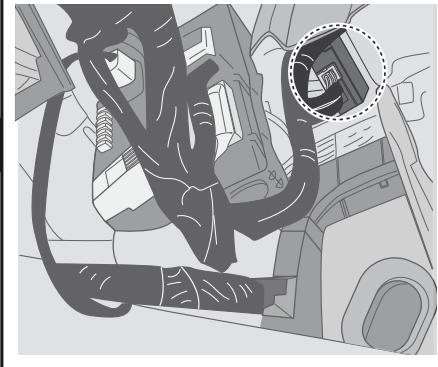

Important!
Please note
informations in
picture 1!

Wichtig!
Unbedingt Hinweise
aus Bild 1 beachten!

CAN-Data Wire



PIN3
PIN8



CAN High

Pin 3
BU or PE/WH

CAN Low

Pin 8
WH or YE/BU

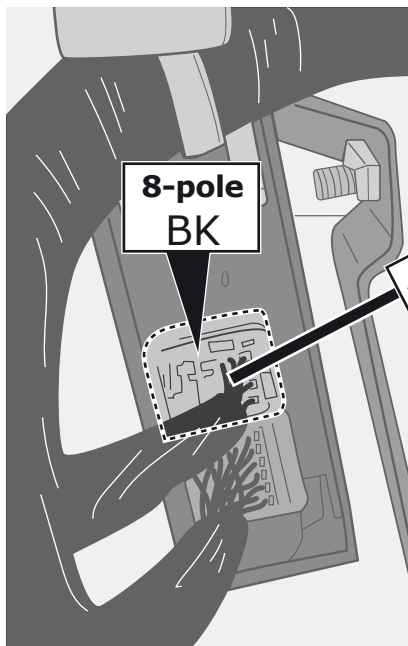

8-pole
BK

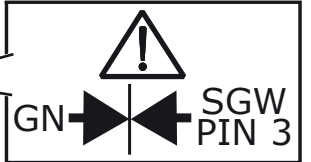
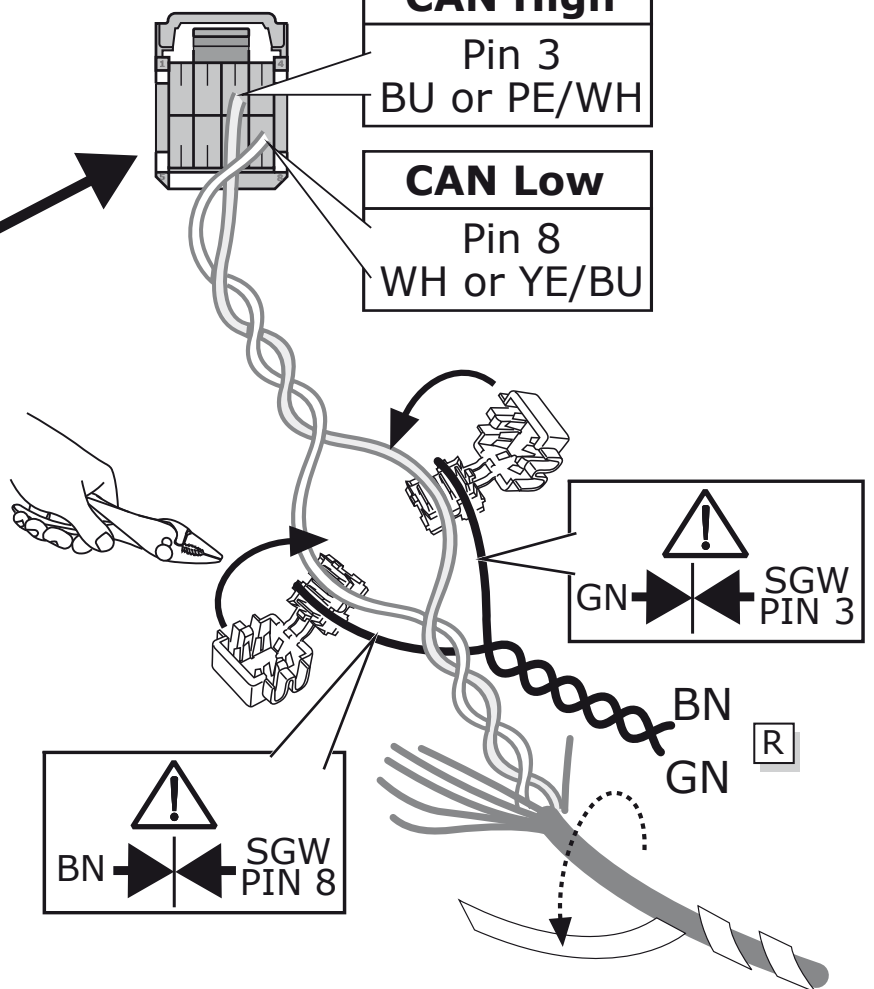

41

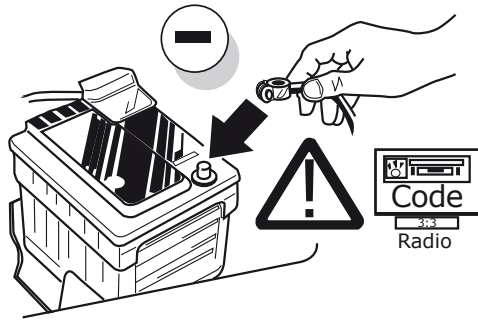

42

Functional test

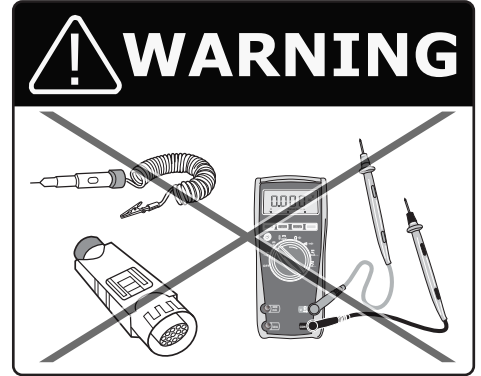
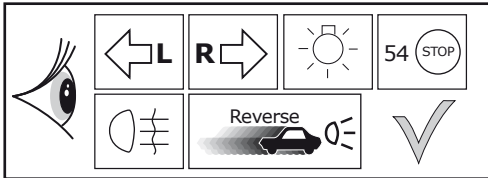

LIGHTMATE®

ECS part no.
LIGHTMATEII
LIGHTMATEIII

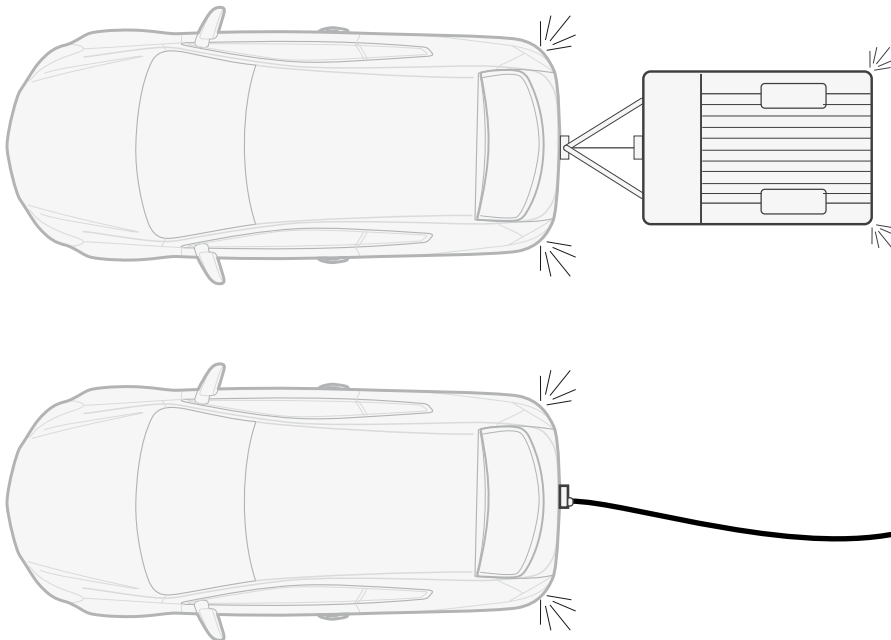

43

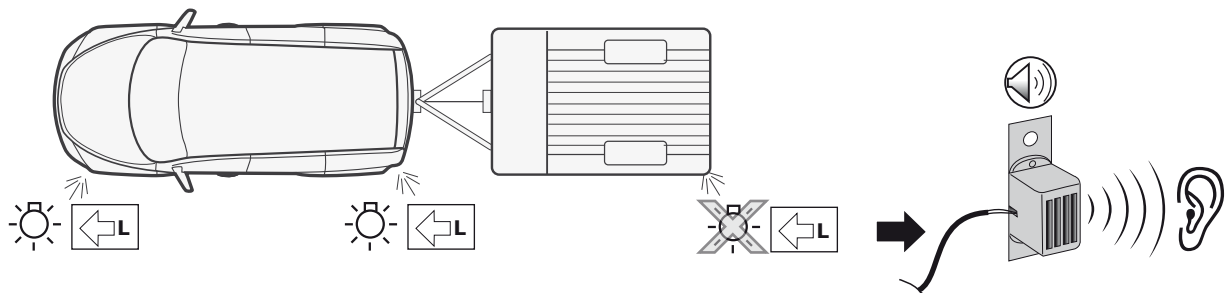
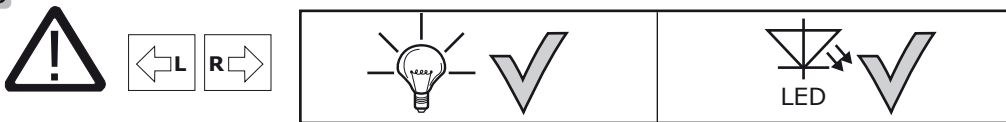

44



54 STOP

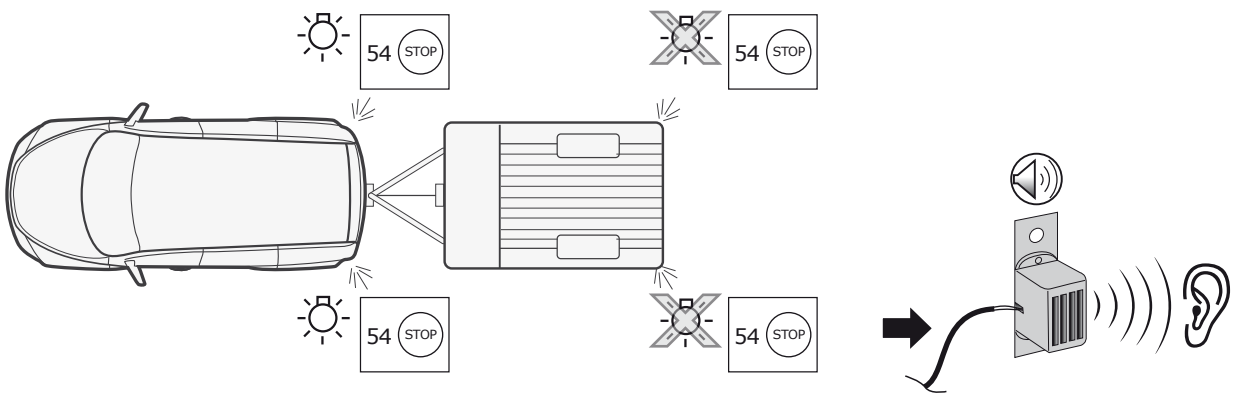
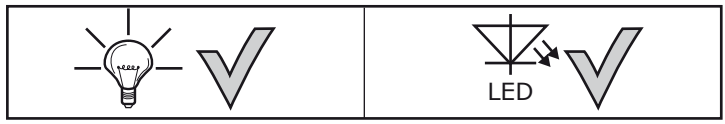

45

Optional

Adapter socket

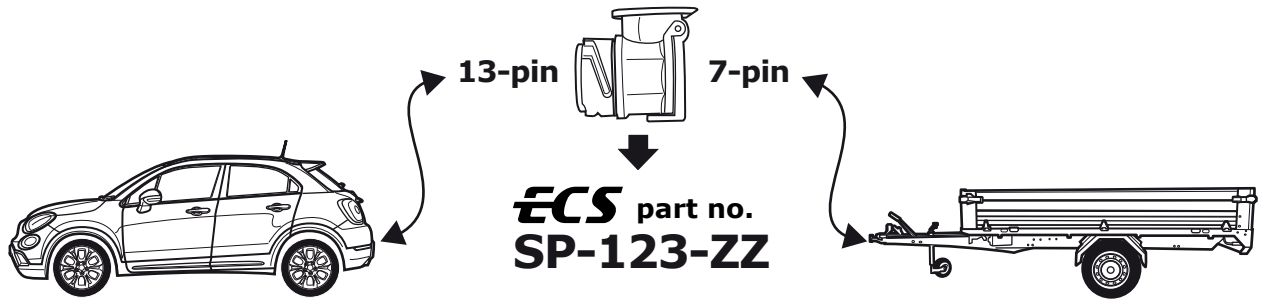

46

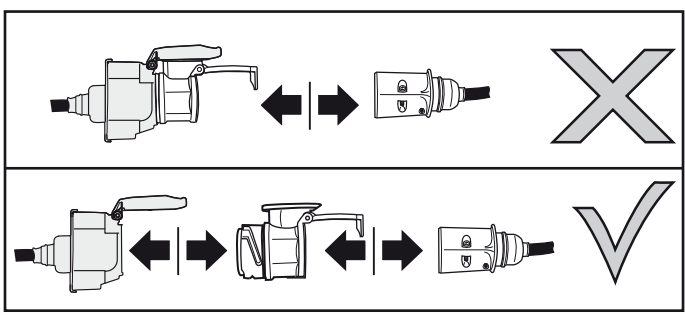
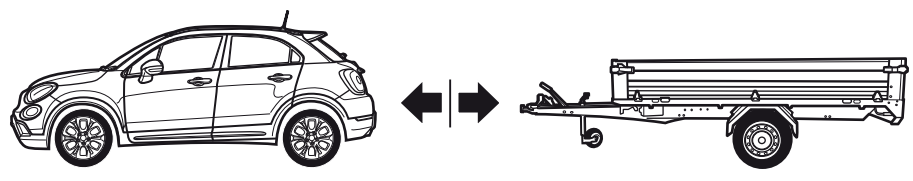

Products & Service: www.ecs-electronics.nl

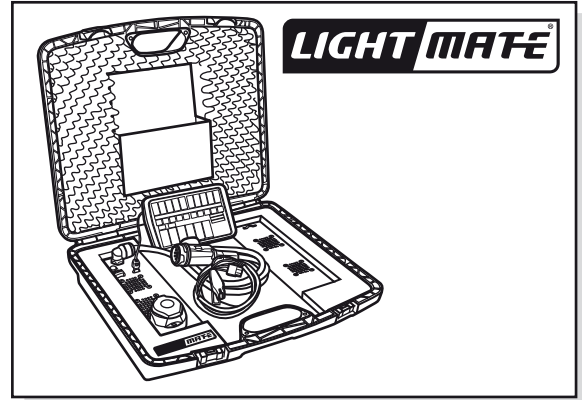
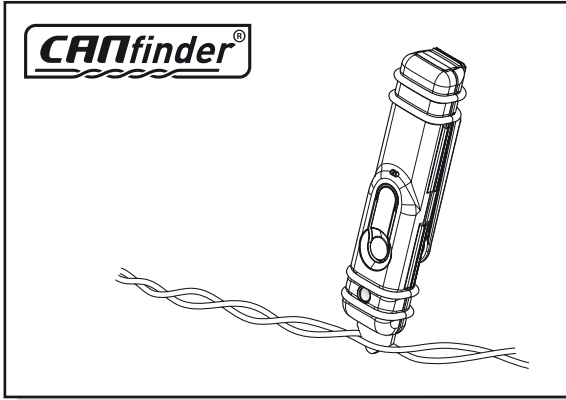

- Ⓓ Einzelteile wieder einbauen
- Ⓕ Remonter les pièces démontées
- Ⓖ Terug plaatsen onderdelen
- Ⓖ Reinstall linings
- Ⓔ Reinstalar componentes
- Ⓘ Rimetti a posto componenti



- (DE) Anschluss Steckdose (ES) Conexión de la caja de enchufe (CZ) Objímkový konektor (GR) Υποδοχή σύνδεσης
 (FR) Connection de la prise (IT) Allaccio zoccolo (DK) Stikdåse forbindelse (NO) Tilkobling koblingsboks
 (NL) Contactdoos aansluiting (SE) Anslutning kontaktdosa (FI) Pistorasia liitäntä (PL) Połączenie przez gniazdo
 (GB) Socket connection

DIN/ISO 11446	↩		≡ 1-8	↗				⊙				≡ 10	—	≡ 9
Pmax	1/L 21W	2 21W	3/31 21W	4/R 21W	5/58-R 42W	6/54 3x21W	7/58-L 42W	8 21W	9 180W/15Amp.	10 180W/15Amp.	11 13	12	13	
(DE)	Gelb	Blau	Weiß	Grün	Braun	Rot (1,00mm ²)	Schwarz	Schwarz/ Rot	Braun/ Weiß	Rot (2,50mm ²)	Weiß	Rot/ Blau	Weiß	
(FR)	Jaune	Bleu	Blanc	Vert	Marron	Rouge (1,00mm ²)	Noir	Noir/ Rouge	Marron/ Blanc	Rouge (2,50mm ²)	Blanc	Rouge/ Bleu	Blanc	
(NL)	Geel	Blauw	Wit	Groen	Bruin	Rood (1,00mm ²)	Zwart	Zwart/ Rood	Bruin/ Wit	Rood (2,50mm ²)	Wit	Rood/ Blauw	Wit	
(GB)	Yellow	Blue	White	Green	Brown	Red (1,00mm ²)	Black	Black/ Red	Brown/ White	Red (2,50mm ²)	White	Red/ Blue	White	
(ES)	Amarillo	Azul	Blanco	Verde	Marrón	Rojo (1,00mm ²)	Negro	Negro/ Rojo	Marrón/ Blanco	Rojo (2,50mm ²)	Blanco	Rojo/ Azul	Blanco	
(IT)	Giallo	Blu	Bianco	Verde	Marrone	Rosso (1,00mm ²)	Nero	Nero/ Rosso	Marrone/ Bianco	Rosso (2,50mm ²)	Bianco	Rosso/ Blu	Bianco	
(SE)	Gul	Blå	Vit	Grön	Brun	Röd (1,00mm ²)	Svart	Svart/ Röd	Brun/ Vit	Röd (2,50mm ²)	Vit	Röd/ Blå	Vit	
(CZ)	Žlutá	Modrá	Bílá	Zelená	Hnědá	Červená (1,00mm ²)	Černá	Černo/ Červená	Hnědo/ Bílá	Červená (2,50mm ²)	Bílá	Červeno/ Modrá	Bílá	
(DK)	Gul	Blå	Hvid	Grøn	Brun	Rød (1,00mm ²)	Sort	Sort/ Rød	Brun/ Hvid	Rød (2,50mm ²)	Hvid	Rød/ Blå	Hvid	
(FI)	Keltainen	Sininen	Valkoinen	Vihreä	Ruskea	Punainen (1,00mm ²)	Musta	Musta/ Punainen	Ruskea/ Valkoinen	Punainen (2,50mm ²)	Valkoinen	Punainen/ Sininen	Valkoinen	
(GR)	Κίτρινο	Μπλε	Λευκό	Πράσινο	Καφέ	Κόκκινο (1,00mm ²)	Μαύρο	Μαύρο/ Κόκκινο	Καφέ/ Λευκό	Κόκκινο (2,50mm ²)	Λευκό	Κόκκινο/ Μπλε	Λευκό	
(NO)	Gul	Blå	Hvit	Grønn	Brun	Rød (1,00mm ²)	Svart	Svart/ Rød	Brun/ Hvit	Rød (2,50mm ²)	Hvit	Rød/ Blå	Hvit	
(PL)	Żółty	Niebieski	Biały	Zielony	Brązowy	Czerwony (1,00mm ²)	Czarny	Czarny/ Czerwony	Brązowy/ Biały	Czerwony (2,50mm ²)	Biały	Czerwony/ Niebieski	Biały	