

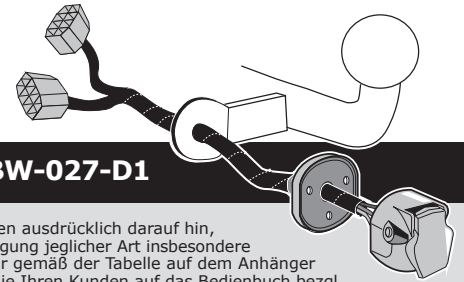

**MINI**  
**F54 Clubman**  
**F60 Countryman**

**10/2015>>**

**02/2017>>**



**Partnr.: BW-027-D1**

- DE** • Einbauanleitung Elektrosatz Anhängervorrichtung mit 13-P Steckdose lt. DIN/ISO Norm 11446. • Wir weisen ausdrücklich darauf hin, dass eine unsachgemäße und nicht in einer Fachwerkstatt durchgeführte Montage einen Verzicht auf Entschädigung jeglicher Art insbesondere bezüglich des Produkthaftpflichtrechts zur Folge hat. • Technische Änderungen vorbehalten. • Widerstand nur gemäß der Tabelle auf dem Anhänger verwenden. • Achtung! Bitte lesen Sie vorab diese Anleitung, nehmen Sie diese zur Kenntnis und verweisen Sie Ihren Kunden auf das Bedienbuch bezgl. der eventuell zu treffenden Maßnahmen zum Ziehen eines Anhängers. • Bei Funktionsproblemen ist die Fehlersuche auf ca. 0,5 Stunden zu begrenzen, kontaktieren Sie die ECS Technical Support: [ts@ecs-electronics.nl](mailto:ts@ecs-electronics.nl) / 00800 22552327
- FR** • Instructions de montage du faisceau électrique pour crochet d'attelage conforme à la norme DIN/ISO 11446 prise 13-P. • Il est expressément prévu qu' on ne saurait se prévaloir d'un quelconque préjudice contractuel ou réhibitoire si le montage avait été fait en dépit des dites instructions ou dans un garage ne disposant pas des équipements adéquats. • Sous réserve de modifications techniques. • Ne excédez pas la charge maximale, indiquée dans le tableau. • Attention! Avant de commencer le branchement, on vous prie de prendre compte des connections à faire dans la notice, ainsi que communiquer directement à votre client les mesures à prendre pour tirer une remorque. • S'il y a des problèmes de fonctionnement, limiter la recherche de défauts à env. 30 minutes et contacter ECS l'Aide en ligne: [ts@ecs-electronics.nl](mailto:ts@ecs-electronics.nl) / 00800 22 55 23 27.
- NL** • Montage-handleiding elektrokabelset voor trekhaak met 13-P contactdoos vlg. DIN/ISO norm 11446. • Wij wijzen er met nadruk op, dat ondeskundige en niet door een vakkundige werkplaats uitgevoerde montage tot gevolg heeft dat daardoor ieder recht op schadevergoeding, ook op wettelijke aansprakelijkheid inzake producten, vervalt. • Technische wijzigingen voorbehouden. • Gebruik alleen belasting volgens aansluittabel op het getrokken voertuig. • Opgelet! Wij verzoeken U dringend vooraf deze instructie door te nemen, hiervan kennis te nemen en uw cliënt te verwijzen naar het instructieboekje betreffende de eventueel te nemen maatregelen voor het trekken van een aanhangwagen. • Bij werkingsproblemen moet de foutencontrole tot ca. 0,5 uur beperkt worden, neem contact op met de ECS Technical Support: [ts@ecs-electronics.nl](mailto:ts@ecs-electronics.nl) / 00800 22 55 23 27.
- GB** • Fitting instructions electric wiring kit tow bar with 13-P socket up to DIN/ISO Norm 11446. • We would expressly point out that assembly not carried out properly by a competent installer will result in cancellation of any right to damage compensation, in particular those arising by virtue of the product liability act. • Contents of these kits and their fitting manuals are subject to alteration without notice, please ensure that these instructions are read and fully understood before commencing installation. • Do not overload circuits; the maximum loads per connection are detailed in this manual. • Attention! Before Installation, please read this manual carefully and inform your customer to consult the vehicle owners manual to check for any vehicle modifications required before towing. • In the event of functional problems, troubleshooting must be limited to about 0.5 hours, contact the ECS Technical Support: [ts@ecs-electronics.nl](mailto:ts@ecs-electronics.nl) / 00800 22 55 23 27.
- ES** • Instrucciones de montaje de kit eléctrico para enganche de remolque con caja de conexiones 13-P según norma DIN/ISO 11446. • El montaje inapropiado y efectuado por personal no cualificado originará la pérdida de todo derecho a indemnización o la expiración de toda responsabilidad civil con respecto al producto. • Nos reservamos el derecho a efectuar modificaciones técnicas. • Utilice sólo cargas de acuerdo a la tabla de conexión del vehículo remolcado. • Atención: lea atentamente este manual antes de la instalación e informe al cliente que debe consultar el manual de usuario del vehículo para conocer cualquier modificación realizada. • En caso de tener problemas con su funcionamiento, la búsqueda de errores está limitada a aprox. 0,5 horas, por lo que le recomendamos ponerse en contacto con el servicio de atención telefónica: [ts@ecs-electronics.nl](mailto:ts@ecs-electronics.nl) / 00800 22 55 23 27.
- IT** • Istruzioni di montaggio di set di cavi elettrici per gancio da traino con zoccolo a 13-P conforme alla norma DIN/ISO 11446. • Sottolineiamo espressamente che un montaggio inadeguato ed eseguito da un'officina non specializzata ha come conseguenza il decadere di qualsiasi diritto al risarcimento danni, nonché alla responsabilità legale relativa ai prodotti. • Ci si riserva il diritto di apportare modifiche tecniche. • Utilizzare esclusivamente un carico conforme alla tabella degli allacci relativa al veicolo in questione. • Attenzione! Vi invitiamo a leggere attentamente questo manuale e a invitare a vostra volta i clienti a leggere il manuale del conducente sulle eventuali misure da prendere per l'attacco di un rimorchio. • In caso di problemi di funzionamento, la ricerca di errori dovrebbe essere limitata a circa 0,5 ore. Contattare il centralino di assistenza per i fasci di cavi: [ts@ecs-electronics.nl](mailto:ts@ecs-electronics.nl) / 00800 22 55 23 27.
- SE** • Monteringsanvisningar elkabelsats för dragkrok med 13-P kontaktlåsa enligt DIN/ISO norm 11446. • Vi påpekar med eftertryck att all rätt till skadeersättning och all laglig ansvarighet förfaller om monteringen inte har utförts på rätt sätt och av en professionell verkstad. • Tekniska ändringar förbehålles. • Använd endast belastning enligt anslutningstabellen på det dragna fordonet. • Varning! Innan installation, läs den här handboken noga och informera din kund om att läsa fordonets användarhandbok för att undersöka vilka eventuella ändringar som behöver göras på fordonet. • Vid funtionsproblem ska felsökningen begränsas till ca 0,5 timme, kontakta reservdels-helpline [ts@ecs-electronics.nl](mailto:ts@ecs-electronics.nl) / 00800 22 55 23 27.
- CZ** • Montážní pokyny: souprava pro elektrické propojení tažné tyče s 13-P zásuvkou do normy DIN/ISO 11446. • Výslovně zdůrazňujeme, že jakákoli montáž, která není provedená ve specializované dílně, má za následek odvolání nároků na kompenzaci jakéhokoli druhu, obzvláště vyplývajících ze zákona o odpovědnosti za způsobené škody. • Změny mohou být provedeny bez oznámení. • Používejte pouze při maximálním nabití podle tabulky na tažném vozidle. • Upozornění! Prosíme, abyste si nejdříve přečetli tyto instrukce, seznámili se s nimi a odkázali své zákazníky na příručku týkající se případných opatření, která musí být přijata pro tažení přívěsu. • Při problémech funkčnosti je třeba vyhledávání chyb omezit na cca 0,5 hodiny, kontaktujte ECS Technical Support: [ts@ecs-electronics.nl](mailto:ts@ecs-electronics.nl) / 00800 22 55 23 27.
- DK** • Monteringsvejledninger for det elektriske ledningsføringssæt for trækstang med 13-P stikdåse, DIN/ISO, norm 11446. • Vi ønsker at gøre udtrykkeligt opmærksom på atforkert samling, der ikke er udført af et specialiseret værksted, resulterer i bortfaldelse af kompenseringskrav af alle slags, i særdeles krav der måtte opstå omkring det lovligtige ansvar. • Kan ændres uden varsel. • Brug kun den maksimale belastning, i overensstemmelse med forbindelsestabelen for bugserede køretøjer. • OBS! For installation skal denne vejledning læses omhyggeligt og din kunde skal informeres om at kigge i køretøjets håndbog for at kontrollere om der skal laves eventuelle ændringer på køretøjet inden bugsering. • Ved funktionsproblemer skal fejlsøgningen begrænses til ca. 0,5 time, kontakt ECS Technical Support: [ts@ecs-electronics.nl](mailto:ts@ecs-electronics.nl) / 00800 22 55 23 27.
- FI** • Ohjeet vetokoukun sähkökaapelisarjan asentamiseen, jossa on DIN/ISO 11446 mukainen 13-P liitin. • Korostamme, että kaikki oikeudet vahinkokorvaukseen kuten myös valmistajan laillinen vastuu raukeavat, mikäli asennusta ei ole toteutettu oikealla tavalla eikä ammattitaitoisen asiantuntijan toimesta. • Oikeus teknisiin muutoksiin ilman erillistä huomautusta pidätetään. • Huomio! Lue tämä käyttöoppas huolellisesti ennen asennusta ja tiedota asiakkaita tarkistamaan kaikki ajoneuvon muutoksen ajoneuvon omistajan käyttöoppaas ennen hinausta. • Kuormita työvirtapiiriä ainoastaan hinattavan ajoneuvon kytkentäkaavin mukaisesti. • Virhehaku on rajoitettava toiminto-ongelmien esiintyessä noin 0,5 tuntiin, ota yhteys ECS Technical Support: [ts@ecs-electronics.nl](mailto:ts@ecs-electronics.nl) / 00800 22 55 23 27.
- GR** • Οδηγίες συναρμολόγησης ηλεκτρικού σετ καλωδίων μπάρας ρυμούλκησης με υποδοχή 13-P μέχρι DIN/ISO Κανόνας 11446. • Επισημαίνουμε κατηγορηματικά ότι οποιαδήποτε ασφαλή συναρμολόγηση, η οποία δεν έχει πραγματοποιηθεί ειδικό εργαστήριο θα οδηγήσει σε απονομή των αξιόσων επιβολής αποζημιώσεων οποιοδήποτε είδους, ειδικά όσα προκύπτουν από το νόμο ευθύνης προϊόντων. • Μπορεί να τροποποιηθεί χωρίς προηγούμενη ειδοποίηση. • Χρησιμοποιείτε μόνο μέγιστο ηλεκτρικό φορτίο σύμφωνα με τον πίνακα σύνδεσης στο ρυμούλκούμενο όχημα. • Προσοχή! Πριν την εγκατάσταση, διαβάστε το εγχειρίδιο αυτό προσεκτικά και ενημερώστε τον πελάτη σας να συμβουλευτεί το εγχειρίδιο ιδιοκτητών οχήματος ώστε να ελέγξει τυχόν τροποποιήσεις που απαιτούνται στο όχημα πριν τη ρυμούλκηση. • Σε περίπτωση προβλημάτων λειτουργίας να περιοριστεί η αναζήτηση ασφαλμάτων σε περί. 0,5 δευτ., επικοινωνήστε με τη γραμμή υποστήριξης ECS Technical Support: [ts@ecs-electronics.nl](mailto:ts@ecs-electronics.nl) / 00800 22 55 23 27.
- NO** • Monteringsanviser elkabelsett for trekkrok med 13-P koblingsboks ifølge DIN/ISO norm 11446. • Vi påpeker ettertrykkelig at all rett til skadeerstatning og rettslig ansvar forfaller dersom monteringen ikke er blitt utført på riktig måte og av et profesjonelt verksted. • Tekniske endringer forbeholdes. • Overskrid ikke grensene anviset i tilkoblingstabellen på tilhengeren eller det tilkoblede kjøretøyet. • OBS! Les denne bruksanvisningen nøye før installasjon. Be kunden om å rådføre seg med brukerhåndboken for kjøretøyeiere for å sjekke om kjøretøyet må modifiseres før tauing. • Ved funksjonsproblemer må feilsøket begrenses til ca. 0,5 timer, kontakt ECS Technical Support: [ts@ecs-electronics.nl](mailto:ts@ecs-electronics.nl) / 00800 22 55 23 27.
- PL** • Instrukcje montażu zestawu okablowania elektrycznego dysza holowniczego z 13-P stykiem gniazdem DIN/ISO 11446. • Chcielibyśmy wyraźnie zaznaczyć, iż wszelki nieprawidłowy montaż, który nie jest wykonywany w specjalistycznym warsztacie posiada z sobą utratę możliwości dochodzenia wszelkiego typu roszczeń, w szczególności tych wynikających z odpowiedzialności producenta za swój produkt. • Podlega zmianom bez powiadomienia. • Używać tylko takiego maksymalnego obciążenia które wynika z tabliczki połączeń holowanego pojazdu. • Uwaga! Przed zainstalowaniem należy dokładnie przeczytać tę instrukcję i poinformować klienta o konieczności sprawdzenia w instrukcji posiadacza pojazdu w celu sprawdzenia przed holowaniem, czy nie wprowadzono do pojazdu jakichkolwiek zmian. • W przypadku problemów ograniczyć wyszukiwanie błędów do ok. 0,5 godziny, skontaktować się z linią serwisową [ts@ecs-electronics.nl](mailto:ts@ecs-electronics.nl) / 00800 22 55 23 27.

Einzelteilliste

Liste de pièces

Onderdelenlijst

Part list

Lista de componentes

Elenco componenti

Dellista

Seznam dílů

Del-liste

Osaluettelo

Κατάλογος εξαρτημάτων

Delliste

Lista części

(DE)

(FR)

(NL)

(GB)

(ES)

(IT)

(SE)

(CZ)

(DK)

(FI)

(GR)

(NO)

(PL)

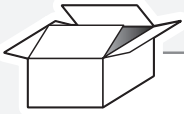

U

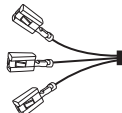

B



G

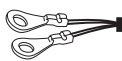

D



C

A

X

X

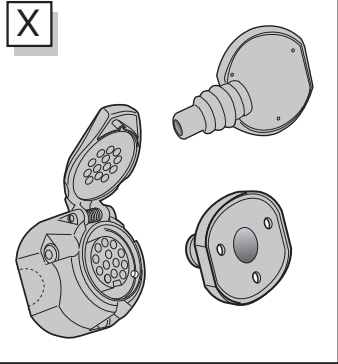

T

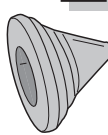

M



M



5x

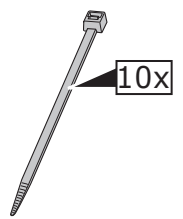
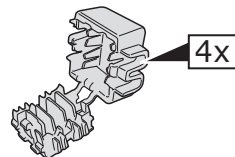
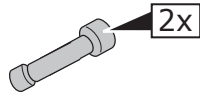
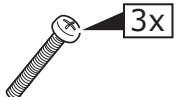
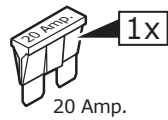
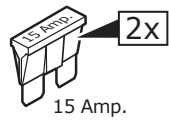
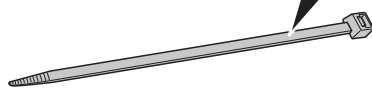

**INFO**

	BK	BN	BU	GY	GN	WH	YE	OG	PE	PI	RD
DE	Schwarz	Braun	Blau	Grau	Grün	Weiß	Gelb	Orange	Violett	Rosa	Rot
FR	Noir	Marron	Blue	Gris	Vert	Blanc	Jaune	Orange	Violet	Rose	Rouge
NL	Zwart	Bruin	Blauw	Grijs	Groen	Wit	Geel	Oranje	Paars	Roze	Rood
GB	Black	Brown	Blue	Grey	Green	White	Yellow	Orange	Purple	Pink	Red
ES	Negro	Marrón	Azul	Gris	Verde	Blanco	Amarillo	Naranja	Morado	Rosa	Rojo
IT	Nero	Marrone	Blu	Grigio	Verde	Bianco	Giallo	Arancione	Viola	Rosa	Rosso
SE	Svart	Brun	Blå	Grå	Grön	Vit	Gul	Orange	Lila	Rosa	Röd
CZ	Černá	Hnědá	Modrá	Šedá	Zelená	Bílá	Žlutá	Oranžová	Fialová	Růžová	Červená
DK	Sort	Brun	Blå	Grå	Grøn	Hvid	Gul	Orange	Lilla	Pink	Rød
FI	Musta	Ruskea	Sininen	Harmaa	Vihreä	Valkoinen	Keltainen	Oranssi	Purppura	Vaaleanpunainen	Punainen
GR	Μαύρο	Καφέ	Μπλε	Γκρι	Πράσινο	Λευκό	Κίτρινο	Πορτοκαλί	Μοβ	Ροζ	Κόκκινο
NO	Svart	Brun	Blå	Grå	Grønn	Hvit	Gul	Oransje	Lilla	Rosa	Rød
PL	Czarny	Brązowy	Niebieski	Szary	Zielony	Biały	Żółty	Pomarańczowy	Purpurowy	Różowy	Czerwony

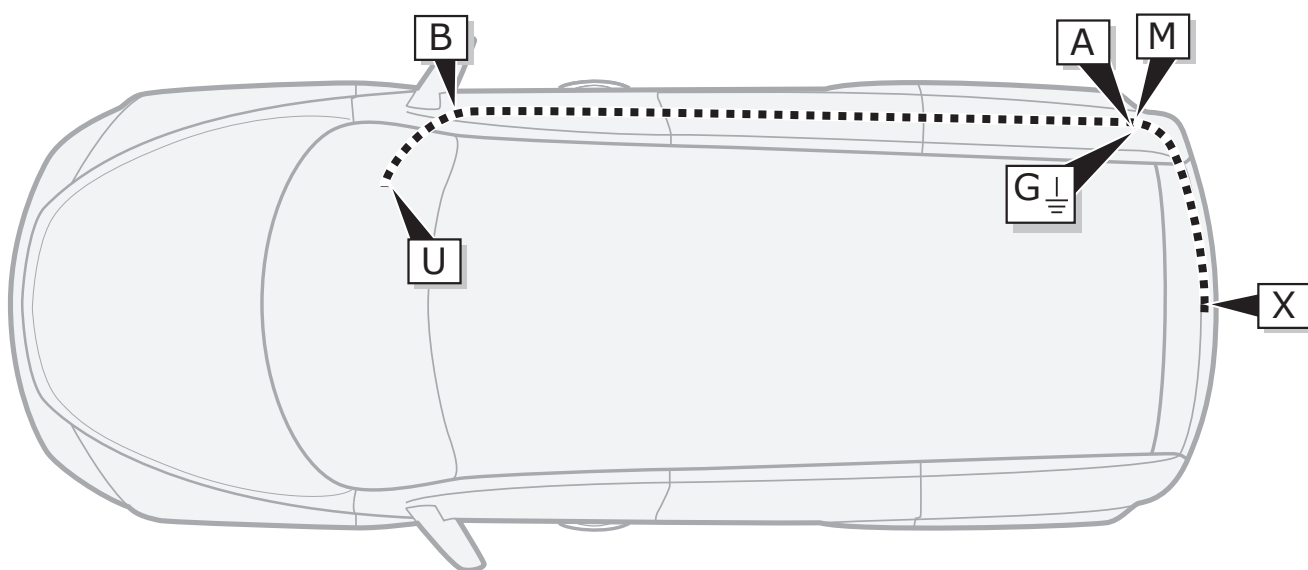
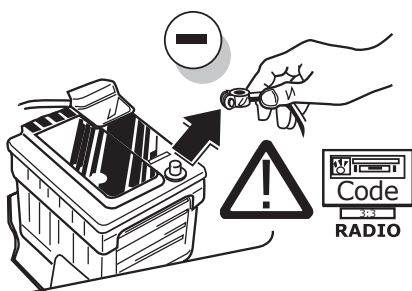
**ROUTING**

**1**

**DE** Um Störungen und Schäden am Bordnetz zu vermeiden, muss die Massepolklemme unbedingt vor Beginn aller Arbeiten von der Fahrzeugbatterie getrennt werden! Insbesondere bei Arbeiten und Anschlüssen am CAN-Datenbus kann bei nicht abgeklemmter Batterie sowohl das Anhängermodul als auch das fahrzeugseitige Bordnetzsteuergerät beschädigt werden! Bitte Herstellervorschriften beim Ab- und Anklemmen der Fahrzeugbatterie beachten!

**FR** Afin d'éviter tout dys-fonctionnement ou endom-magement du circuit de bord, il est indispensable de débrancher la pince de masse de la batterie du véhicule avant le début de toute opération! En particulier s'il s'agit de travaux et de branchements effectués sur le bus de données CAN, si la batterie n'est pas débranchée, le module remorque aussi bien que le dispositif de commande de circuit de bord du véhicule risquent d'être endommagés! Veuillez respecter les directives du fabricant lors du branchement et du débranchement de la batterie du véhicule!

**NL** Om storingen en schade aan de elektrische bedrading te vermijden moet de massapoolklem absoluut vóór aanvang van alle werkzaamheden worden losgekoppeld van de voertuigaccu! Vooral bij werkzaamheden aan en aansluitingen op de CAN-databus kan zowel de aanhangermodule als de voertuigzijdige regelenheid voor de elektrische installatie beschadigd worden, als de accu niet ontkoppeld is! Fabrieksvoorschriften bij het vast- en loskoppelen van de voertuigaccu in acht nemen a.u.b.!

**GB** In order to avoid mal-functions and damage to the vehicle's electrical system the earth terminal must be disconnected from the vehicle's battery before starting work! Both the trailer module and the vehicle's control unit for the electrical system can be damaged during work on the CAN data bus connections if the battery is not disconnected! Please pay attention to the manufacturer's instructions when disconnecting and reconnecting the vehicle's battery!

**ES** ¡Para evitar fallos y defectos en el sistema eléctrico de a bordo es imprescindible separar al terminal de puesta a tierra de la batería del vehículo antes de realizar cualquier trabajo! ¡Particularmente al realizar trabajos y conexiones al bus de datos CAN puede estropearse tanto el módulo para remolques como el regulador del sistema eléctrico de a bordo del vehículo si no se ha desconectado la batería! ¡Rogamos observar las instrucciones del fabricante al conectar y desconectar la batería del vehículo!

**IT** Per evitare disturbi e danni alla rete di distribuzione elettrica, l'espansione polare a massa deve essere assolutamente scollegata dalla batteria del veicolo prima dell'inizio dei lavori! In particolare durante i lavori e gli allacciamenti al bus di dati CAN, se la batteria non è scollegata si possono danneggiare sia la centralina rimorchio, sia la centralina della rete di distribuzione elettrica del veicolo! Attenersi alle indicazioni del costruttore per scollegare e ricollegare la batteria del veicolo!

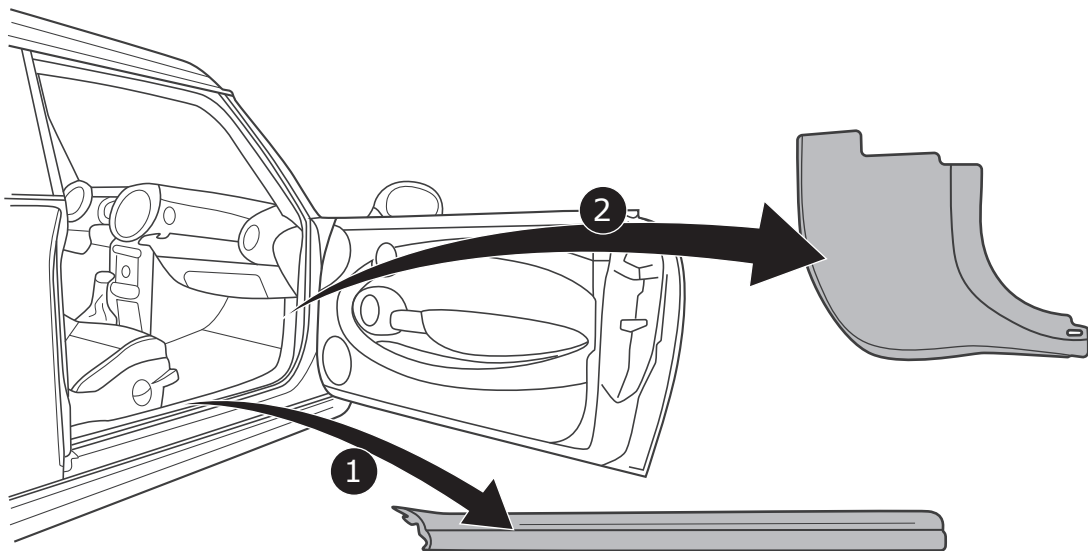
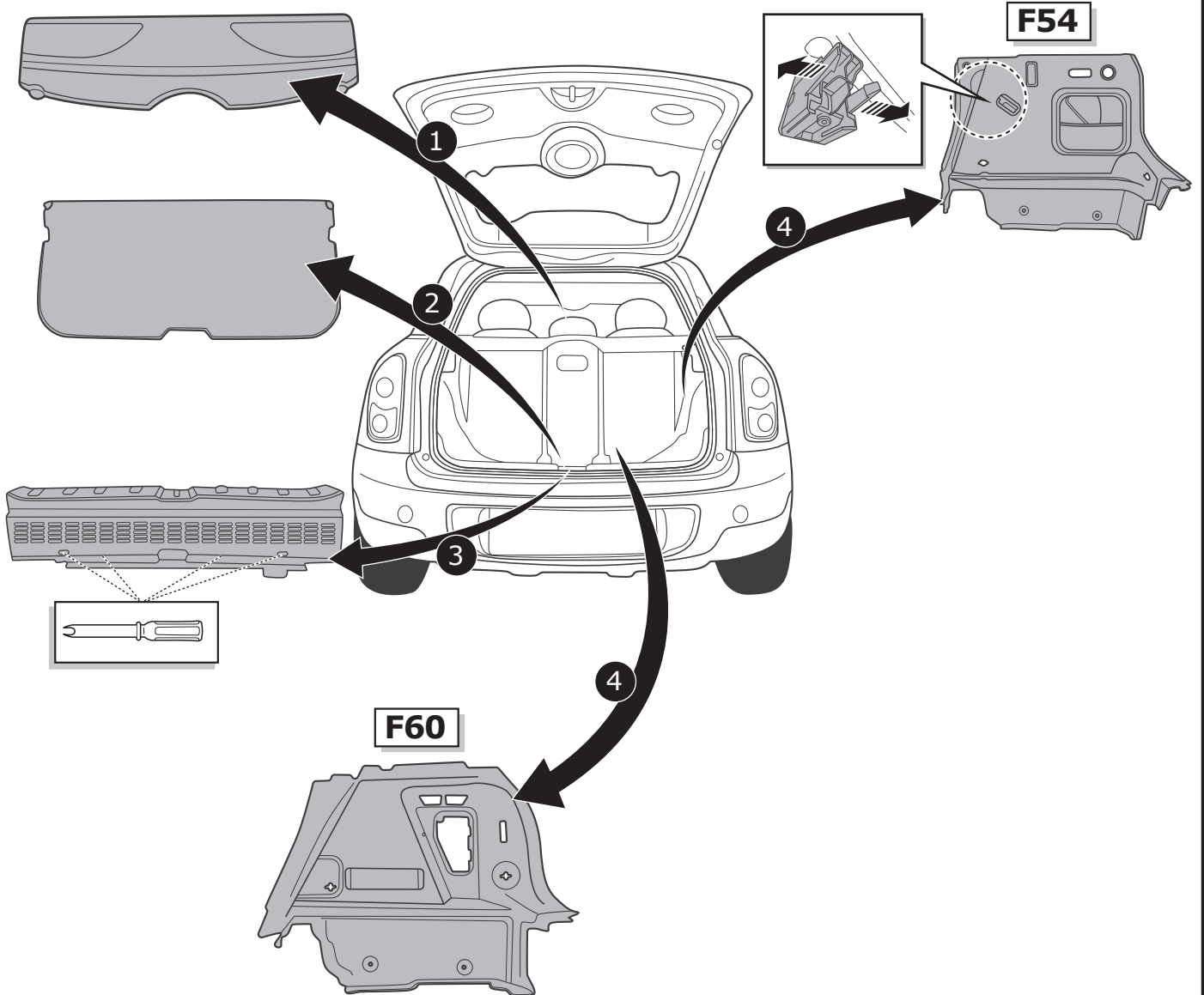

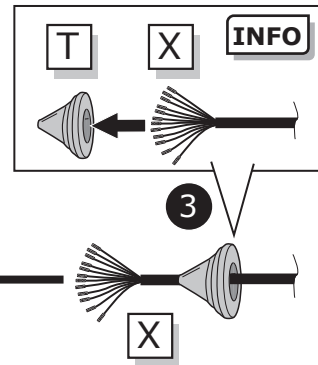
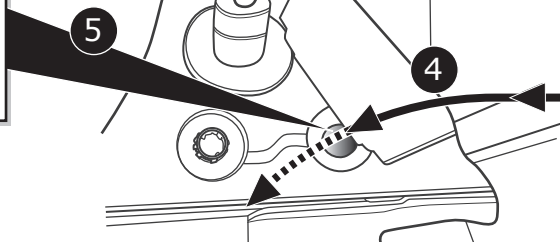
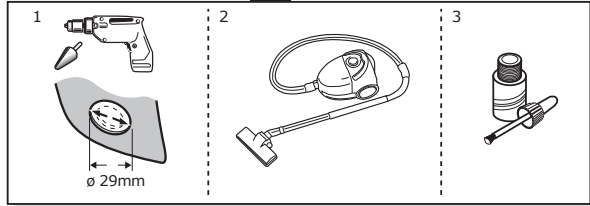
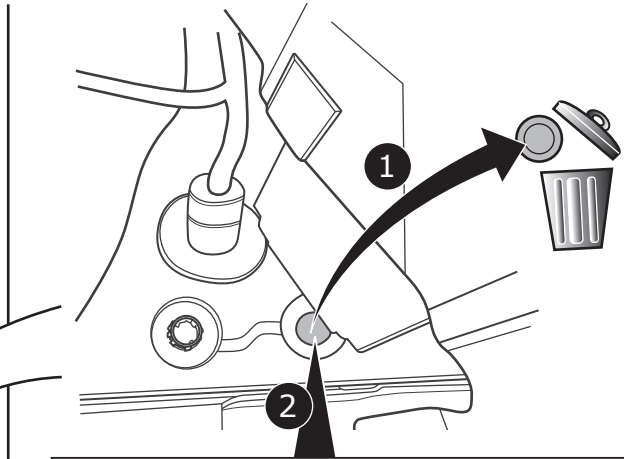
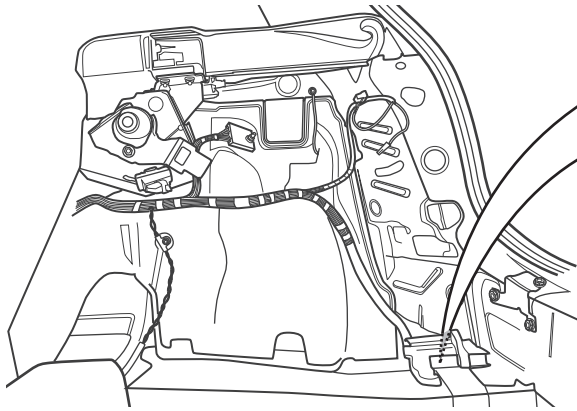
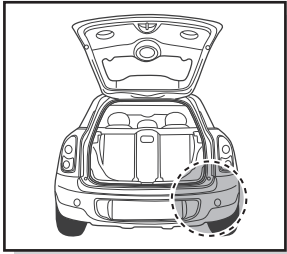

A

Option 1

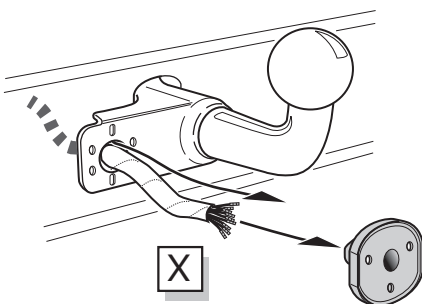

Option 2

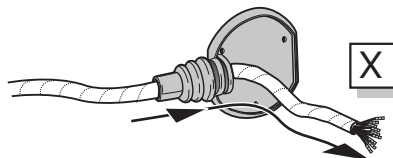

Option 3

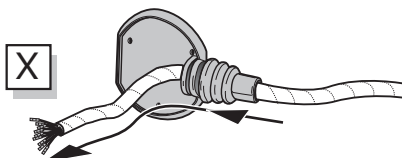

INFO

- (DE) Anschluss Steckdose
- (FR) Connection de la prise
- (NL) Contactdoos aansluiting
- (GB) Socket connection
- (ES) Conexión de la caja de enchufe
- (IT) Allaccio zoccolo
- (SE) Anslutning kontaktdosa
- (CZ) Objímkový konektor
- (DK) Stikdåse forbindelse
- (FI) Pistorasia liitäntä
- (GR) Υποδοχή σύνδεσης
- (NO) Tilkobling koblingsboks
- (PL) Połączenie przez gniazdo



**B**

Option 1

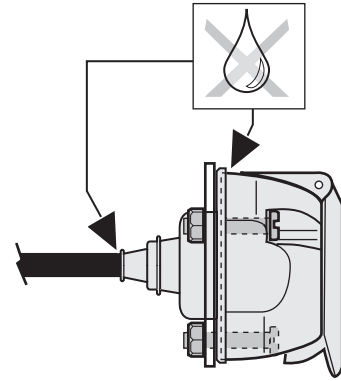
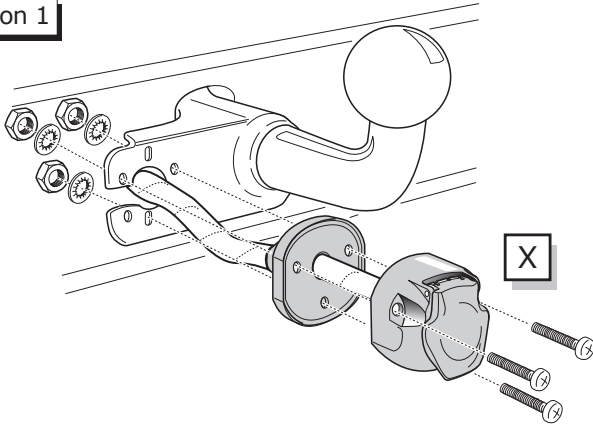
**C**

Option 2

1

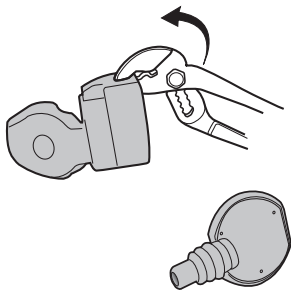

2

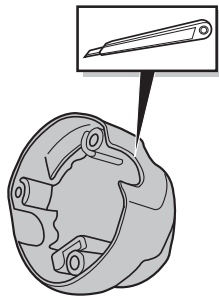

3

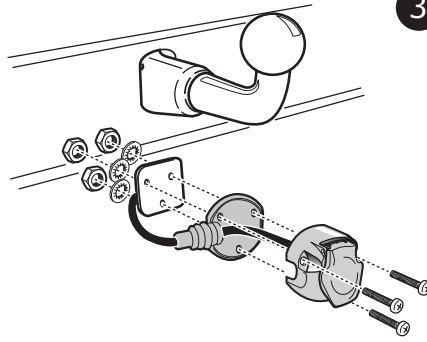

4

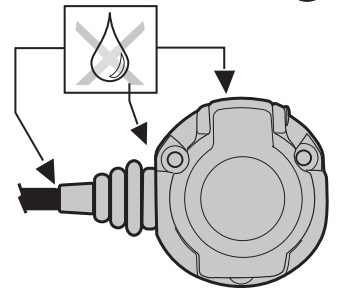
**D**

Option 3

1

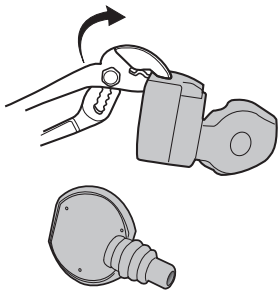

2

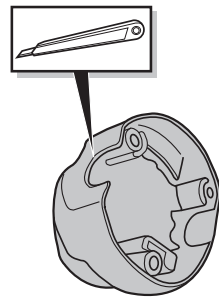

3

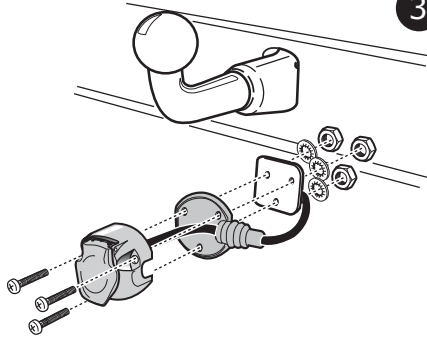

4

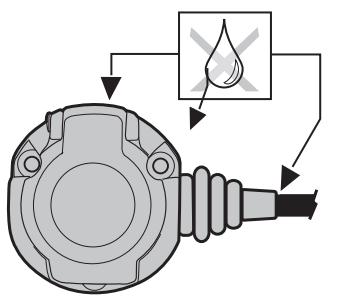
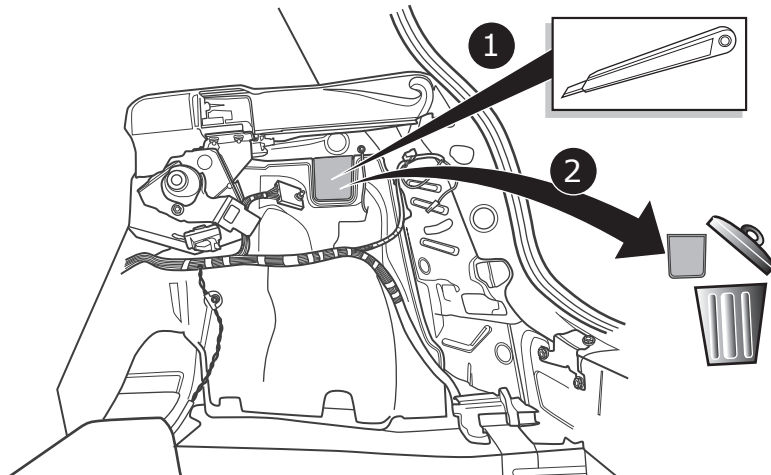
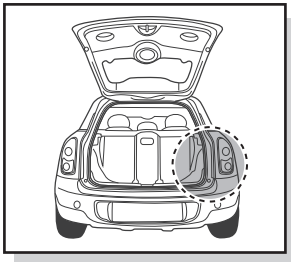
**5**

6

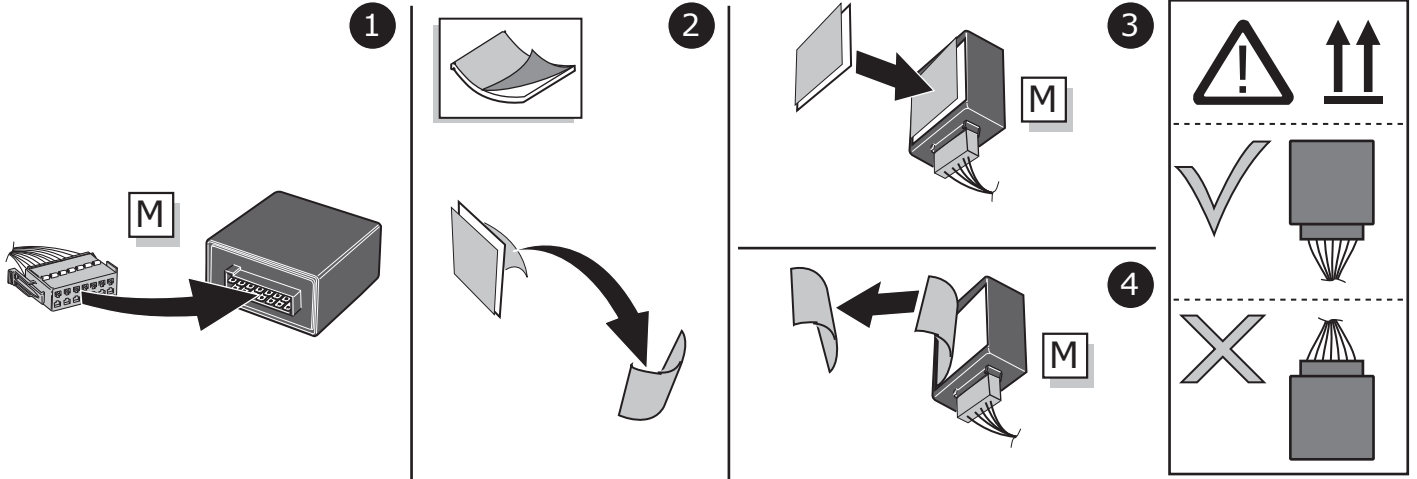

7

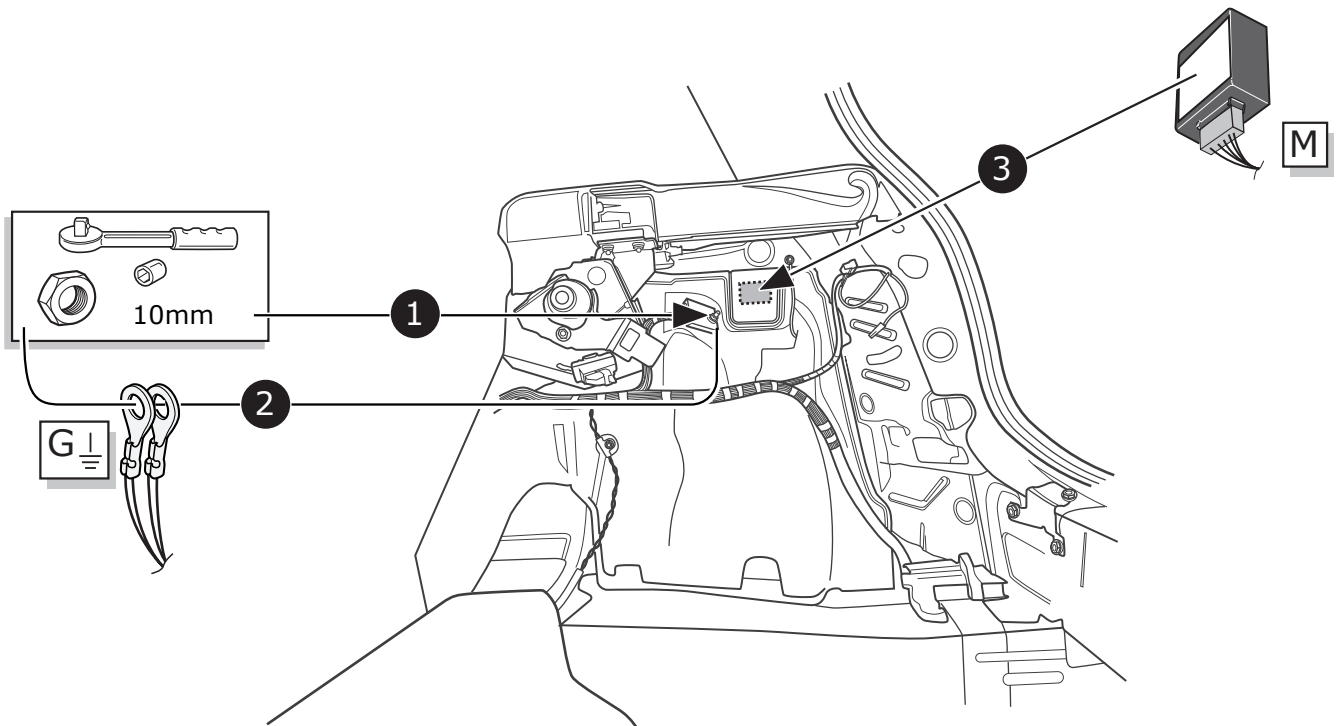
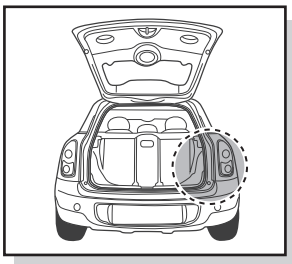

8

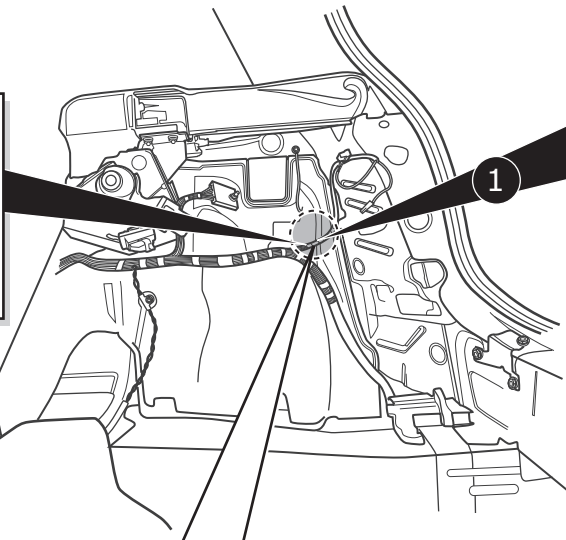
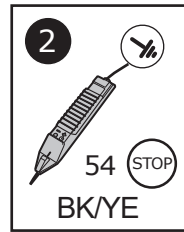
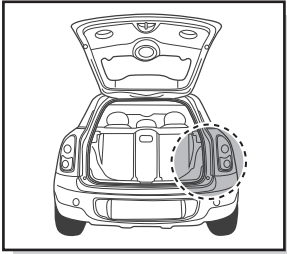

- Ⓛⓔ Klebeband entfernen.
- Ⓛⓔ Enlevez Ruban adhésif.
- Ⓛⓔ Tape verwijderen.
- Ⓛⓔ Remove tape.
- Ⓛⓔ Retirar la cinta adhesiva.
- Ⓛⓔ Rimuovere il nastro adesivo.
- Ⓛⓔ Avlāgsna klisterbandet.
- Ⓛⓔ Odstraňte pásku.
- Ⓛⓔ Aftag tapen.
- Ⓛⓔ Poista teippi.
- Ⓛⓔ Αφαιρέστε την ταινία.
- Ⓛⓔ Fjern limbåndet.
- Ⓛⓔ Zdjąć taśmę.

3

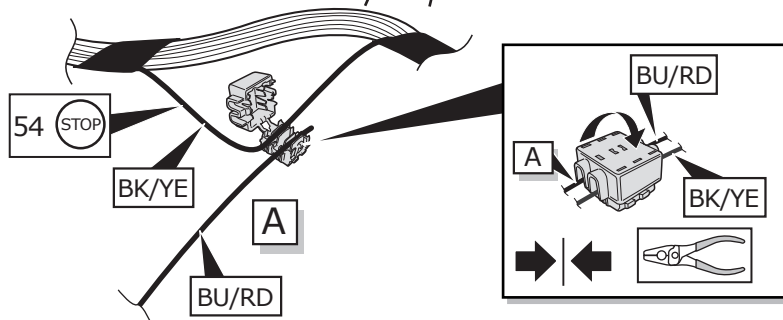

9

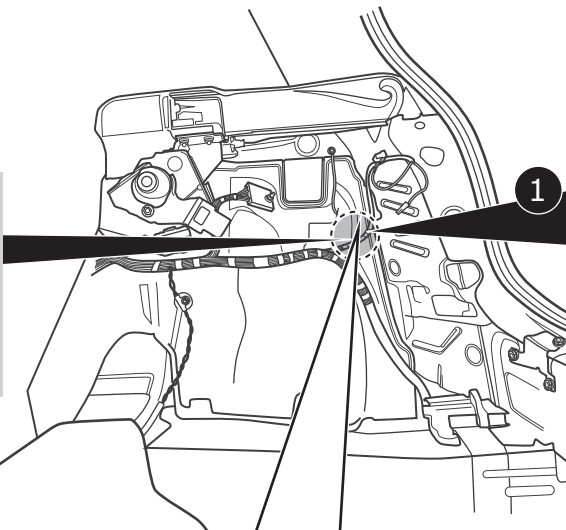
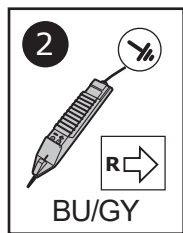
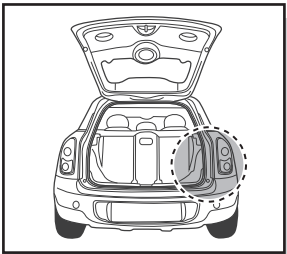

- Ⓛⓔ Klebeband entfernen.
- Ⓛⓔ Enlevez Ruban adhésif.
- Ⓛⓔ Tape verwijderen.
- Ⓛⓔ Remove tape.
- Ⓛⓔ Retirar la cinta adhesiva.
- Ⓛⓔ Rimuovere il nastro adesivo.
- Ⓛⓔ Avlāgsna klisterbandet.
- Ⓛⓔ Odstraňte pásku.
- Ⓛⓔ Aftag tapen.
- Ⓛⓔ Poista teippi.
- Ⓛⓔ Αφαιρέστε την ταινία.
- Ⓛⓔ Fjern limbåndet.
- Ⓛⓔ Zdjąć taśmę.

3

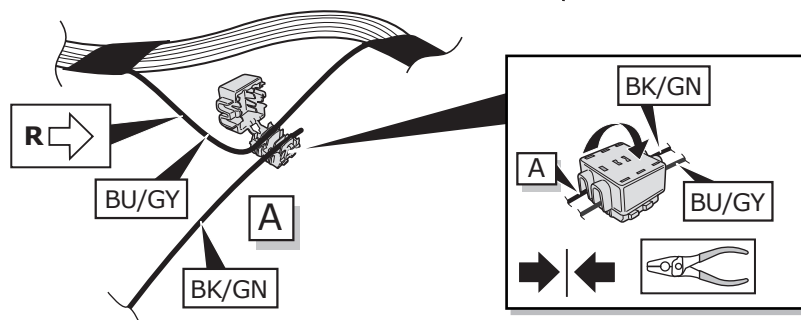



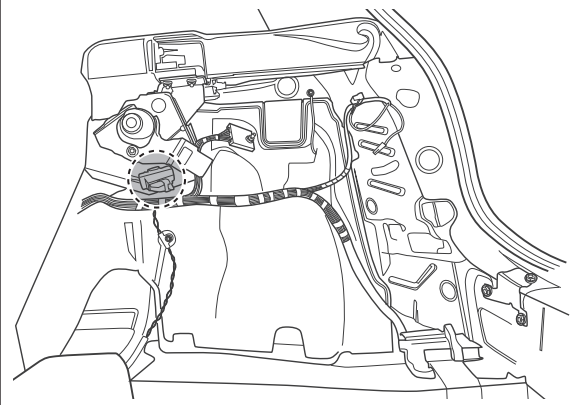

**CAN-Data Wire**  

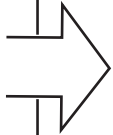

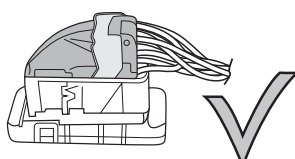
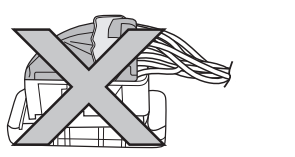
	<p><b>Option 1</b></p>
	<p><b>11 - 14</b></p>
	<p><b>23 - 40</b></p>
	<p><b>Option 2</b></p>
	<p><b>15 - 40</b></p>

**Option 1**

Cut to length!  
Auf gewünschte Länge zuschneiden!

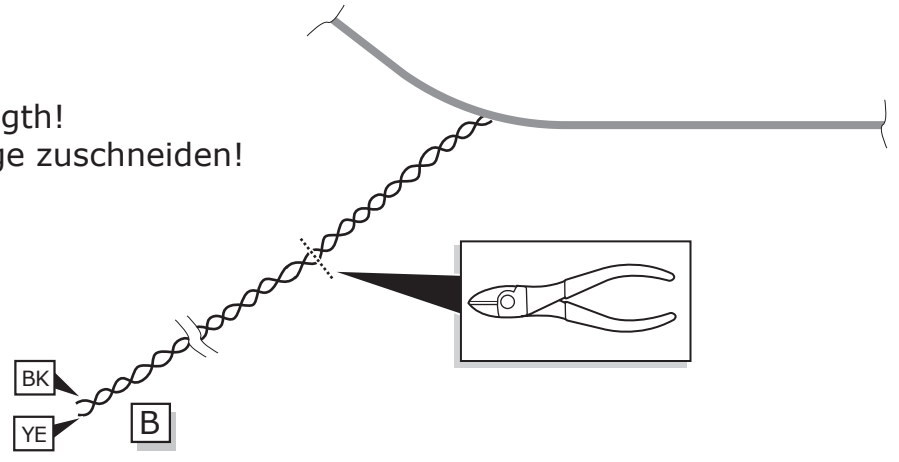

12

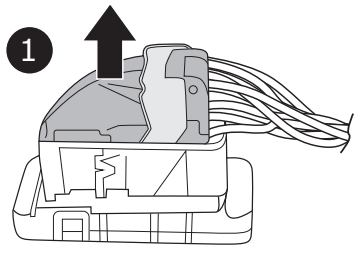
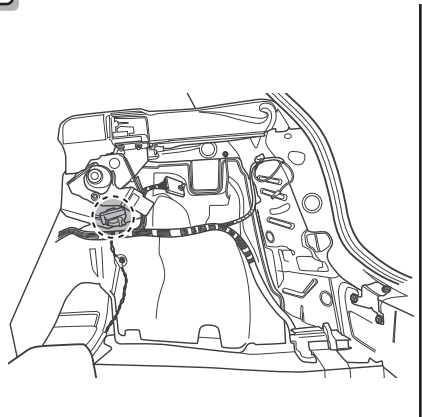

**CAN-Data Wire**  

 Important!  
Please note informations  
in picture 1!  
Wichtig!  
Unbedingt Hinweise  
aus Bild 1 beachten!



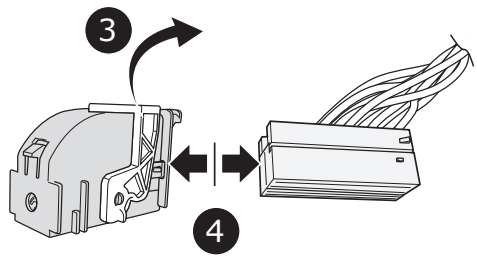
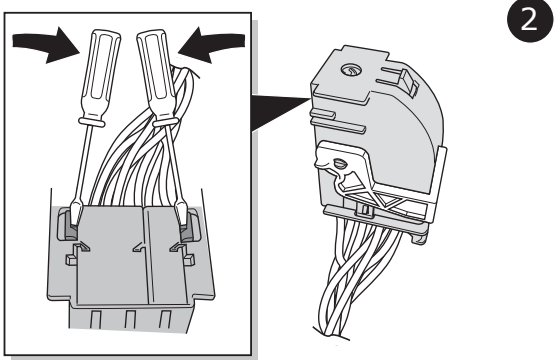

**Option 1**

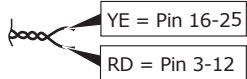

13

 Important!  
Please note informations  
in picture 1!  
Wichtig!  
Unbedingt Hinweise  
aus Bild 1 beachten!

**CAN-Data Wire**  

**Option 1**

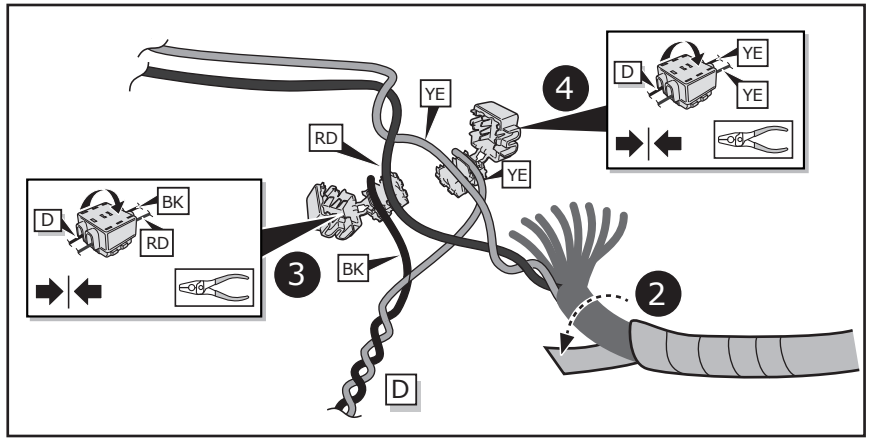
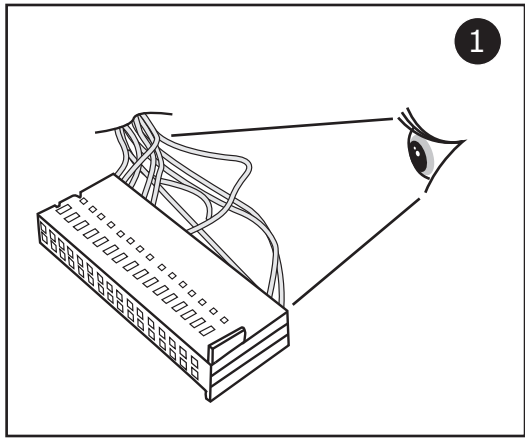

14

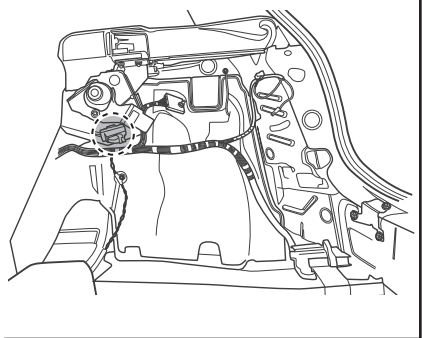

**Option 1**

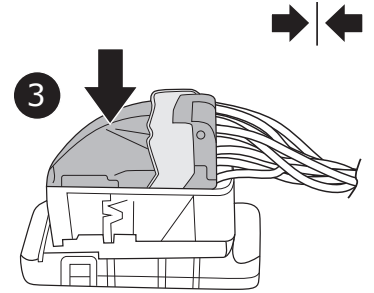
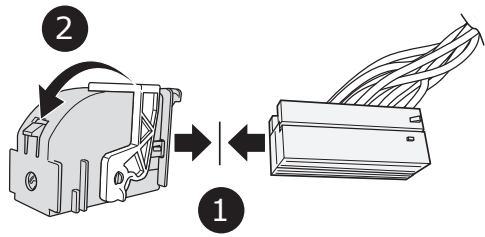

15

**Option 2**

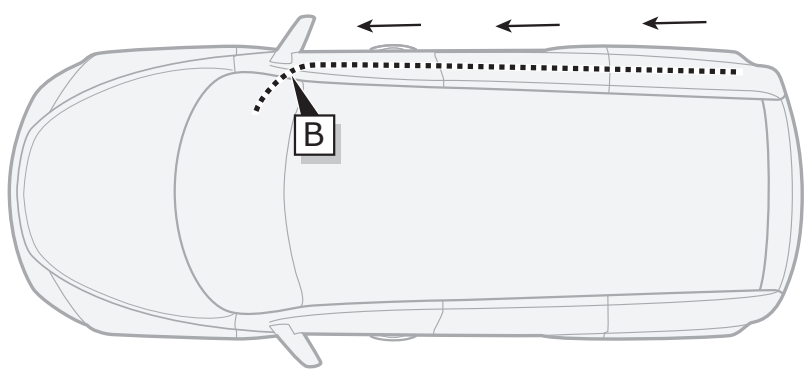

16

**Option 2a+2b**

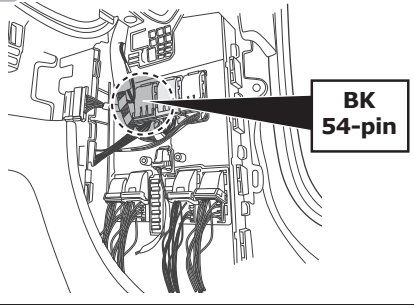

**BK 54-pin**

**!** Important!  
Please note informations  
in picture 1!  
Wichtig!  
Unbedingt Hinweise  
aus Bild 1 beachten!

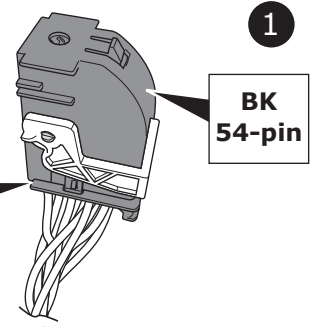
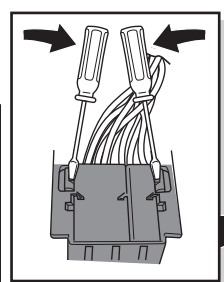

1

**BK 54-pin**

**CAN-Data Wire**

YE = Pos.49  
RD = Pos.50

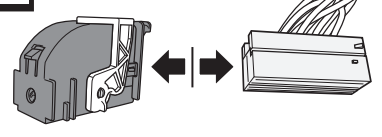

2

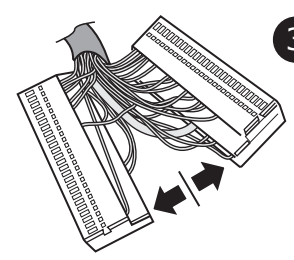

3

17

**Option 2a**

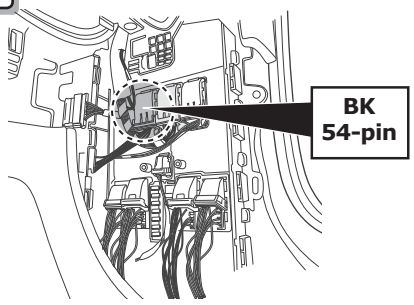

**BK 54-pin**

**!** Important!  
Please note informations  
in picture 1!  
Wichtig!  
Unbedingt Hinweise  
aus Bild 1 beachten!

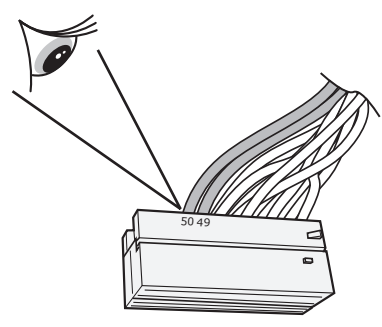

1

**CAN-Data Wire**

YE = Pos.49  
RD = Pos.50

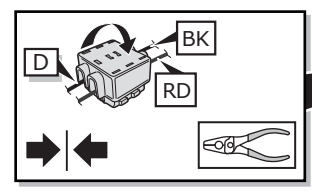

3

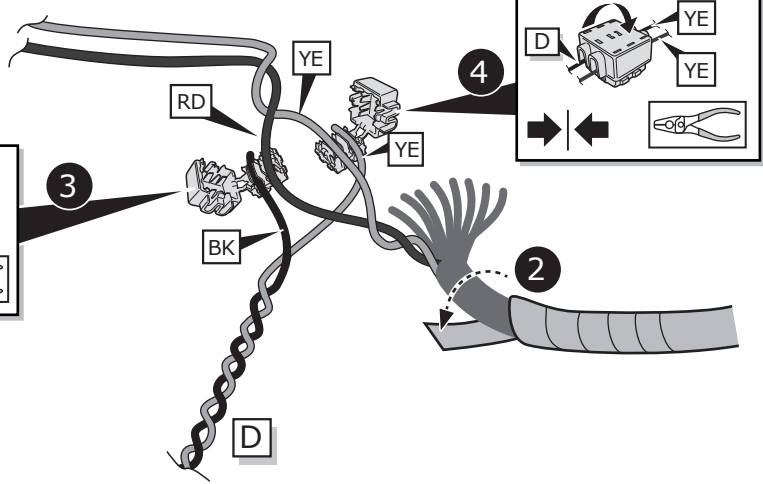

4

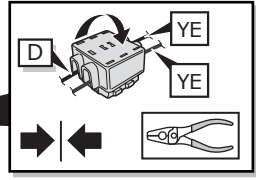

2

Option 2b

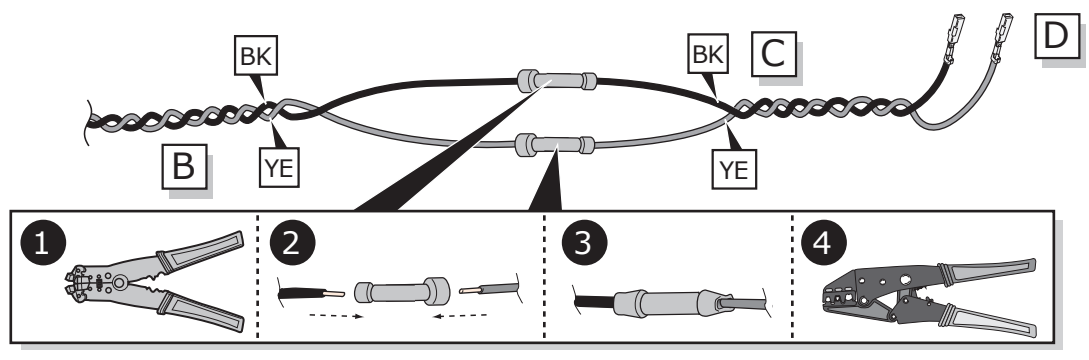

Option 2b

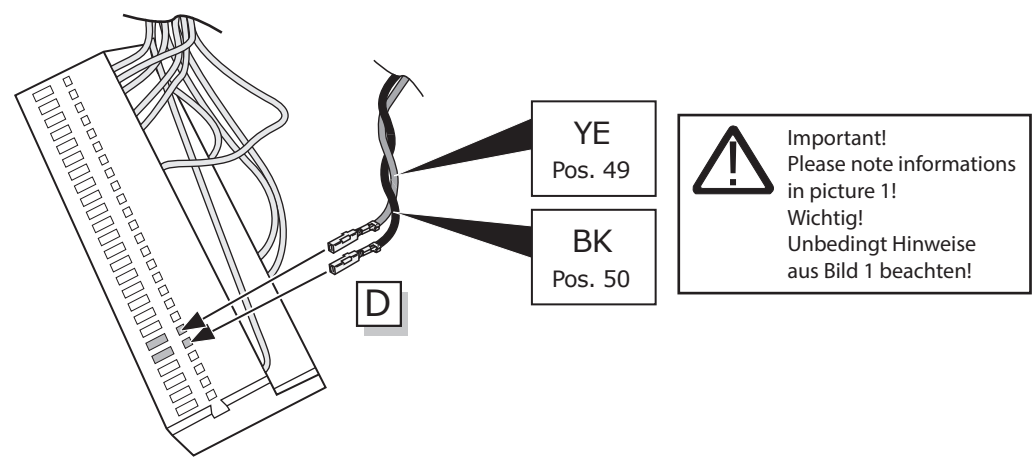

Option 2a+2b

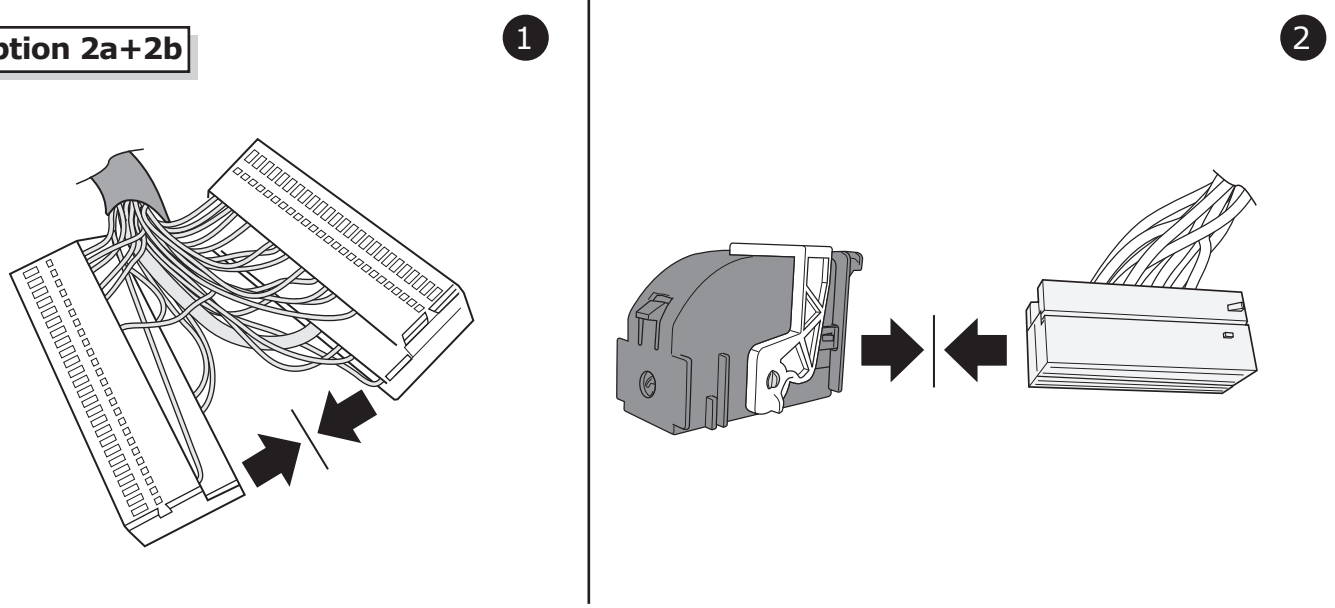

21

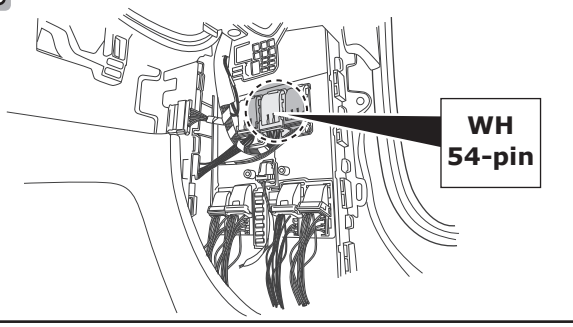

### Option 2c Low Spec Cars:

1

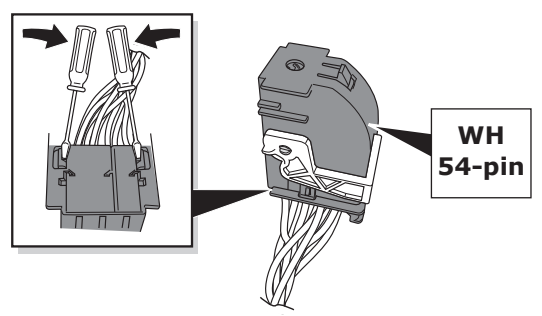

### CAN-Data Wire

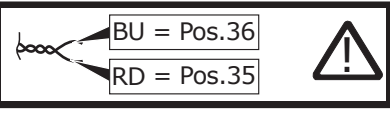

**Important!**  
Please note informations  
in picture 1!  
**Wichtig!**  
Unbedingt Hinweise  
aus Bild 1 beachten!

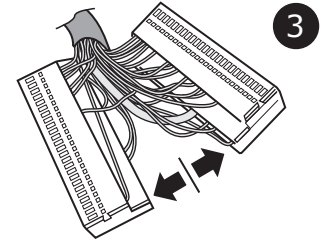
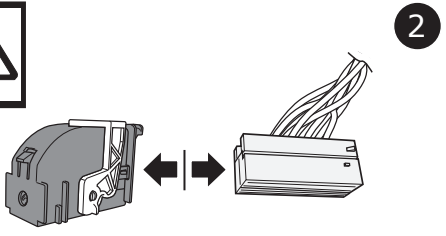

22

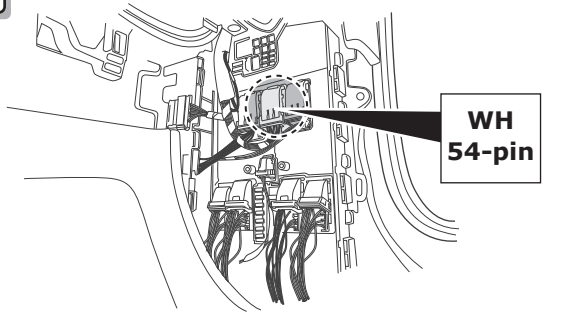

### Option 2c Low Spec Cars:

1

**Important!**  
Please note informations  
in picture 1!  
**Wichtig!**  
Unbedingt Hinweise  
aus Bild 1 beachten!

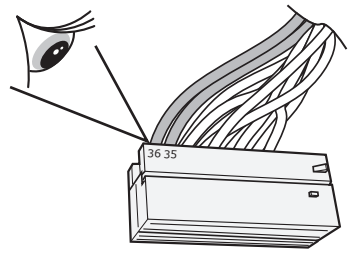

### CAN-Data Wire

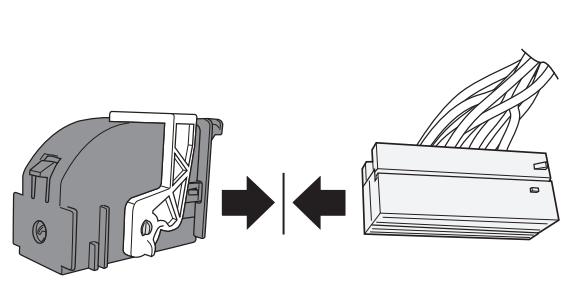
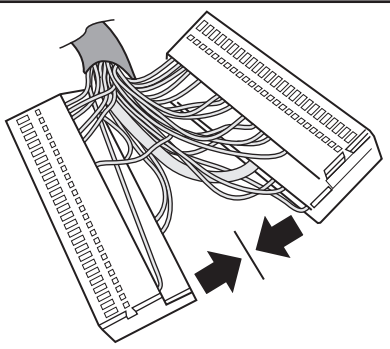
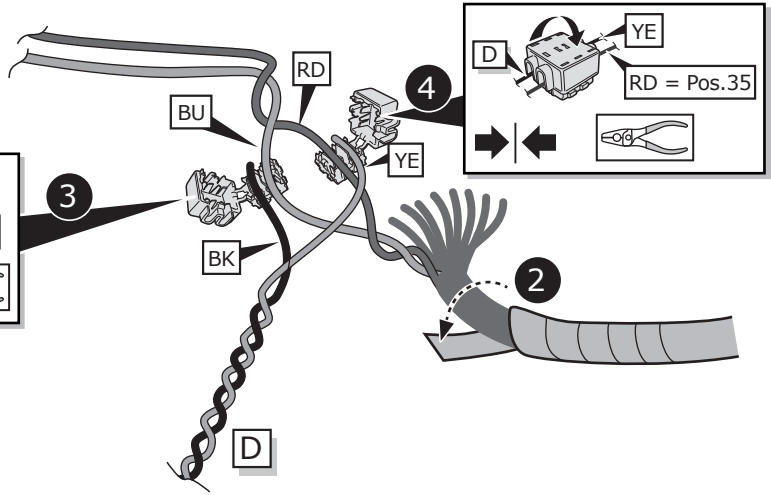
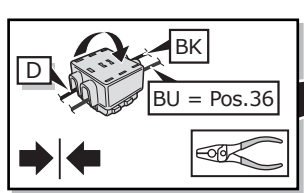
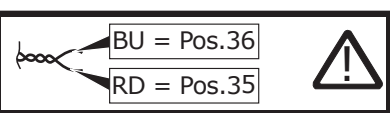

23

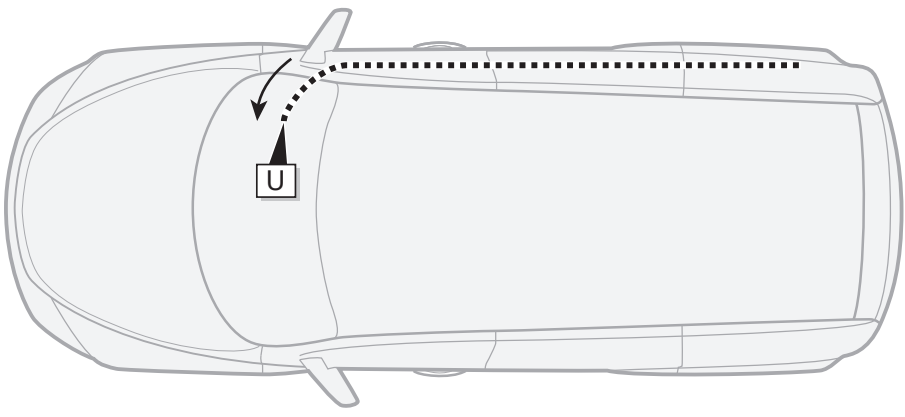

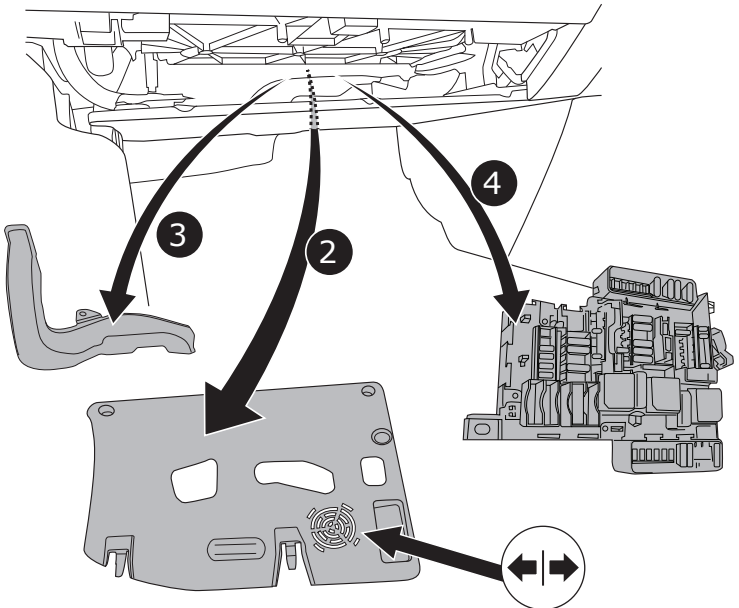
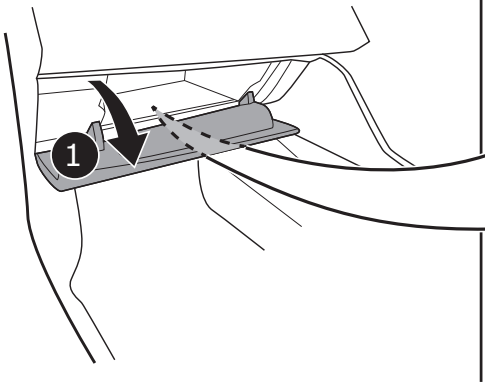
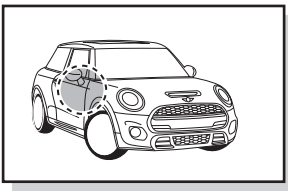

24

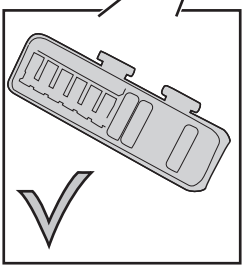
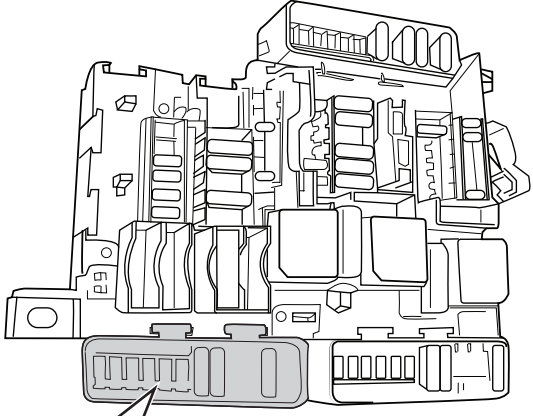

25

Option 1



 → **26 - 27**  
**31 - 40**

Option 2

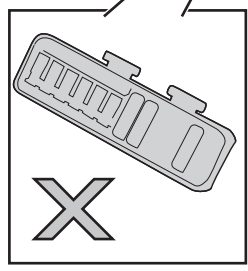
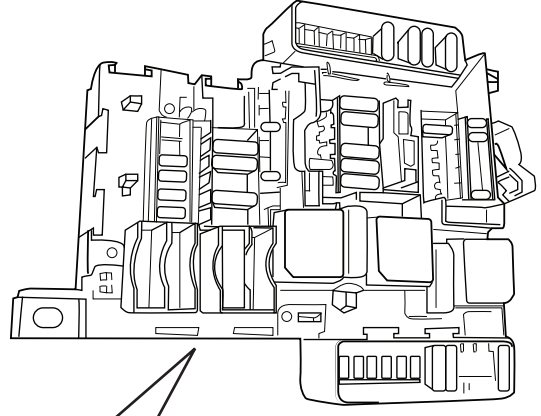

 → **28 - 40**

Option 1

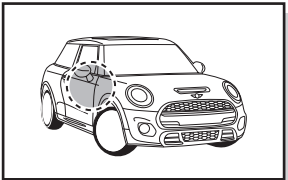

1

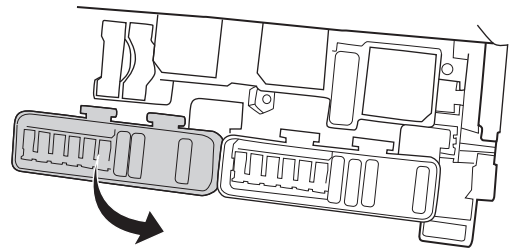

**RD/BU**  
Choose a free space  
Chamber 103-108  
Wählen Sie eine freie  
Kammer von 103-108

2

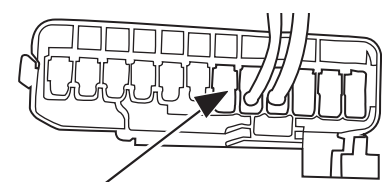

U

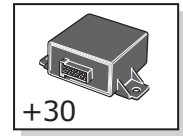

20 Amp.  
RD/BU

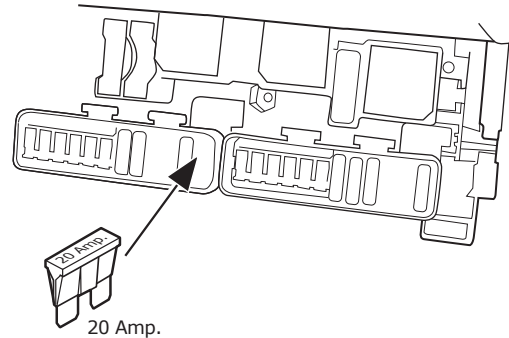

3

Option 1

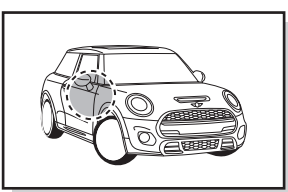

**Optional chamber 9**

1

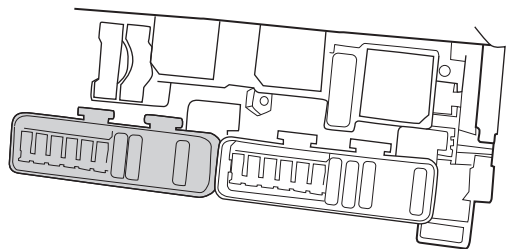

**OR**  
Choose a free space  
Chamber 103-108  
Wählen Sie eine freie  
Kammer von 103-108

2

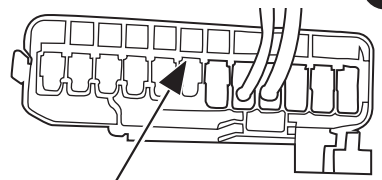

U

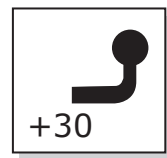

15 Amp.  
OG

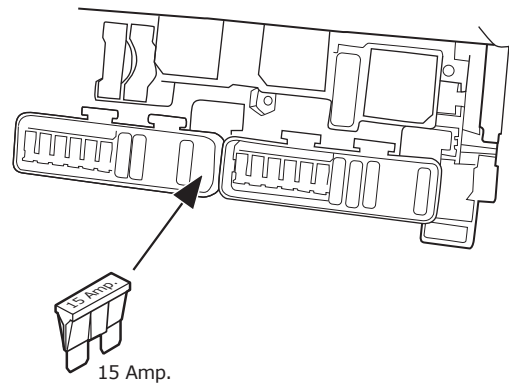

3

Option 2

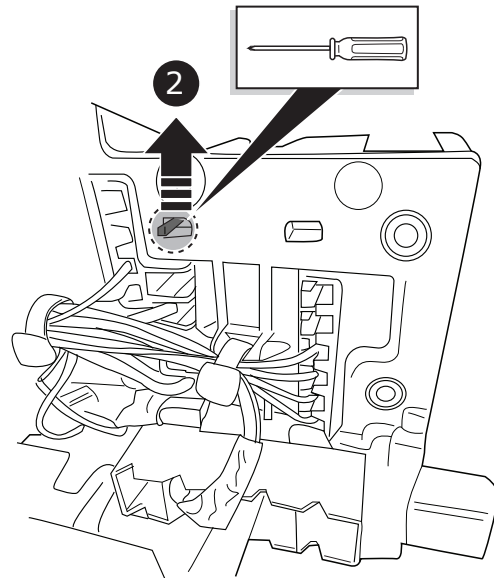
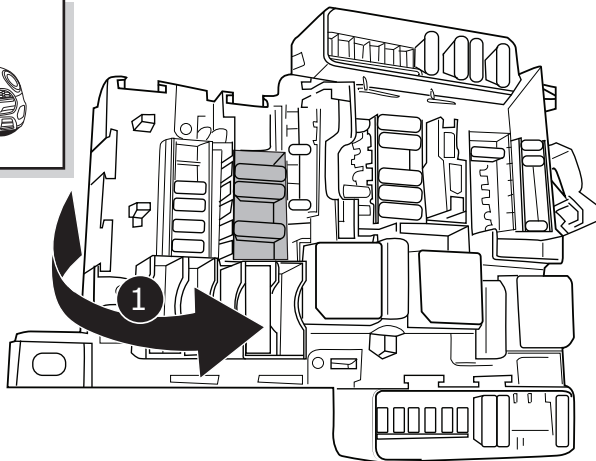
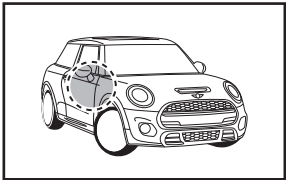

Option 2

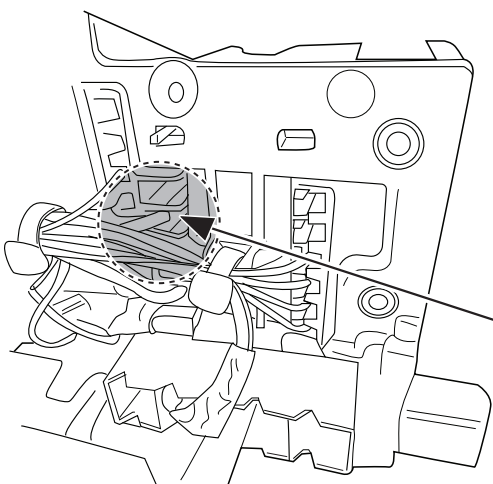
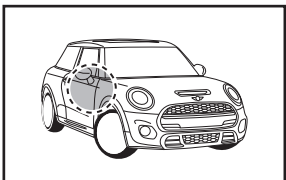

1

**RD/BU**  
Choose a free space  
Chamber 43-48  
Wählen Sie eine freie  
Kammer von 43-48

U

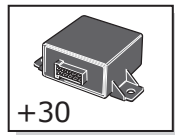

2

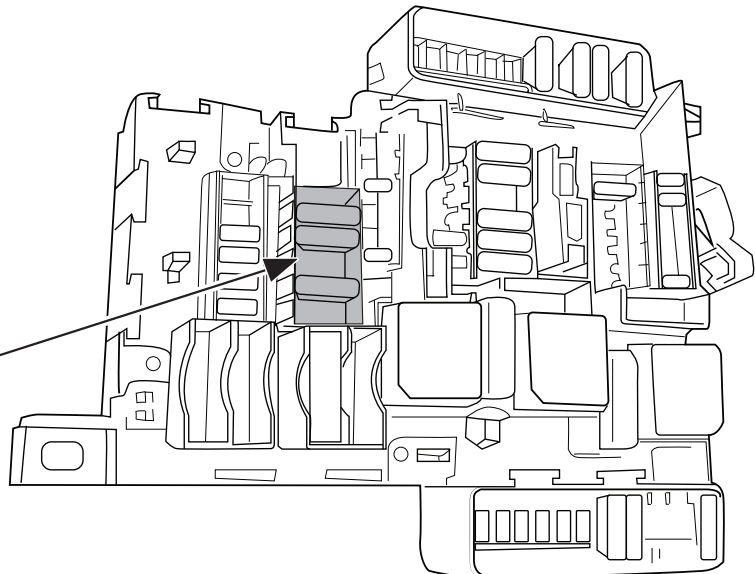
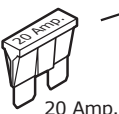
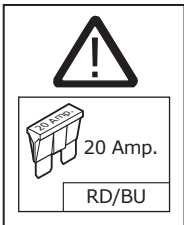



30

**Option 2**

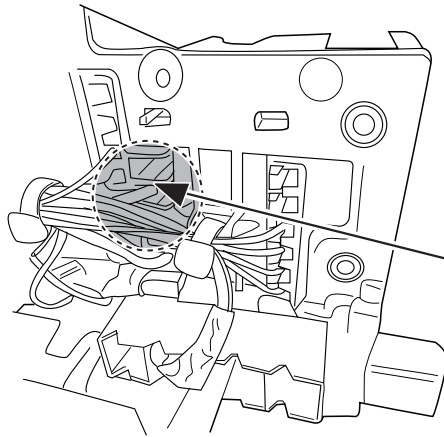
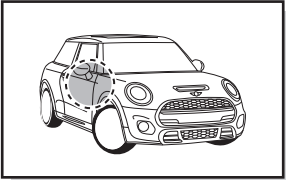

**OR**  
Choose a free space  
Chamber 43-48  
Wählen Sie eine freie  
Kammer von 43-48

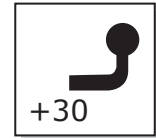

**Optional  
chamber 9**

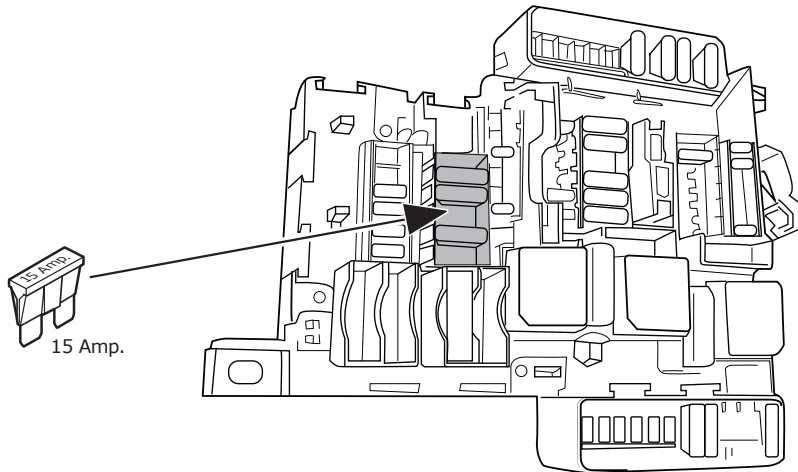
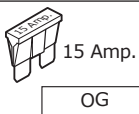

31

**Option 1 + 2**

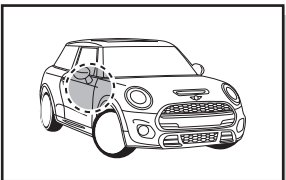

**Optional  
chamber 10**

1

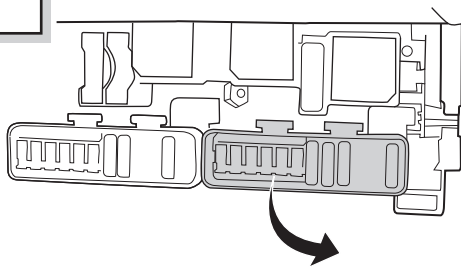

**GY**  
Choose a free space  
Chamber 127-132  
Wählen Sie eine freie  
Kammer von 127-132

2

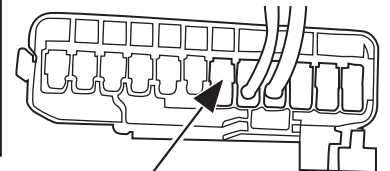

U

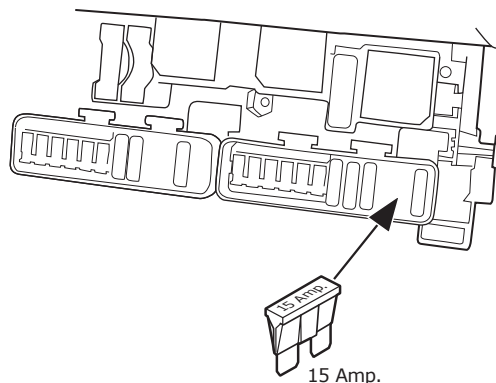
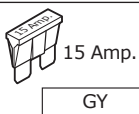
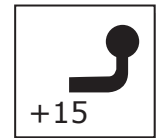

3

32

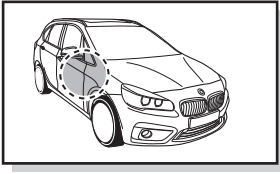

Please note the new fuse positions !!  
Bitte notieren Sie die neuen Sicherungspositionen !!

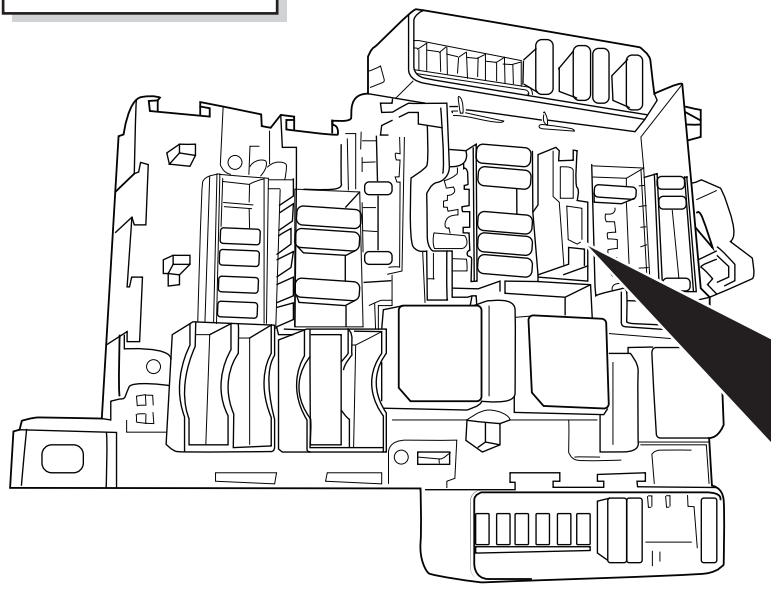

			Pos.: .....
			Pos.: .....
			Pos.: .....

33

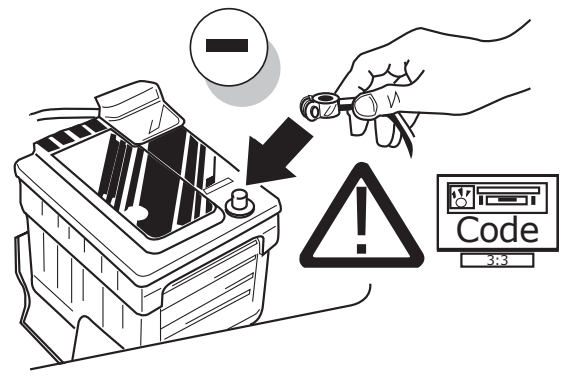

34

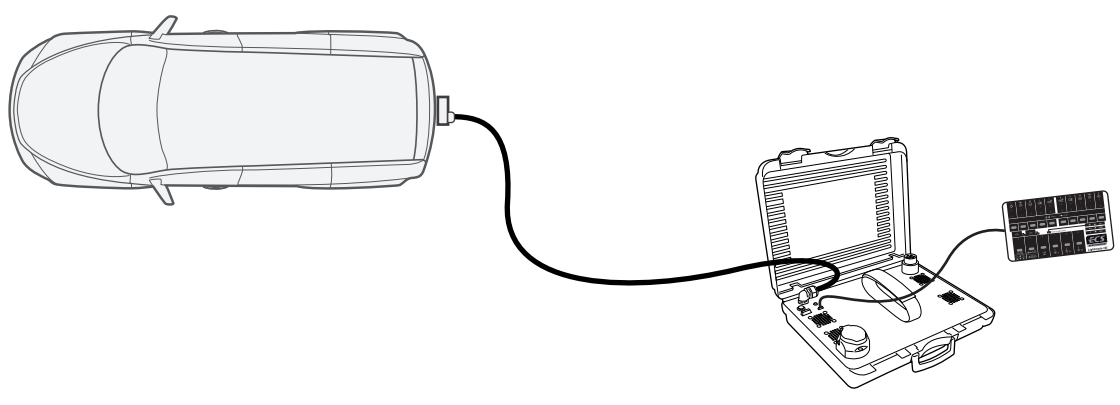

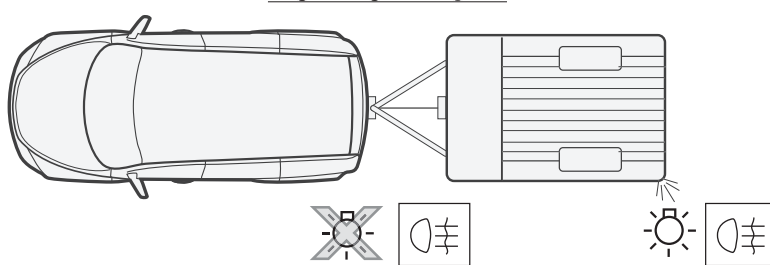
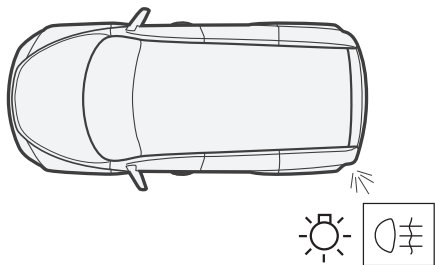
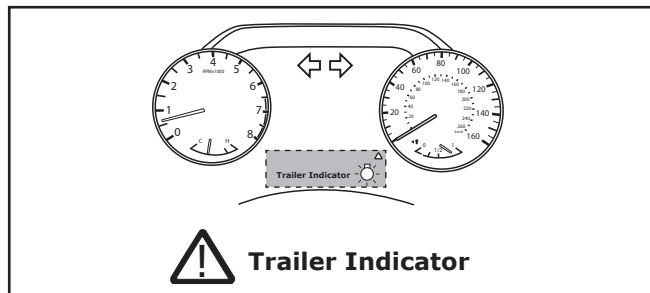
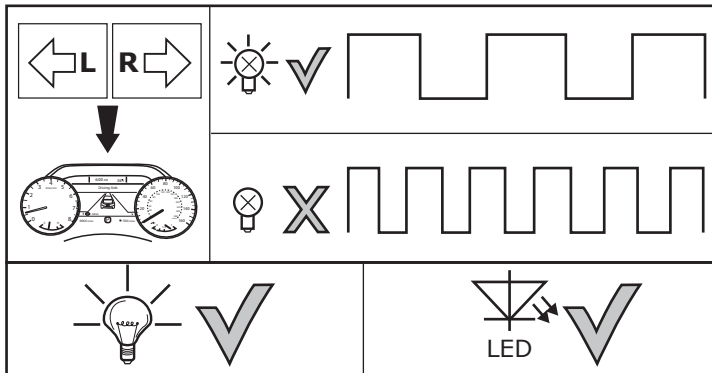
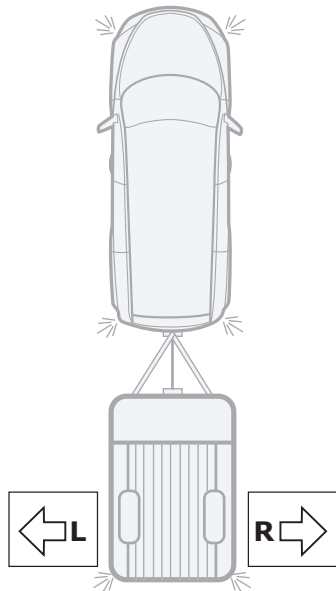
**Optional**

**Adapter socket**

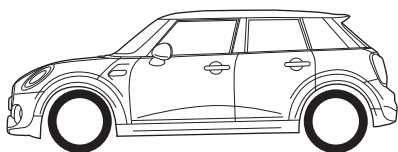

13-pin



7-pin



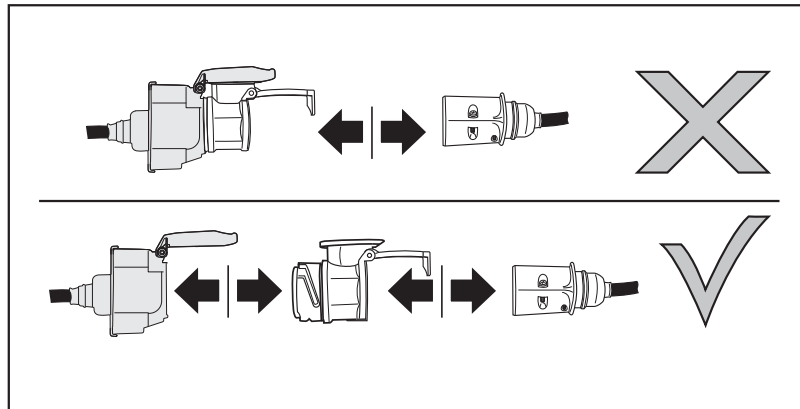
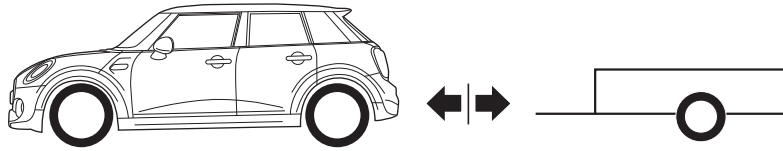

- |                                    |                                      |
|------------------------------------|--------------------------------------|
| (DE) Einzelteile wieder einbauen   | (CZ) Znovu zasuňte obložení          |
| (FR) Remonter les pièces démontées | (DK) Påsæt beklædningen              |
| (NL) Terug plaatsen onderdelen     | (FI) Asenna verhoilut takaisin       |
| (GB) Reinstall linings             | (GR) Τοποθετήστε ξανά τις επενδύσεις |
| (ES) Reinstalar componentes        | (NO) Sett tilbake deler              |
| (IT) Rimetti a posto componenti    | (PL) Założyć wykładzinę              |
| (SE) Sätt tillbaka delar           |                                      |

- |                               |
|-------------------------------|
| (DE) Einbauanleitung          |
| (FR) Instructions de montage  |
| (NL) Montage-handleiding      |
| (GB) Fitting instructions     |
| (ES) Instrucciones de montaje |
| (IT) Istruzioni di montaggio  |
| (SE) Monteringsanvisningar    |
| (CZ) Montážní pokyny          |
| (DK) Monteringsvejledninger   |
| (FI) Ohjeet asentamiseen      |
| (GR) Οδηγίες συναρμολόγησης   |
| (NO) Monteringsanviser        |
| (PL) Instrukcje montażu       |

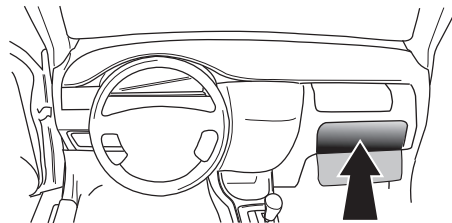

**TECHNICAL SUPPORT**

**CALL FREE**  
00800  
2255  
2327









**ECS ELECTRONICS** MONDAY TO FRIDAY  
08.00 - 12.00  
13.00 - 17.00  
ts@ecs-electronics.nl  
www.ecs-electronics.nl

(DE) Anschluss Steckdose  
 (FR) Connection de la prise  
 (NL) Contactdoos aansluiting  
 (GB) Socket connection

(ES) Conexión de la caja de enchufe  
 (IT) Allaccio zoccolo  
 (SE) Anslutning kontaktdosa

(CZ) Objímkový konektor  
 (DK) Stikdåse forbindelse  
 (FI) Pistorasia liitäntä

(GR) Υποδοχή σύνδεσης  
 (NO) Tilkobling koblingsboks  
 (PL) Połączenie przez gniazdo

DIN/ISO 11446												
1/L	2	3/31	4/R	5/58-R	6/54	7/58-L	8	9	10	11	12	13
Pmax	21W	21W	21W	42W	3x21W	42W	21W	180W/15Amp.	180W/15Amp.	180W/15Amp.	180W/15Amp.	180W/15Amp.
(DE)	Gelb	Weiß	Grün	Braun	Rot	Schwarz	Rosa	Orange	Grau	Weiß/ Schwarz	-	Weiß/ Rot
(FR)	Jaune	Blanc	Vert	Marron	Rouge	Noir	Rose	Orange	Gris	Blanc/ Noir	-	Blanc/ Rouge
(NL)	Geel	Wit	Groen	Bruin	Rood	Zwart	Roze	Oranje	Grijs	Wit/ Zwart	-	Wit/ Rood
(GB)	Yellow	White	Green	Brown	Red	Black	Pink	Orange	Grey	White/ Black	-	White/ Red
(ES)	Amarillo	Blanco	Verde	Marrón	Rojo	Negro	Rosa	Naranja	Gris	Blanco/ Negro	-	Blanco/ Rojo
(IT)	Giallo	Bianco	Verde	Marrone	Rosso	Nero	Rosa	Arancione	Grigio	Bianco/ Nero	-	Bianco/ Rosso
(SE)	Gul	Vit	Grön	Brun	Röd	Svart	Rosa	Orange	Grå	Vit/ Svart	-	Vit/ Röd
(CZ)	Žlutá	Bílá	Zelená	Hnědá	Červená	Černá	Růžová	Oranžová	Šedá	Bílá/ Černá	-	Bílá/ Červená
(DK)	Gul	Hvid	Grøn	Brun	Rød	Sort	Pink	Orange	Grå	Hvid/ Sort	-	Hvid/ Rød
(FI)	Keltainen	Valkoinen	Vihreä	Ruskea	Punainen	Musta	Vaaleanpunainen	Oranssi	Hamaa	Valkoinen/ Musta	-	Valkoinen/ Punainen
(GR)	Κίτρινο	Λευκό	Πράσινο	Καφέ	Κόκκινο	Μαύρο	Ροζ	Πορτοκαλί	Γκρι	Λευκό/ Μαύρο	-	Λευκό/ Κόκκινο
(NO)	Gul	Hvit	Grønn	Brun	Rød	Svart	Rosa	Oransje	Grå	Hvit/ Svart	-	Hvit/ Rød
(PL)	Żółty	Biały	Zielony	Brązowy	Czerwony	Czarny	Różowy	Pomarańczowy	Szary	Biały/ Czarny	-	Biały/ Czerwony