

No. 21500670

VW

Einbauanleitung

Elektro-Einbausatz für Anhängerkupplung 13-polig / 12 Volt / ISO 11446

Fitting instructions

Electric wiring kit for towbars 13-pin / 12 Volt / ISO 11446

Instructions de montage

Faisceau pour attelage 13 broches / 12 Volt / ISO 11446

Istruzione di montaggio

Cablaggio elettrico per ganci di traino 13 poli / 12 Volt / ISO 11446

Instrucciones de montaje

Kits eléctricos para enganches de remolques 13 pins / 12 Volt / ISO 11446

Montagehandleiding

Elektro-inbouwset voor aanhangerkoppeling 13-polig / 12 Volt / ISO 11446

Instrukcja montażu

Zestaw elektryczny do haka holowniczego / 13-biegunowy / 12 Volt / ISO 11446

Návod na použitie

Elektrosada pre ťažné zariadenie / 13-pol / 12 Volt / ISO 11446

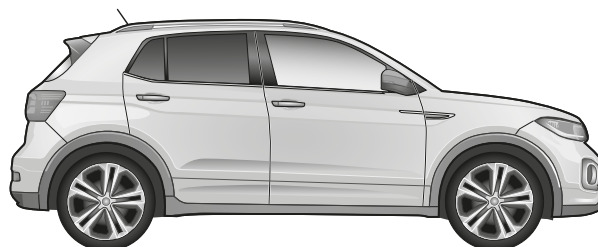
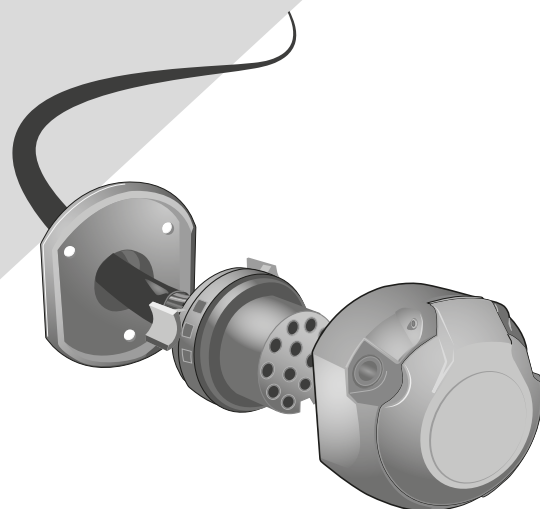

T-Cross (C1)

04/19 →

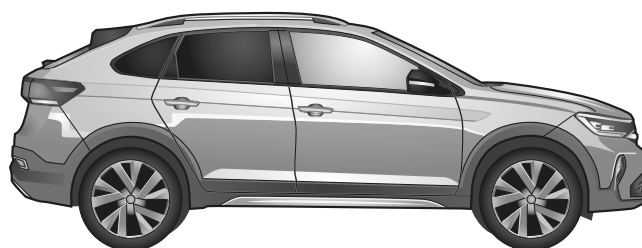

Taigo (CS)

11/21→

WICHTIG!



D Der Einbau dieses Elektrosatzes muss von einer Fachwerkstatt oder entsprechend qualifizierten Person durchgeführt werden. Vorsichtsmaßnahmen und Richtlinien vom Fahrzeughersteller müssen beachtet werden. Vor Beginn aller Montagearbeiten unbedingt die Einbauanleitung komplett durchlesen. Nach Einbau des Elektrosatzes ist die Einbauanleitung den Serviceunterlagen des Fahrzeugs beizulegen!

Bei unsachgemäßer Anwendung oder Veränderung des Elektrosatzes bzw. der darin befindlichen Bauteile erlischt jeder Anspruch auf Gewährleistung. Beim Fahren ohne Anhänger oder Ladungsträger müssen ggf. verwendete Adapter immer aus der Steckdose entfernt werden. Änderungen bezüglich Konstruktion, Ausstattung, Farbe sowie Irrtum vorbehalten. Alle Angaben und Abbildungen unverbindlich.

Für technische bzw. elektronische Änderungen, sowie Softwareupdates, welche nach erstmaliger Inbetriebnahme des Elektrosatzes vom Fahrzeughersteller durchgeführt werden und beispielsweise zu Fehlfunktionen der Anhängersteckdose oder deren Peripherie führen, übernehmen wir keinerlei Gewährleistung! Das Anhängermodul ist nicht diagnosefähig!

IMPORTANT!



GB This electric kit has to be installed by a professional workshop or a suitably qualified person. The installation instructions must have been read completely before the start of any installation. Precautions and guidelines from the vehicle manufacturer must be observed. Following installation of the electric kit, the installation instructions must be kept together with the vehicle's service documents!

All warranty claims will be forfeited if the electric kit or components contained therein are used incorrectly or modified. When driving without a trailer or load carrier, any adapters that have been used must always be unplugged from the socket. Subject to changes with respect to design, equipment, colour and error. All of the data and illustrations are without obligation.

We can assume no warranty or guarantee for technical and electrical modifications or software updates carried out by the vehicle manufacturer following the initial commissioning of the electric kit and which, for example, may lead to malfunctions in the trailer socket or its peripheral equipment! The trailer module has not a diagnostic capability!

IMPORTANT!



F Le montage de ce kit de connexion électrique doit être effectué par un atelier spécialisé ou une personne possédant la qualification correspondante. Avant de débiter toute opération de montage, il est indispensable d'avoir lu entièrement les consignes de montage! Les précautions et directives du constructeur du véhicule doivent être respectées. Une fois le kit de connexion électrique monté, joindre impérativement les consignes de montage aux documents de service du véhicule!

Toute utilisation ou modification inappropriée du kit de connexion électrique ou des pièces se trouvant à l'intérieur de celui-ci fait perdre toute prétention à une garantie. Pour la conduite sans remorque ni support de chargement, il faudra toujours au préalable retirer de la prise l'adaptateur utilisé le cas échéant. Sous réserve de modifications sur le plan de la construction, de l'équipement, de la couleur ainsi que d'erreurs. Toutes les informations et illustrations sont fournies sans engagement.

Nous déclinons toute responsabilité pour les modifications techniques ou électroniques, ainsi que pour les mises à jour logicielles réalisées après la mise en service initiale du kit électronique du constructeur du véhicule et pouvant provoquer par exemple des dysfonctionnements de la prise de courant de la remorque ou de sa périphérie! Le module de remorque n'a pas de capacité de diagnostic!

IMPORTANTE!



I Il montaggio di questo gruppo elettronico deve essere effettuato esclusivamente da un'officina specializzata o da personale debitamente qualificato. Prima dell'inizio di tutti i lavori di montaggio, accertarsi di avere letto le istruzioni di montaggio complete. È necessario osservare le precauzioni e le linee guida del produttore del veicolo. Dopo avere effettuato il montaggio del gruppo elettronico, la documentazione di montaggio deve essere assolutamente allegata alla documentazione di assistenza del veicolo!

In caso di utilizzo scorretto o modifica del gruppo elettronico o dei componenti ivi contenuti, decade ogni diritto di garanzia! Se si viaggia senza rimorchio o piattaforma di carico, gli adattatori eventualmente utilizzati devono essere sempre scollegati dalla presa. Con riserva di modifiche strutturali, di dotazione, colore ed errori. Tutti i dati e le figure non sono vincolanti.

Non concediamo alcuna garanzia per modifiche tecniche o elettroniche, aggiornamenti software che dopo la prima messa in funzione del gruppo elettronico vengono effettuate dal costruttore del veicolo e, ad esempio, possono causare malfunzionamenti della presa del rimorchio o delle sue periferiche! Il modulo trailer non ha una capacità diagnostica!

¡IMPORTANTE!



ES El montaje de este kit eléctrico se debe llevar a cabo en un taller especializado o por parte de una persona correspondientemente cualificada. ¡Antes de comenzar cualquier trabajo de montaje se deben haber leído las instrucciones de montaje por completo! Se deben observar las precauciones y pautas del fabricante del vehículo. ¡Después de haber montado el kit eléctrico es obligatorio adjuntar las instrucciones de montaje a los documentos de servicio del vehículo!

El uso indebido o la modificación del kit eléctrico o de los componentes en su interior supone la extinción de cualquier derecho de garantía. Si se usa el vehículo sin remolque o plataforma de carga, siempre se deberán separar los adaptadores utilizados del enchufe. Queda reservado el derecho a realizar modificaciones constructivas, de equipamiento y color y de posibles errores. Todos los datos e ilustraciones se entienden sin compromiso.

¡No asumiremos garantía alguna por modificaciones técnicas y/o electrónicas o actualizaciones de software que se lleven a cabo después de la primera puesta en servicio del kit eléctrico por parte del fabricante del vehículo y que puedan dar lugar, por ejemplo, a fallos de funcionamiento de la base eléctrica para el remolque o los periféricos! ¡El módulo de remolque no tiene capacidad de diagnóstico!

BELANGRIJK!



NL De montage van deze elektrische set moet worden verricht door een bevoegde garage of een daarmee vergelijkbaar gekwalificeerd persoon. Voorafgaand aan elke montage moet men de gebruiksaanwijzing volledig hebben gelezen! Voorzorgsmaatregelen en richtlijnen van de voertuigfabrikant moeten in acht worden genomen. Na de montage van de elektrische set is het absoluut noodzakelijk dat u de gebruiksaanwijzing bewaart bij de gegevens van de servicebeurt van uw voertuig!

In geval van ondeskundig gebruik en/of wijziging van de elektrische set en/of de daartoe behorende onderdelen vervalt elke garantie. Zodra u zonder aanhangert of ladingdrager rijdt, moet u de desbetreffende adapters altijd loskoppelen van de stekkerdoos. Wijzigingen voorbehouden ten aanzien van constructie, uitrusting, kleur en/of eventuele misrekening/verginging. Aan deze informatie en afbeeldingen kunnen geen rechten worden ontleend.

Wij dragen geen enkele aansprakelijkheid voor technische en/of elektronische wijzigingen alsmede software-updates die worden verricht na de eerste inbedrijfstelling van de elektrische set door de autofabrikant en die bijvoorbeeld leiden tot fouten in het functioneren van de aanhangerstekkerdoos en/of de randapparatuur! De trailer module heeft geen diagnostische mogelijkheid!

WAŻNE!



PL Zestaw elektryczny musi być zainstalowany przez profesjonalny warsztat lub odpowiednio wykwalifikowaną osobę. Instrukcje instalacji muszą zostać przeczytane i w pełni zrozumiane przed rozpoczęciem jakiegokolwiek instalacji. Należy przestrzegać środków ostrożności i wytycznych producenta pojazdu. Po instalacji zestawu elektrycznego instrukcje montażu należy przechowywać razem z dokumentacją serwisową pojazdu!

Wszelkie roszczenia gwarancyjne ulegają przypadkowi, jeśli zestaw lub komponenty elektryczne w nim zawarte są używane nieprawidłowo lub zmodyfikowane. Podczas jazdy bez przyczepy lub bagażnika rowerowego, wszelkie zastosowane adaptery muszą zawsze być odłączone od gniazdka. Zastrzegamy sobie zmiany w zakresie projektu, wyposażenia, koloru i błędów. Wszystkie dane i ilustracje nie są w 100% wiążące. Tekst w języku angielskim niniejszej instrukcji instalacji jest wiążący!

Nie możemy przyjąć żadnej odpowiedzialności ani gwarancji na techniczne i elektryczne modyfikacje lub aktualizacje oprogramowania przeprowadzone przez producenta pojazdu po pierwszym uruchomieniu zestawu elektrycznego, które może na przykład prowadzić do nieprawidłowego działania w gnieździe elektrycznym haka holowniczego. Moduł przyczepy nie ma możliwości diagnostycznych!

DÔLEŽITÉ!



SK Montáž tejto elektrosady musí byť vykonaná v špecializovanom servise alebo kvalifikovanou osobou. Pred začatím akýchkoľvek inštalčných prác je nevyhnutné dôkladne prečítať si tento návod a inštalčné pokyny v ňom uvedené musia byť úplne pochopené! Musia sa dodržiavať bezpečnostné opatrenia a pokyny výrobcu vozidla. Po inštalácii elektrosady musí byť montážny návod uložený k servisným dokumentom vozidla!

Nesprávne používanie alebo úprava elektrosady alebo jej komponentov vedie k zániku akéhokoľvek nároku na záruku. Pri jazde bez prívessu alebo nosiča nákladu musia byť použité adaptéry vždy odpojené zo zásuvky. Zmeny týkajúce sa konštrukcie, vybavenia, farieb, ako aj omyly sú vyhradené. Všetky informácie a obrázky sú nezáväzné.

Za technické alebo elektrické modifikácie a aktualizácie softvéru, ktoré sa vykonajú výrobcom vozidla po úvodnom uvedení elektrosady do prevádzky a môžu viesť napríklad k poruche zásuvky prívessu alebo jej periférnym zariadení, neposkytujeme žiadnu záruku! Modul prívessu nemá diagnostické schopnosti!

IMPORTANT!

Check before connecting! ⚠

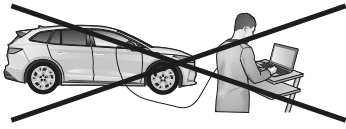

Vehicles with UNECE
PR code: NI1, NI7, NI8 and NI9
cannot be coded at the current status!

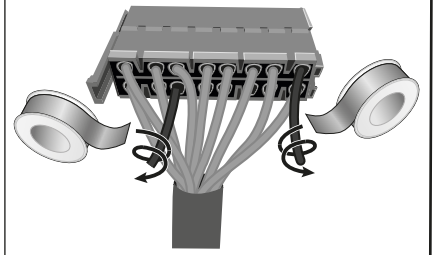
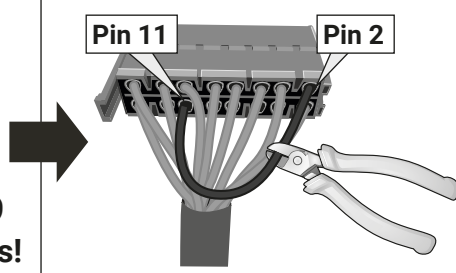

Pin-out Tool

Driver assist systems
not supported in
cruiser mode.

15A 20A

2x 3x 2x 2x

3x

3x

15x 5x

25-35

12-16

4-10, 17-20

Taigo

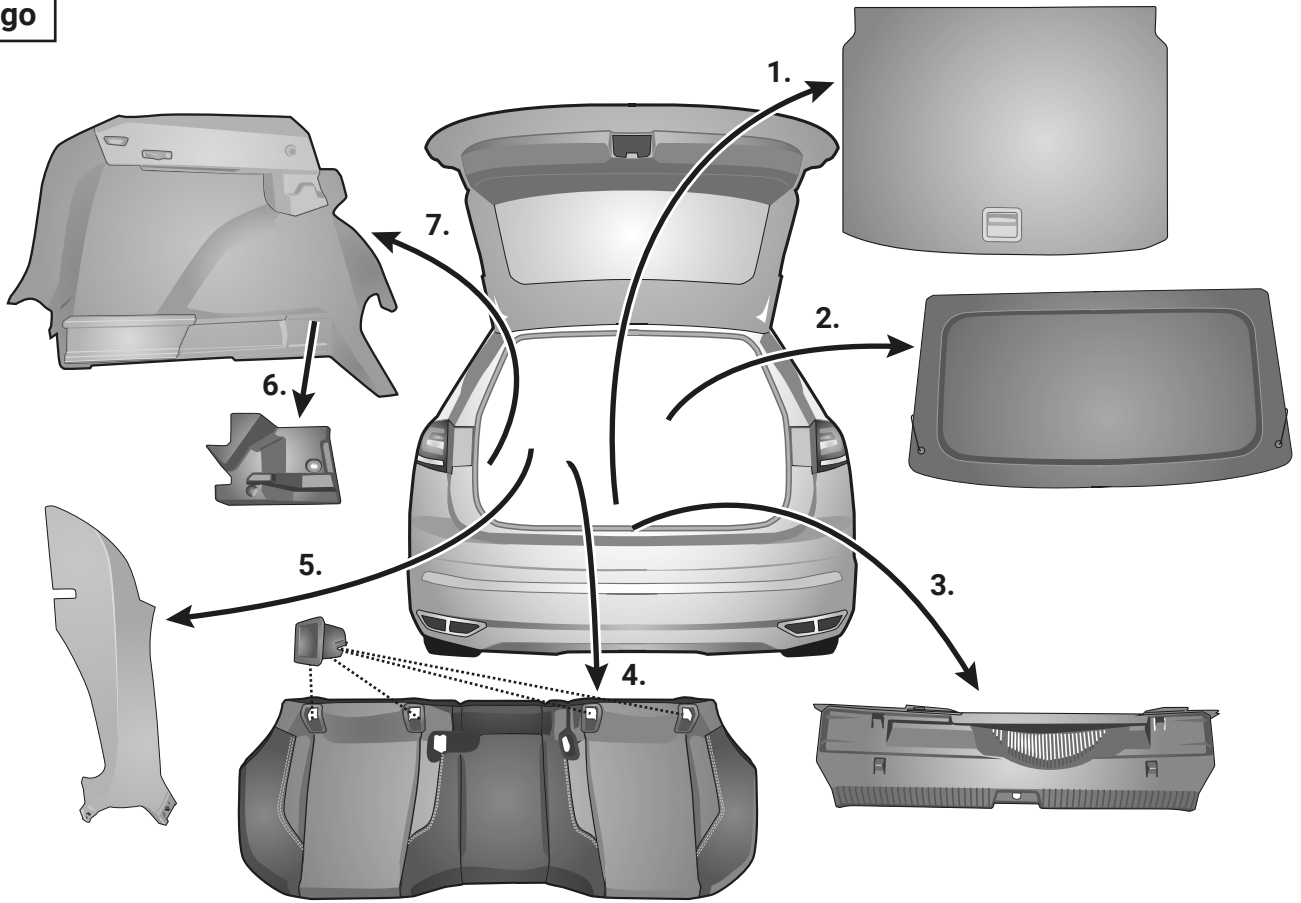

2

T-Cross

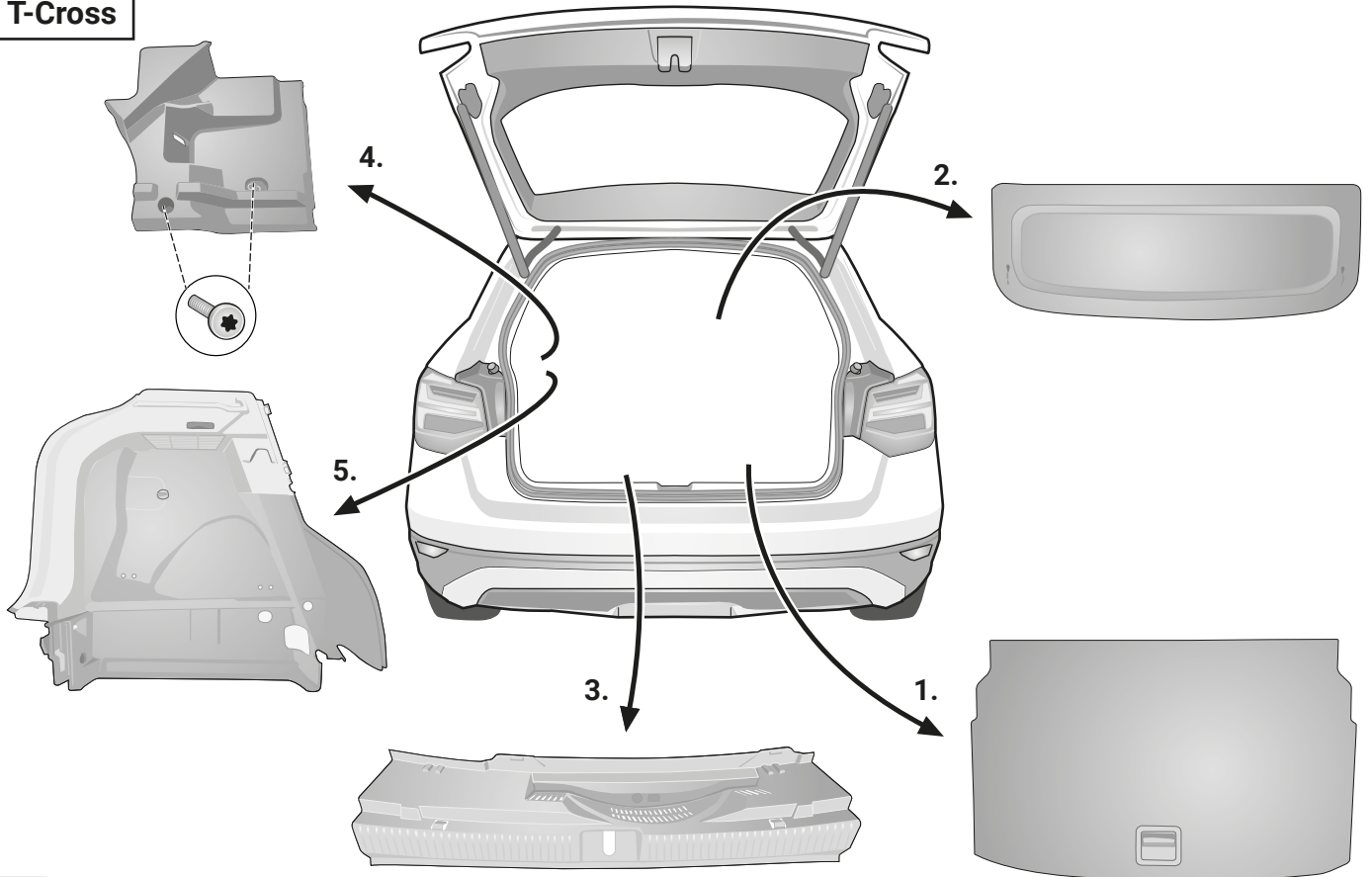

3

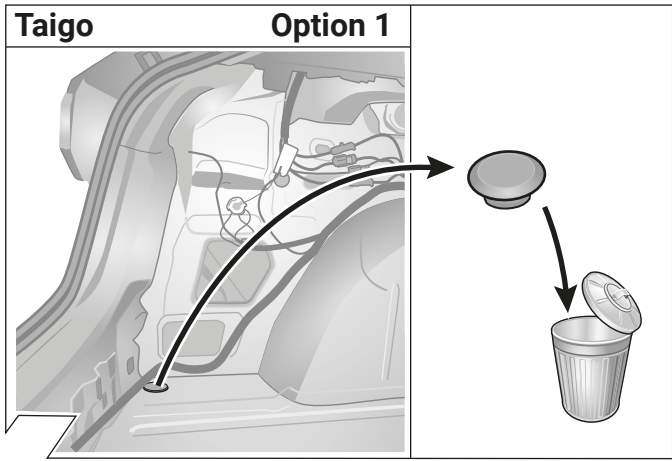

4

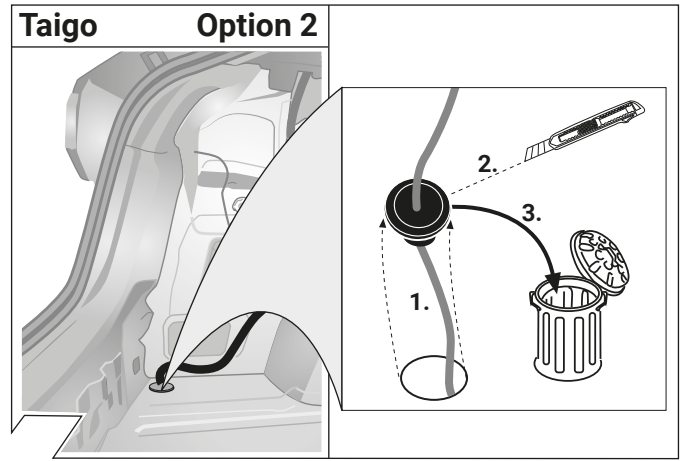

5

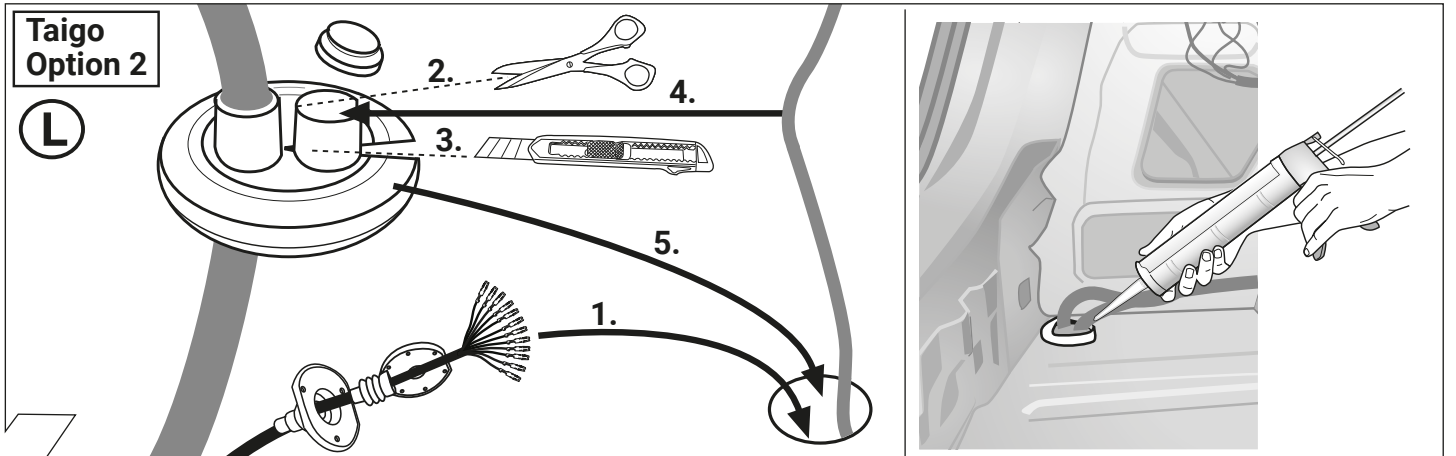

6

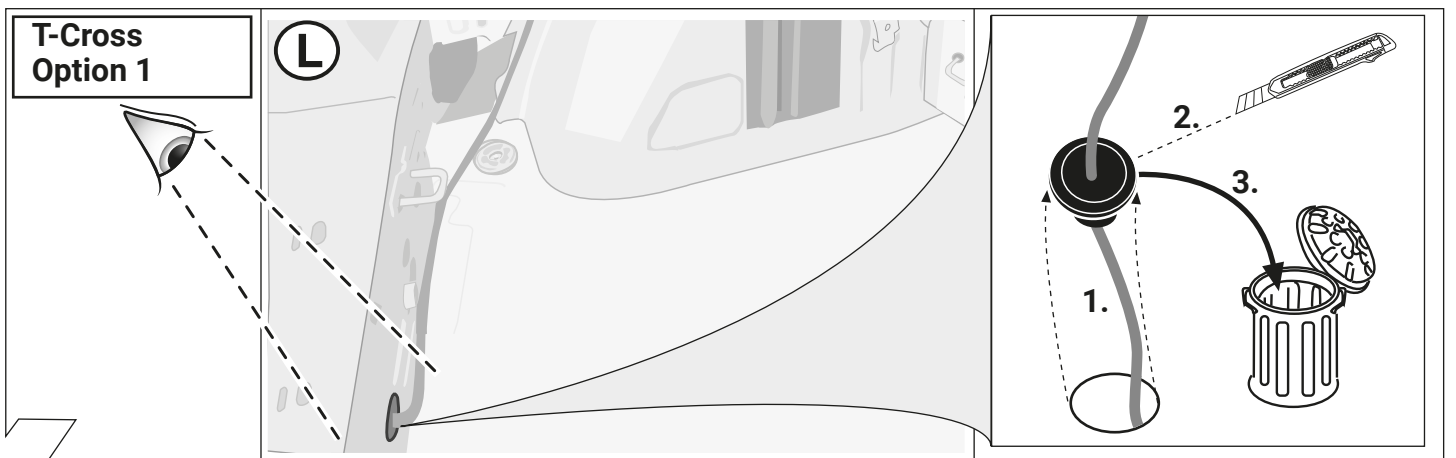

7

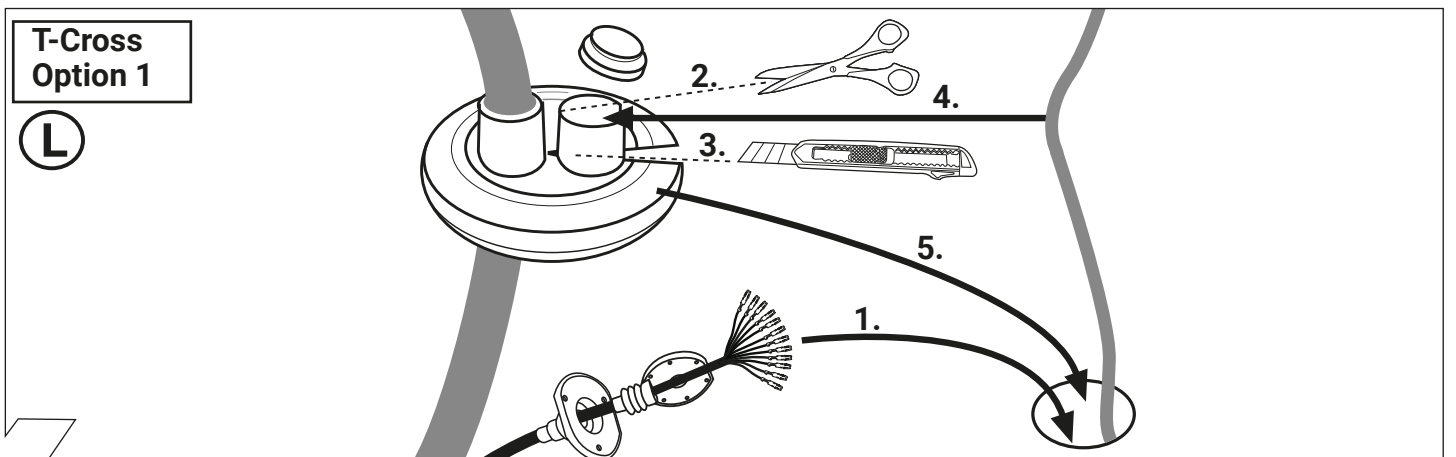

8

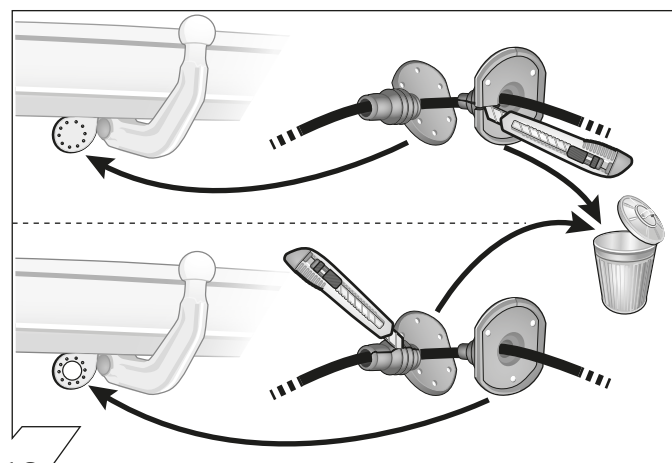
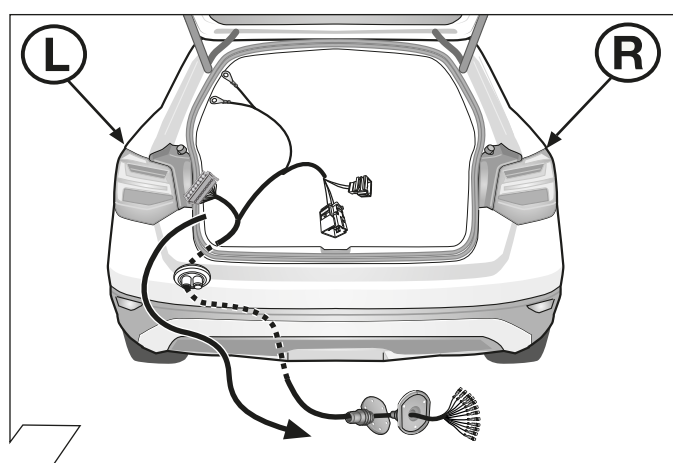
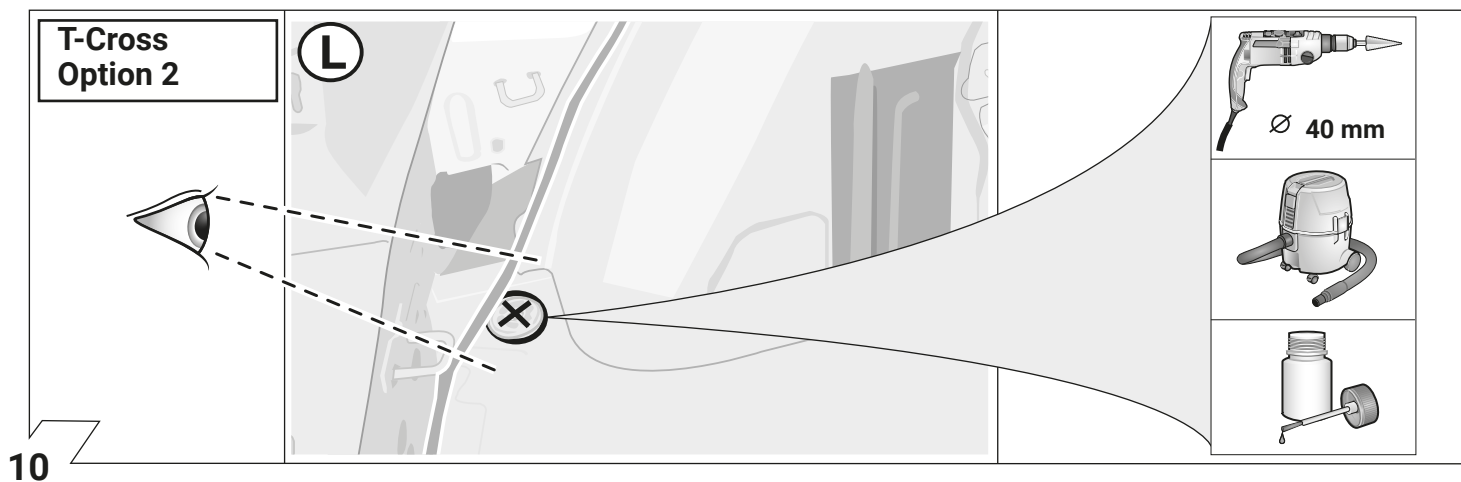
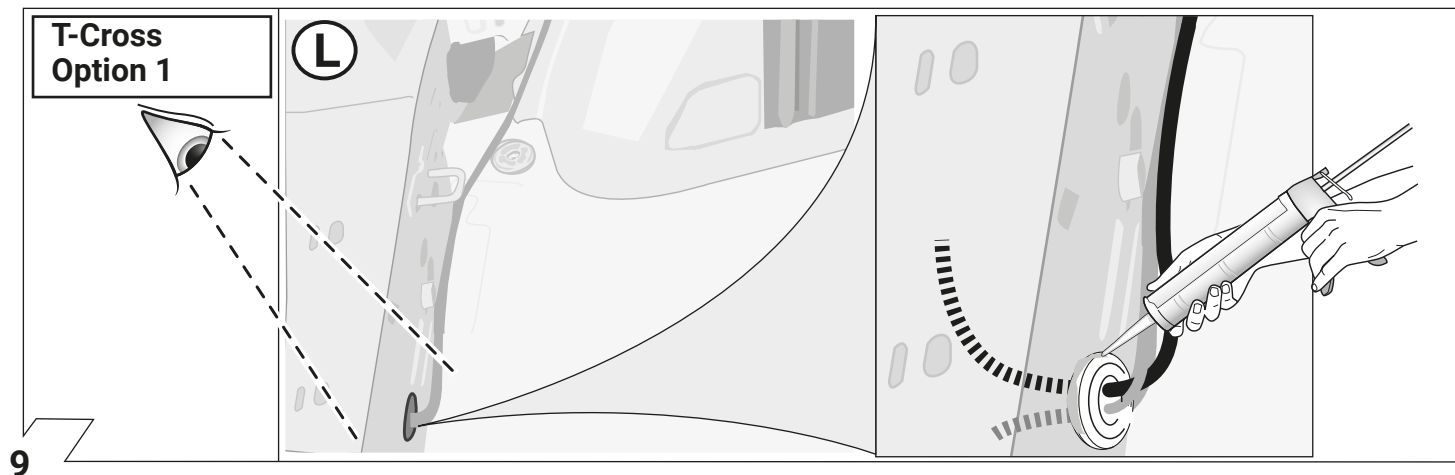

13

	GB	D	E	F	I	P	NL	DK	N	S	FIN	CZ	H	PL
BK	Black	Schwarz	Negro	Noir	Nero	Preto	Zwart	Sort	Svart	Svart	Musta	Černá	Fekete	Czarny
RD	Red	Rot	Rojo	Rouge	Rosso	Vermelho	Rood	Rød	Rød	Röd	Punainen	Červená	Piros	Czerwony
GN	Green	Grün	Verde	Vert	Verde	Verde	Groen	Grøn	Grønt	Grön	Vihreä	Zelená	Zöld	Zielony
OR	Orange	Orange	Naranja	Orange	Arancione	Laranja	Oranje	Orange	Orange	Orange	Oranssi	Oranzová	Narancs	Pomarańczowy
VT	Violet	Violett	Violeta	Violet	Viola	Violeta	Violet	Violet	Fiolett	Violett	Violetti	Fialová	Ibolya	Fioletowy
PK	Pink	Pink	Pink	Rose	Rosa	Cor-de-Rosa	Paars	Pink	Pink	Rosa	Pinkki	Růžová	Rózsaszín	Różowy
BL	Blue	Blau	Azul	Bleu	Blu	Azul	Blauw	Blå	Blått	Blå	Sininen	Modrá	Kék	Niebieski
YL	Yellow	Gelb	Amarillo	Jaune	Giallo	Amarelo	Geel	Gul	Gult	Gul	Keltainen	Zlutá	Sárga	Żółty
WT	White	Weiss	Blanco	Blanc	Bianco	Branco	Wit	Hvid	Hvitt	Vt	Valkoinen	Bílá	Fehér	Biały
BR	Brown	Braun	Marrón	Brun	Marrone	Marron	Bruin	Brun	Brunt	Brun	Ruskea	Hnědá	Barna	Brazowy
GY	Grey	Grau	Gris	Gris	Grigio	Cinzeno	Grijs	Grå	Grått	Grå	Harmaa	Sedá	Szürke	Szary

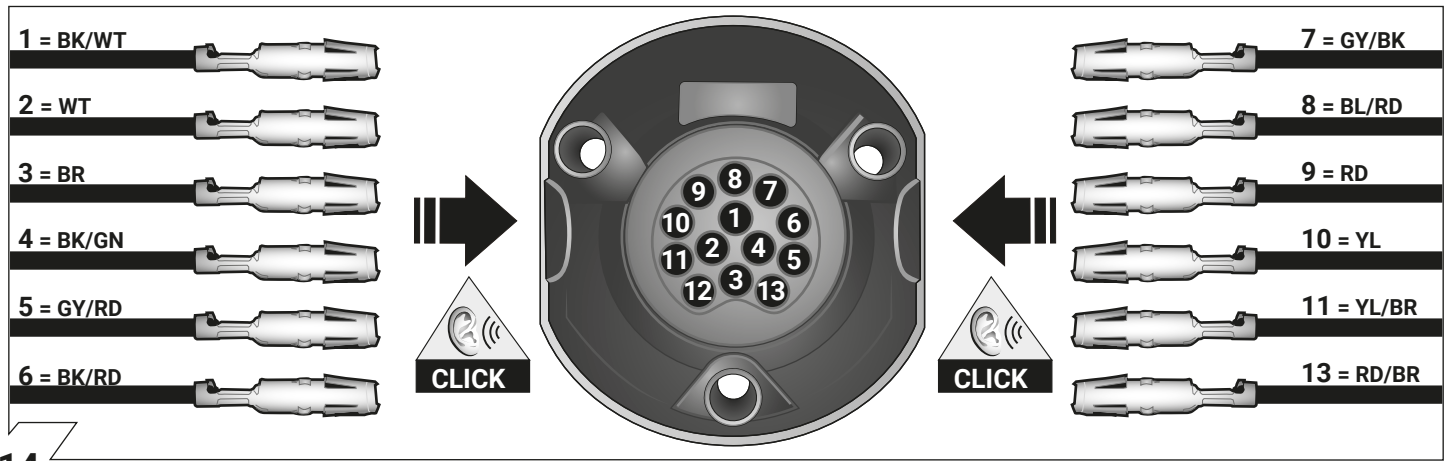

14

ISO 11446	Belegung der Steckdose / Maximale Ausgangsleistung Socket configuration / Maximum power output Correspondance des contacts de la prise / Puissance de sortie maximale Abbinamento della presa / Uscita di alimentazione massima Indeling van de stekkerdoos / maximaal uitgangsvermogen			
	1/L	BK/WT	21W	
	2	WT	42W	
	1-8	3/31	BR	
	4/R	BK/GN	21W	
	5/58-R	GY/RD	52W	
	6/54	BK/RD	63W	
	7/58-L	GY/BK	52W	
	8	BL/RD	42W	
	9	RD	240W	
	10	YL	180W	
	11	YL/BR		
	12			
	13	RD/BR		

15

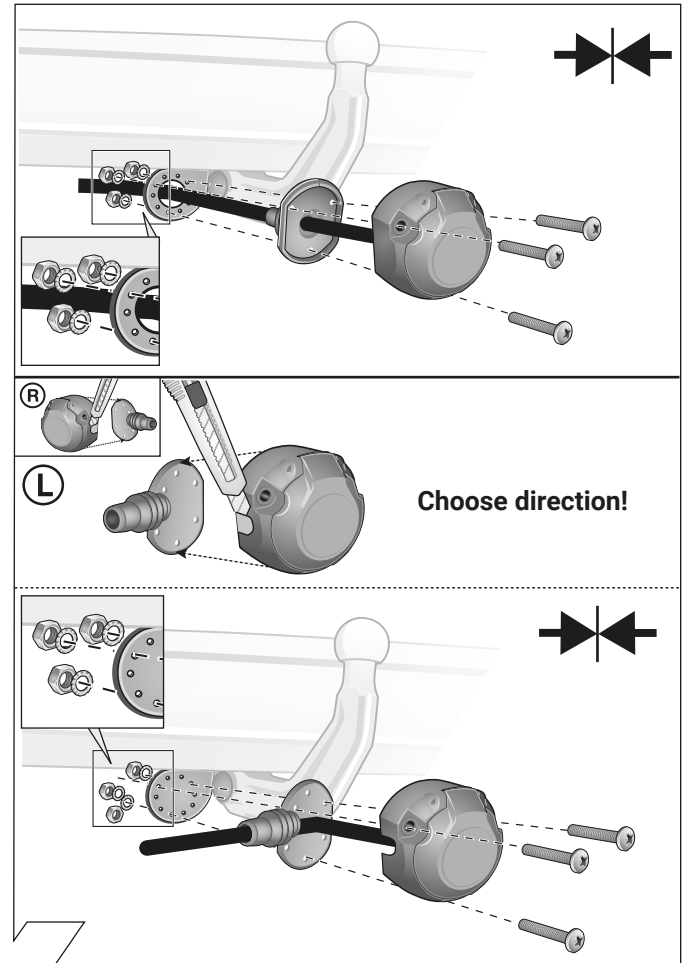

16

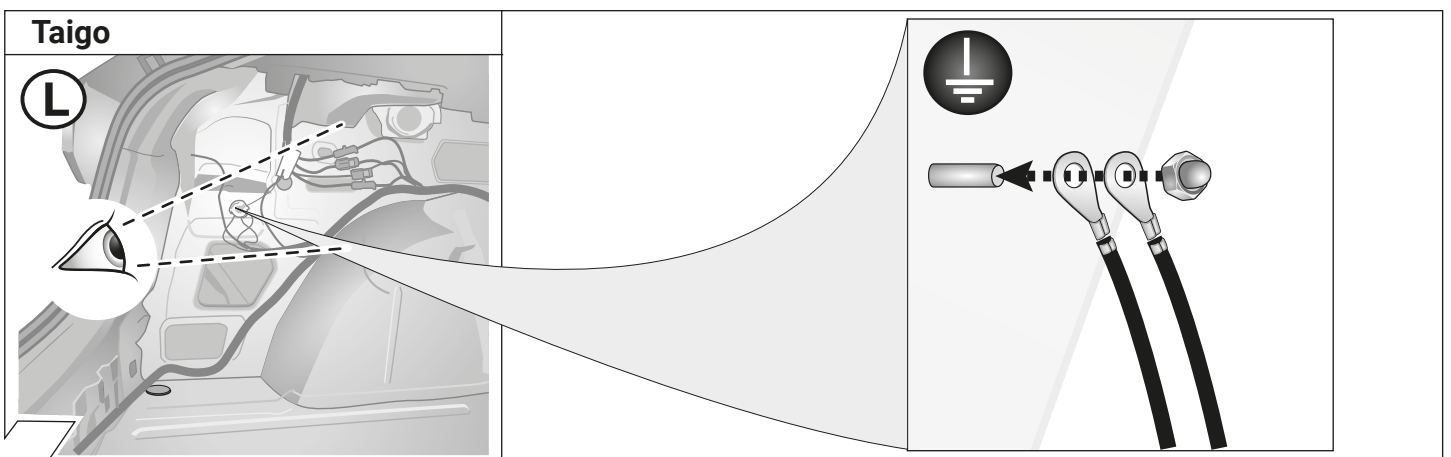

17

Taigo

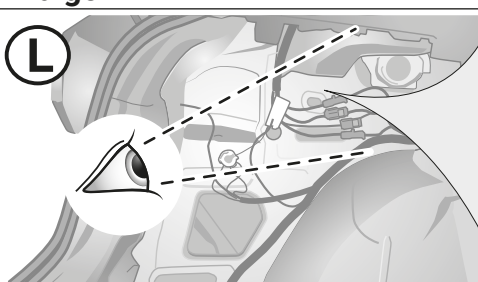

Option 1



Option 2

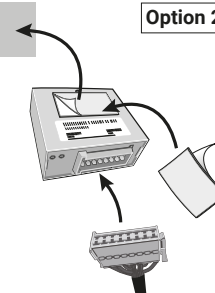



Important!
Please note
informations in
picture 1!

Important!
Check before connecting: Vehicles with UNECE
PR code: NI1, NI7, NI8 and NI9 cannot be coded at the
current status!



18

T-Cross



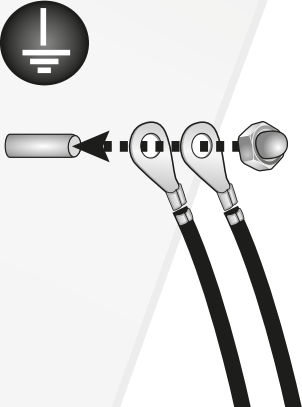

19

T-Cross



Option 1

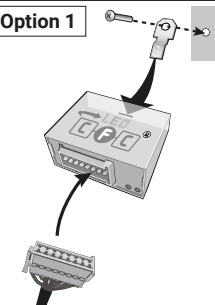

Option 2

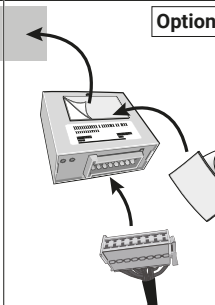



Important!
Please note
informations in
picture 1!

Important!
Check before connecting: Vehicles with UNECE
PR code: NI1, NI7, NI8 and NI9 cannot be coded at the
current status!



20

L

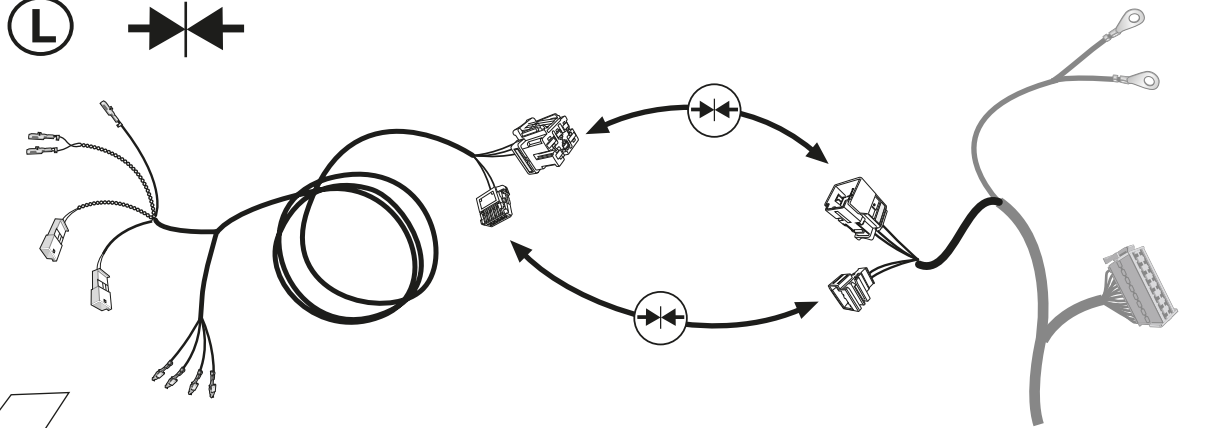

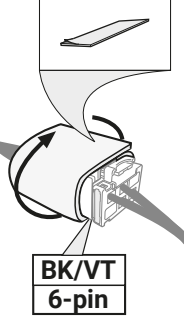

BK/VT
6-pin

21

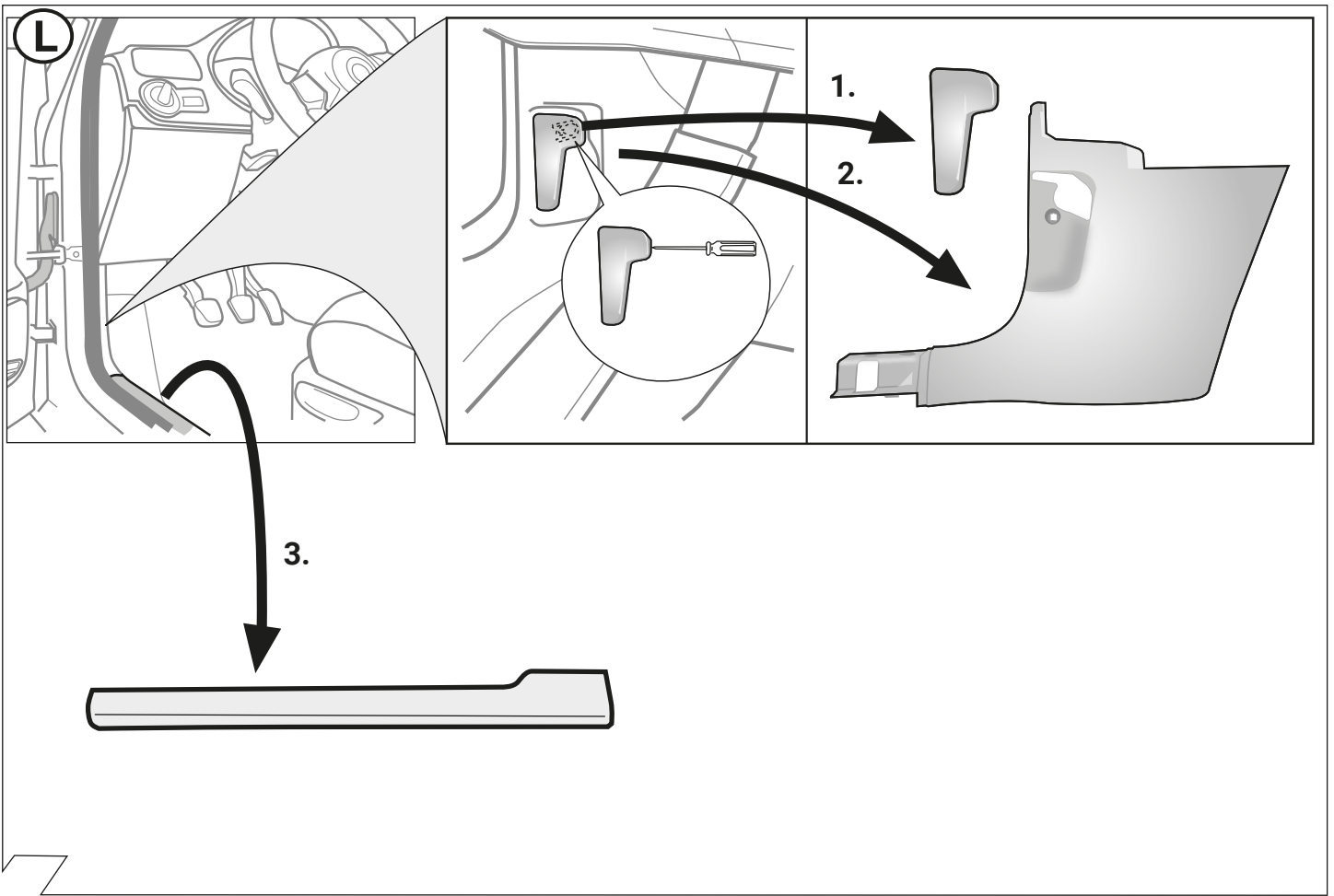

22

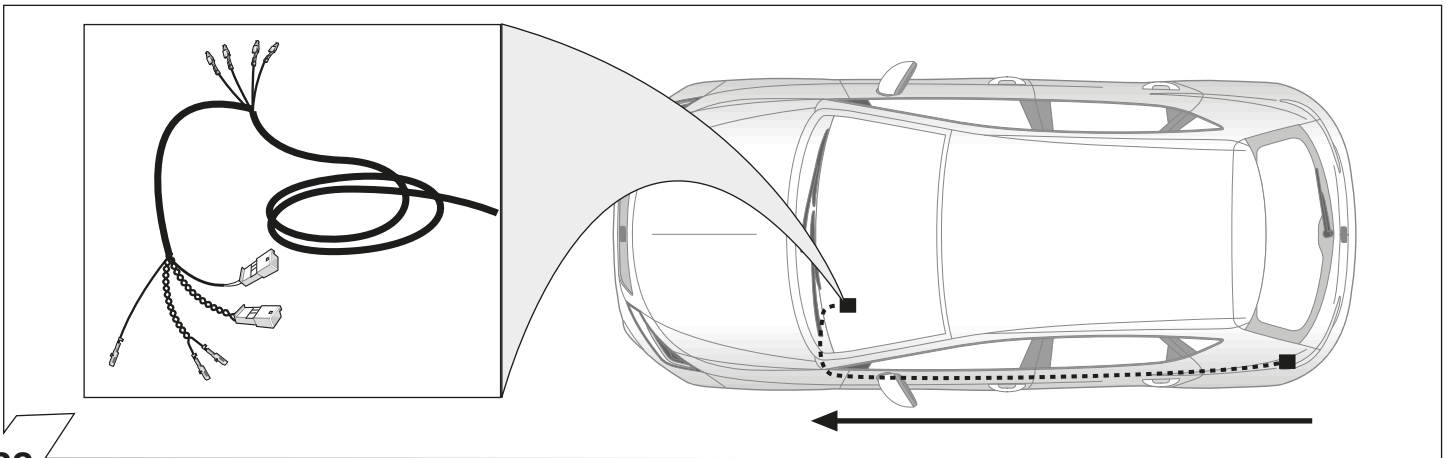

23

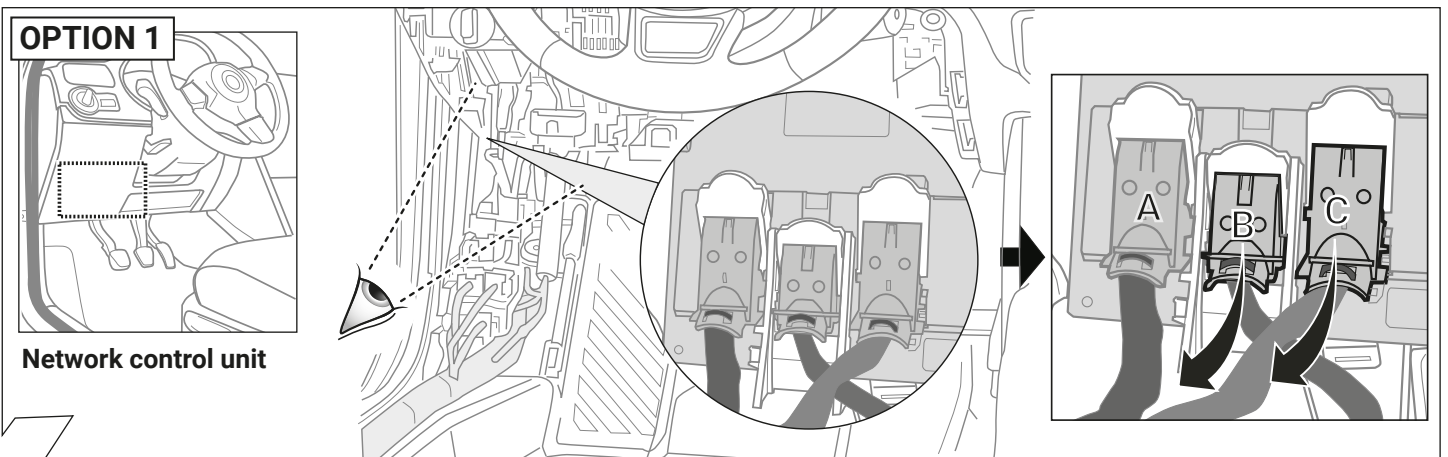

24

OPTION 1 Taigo BCM-C CAN

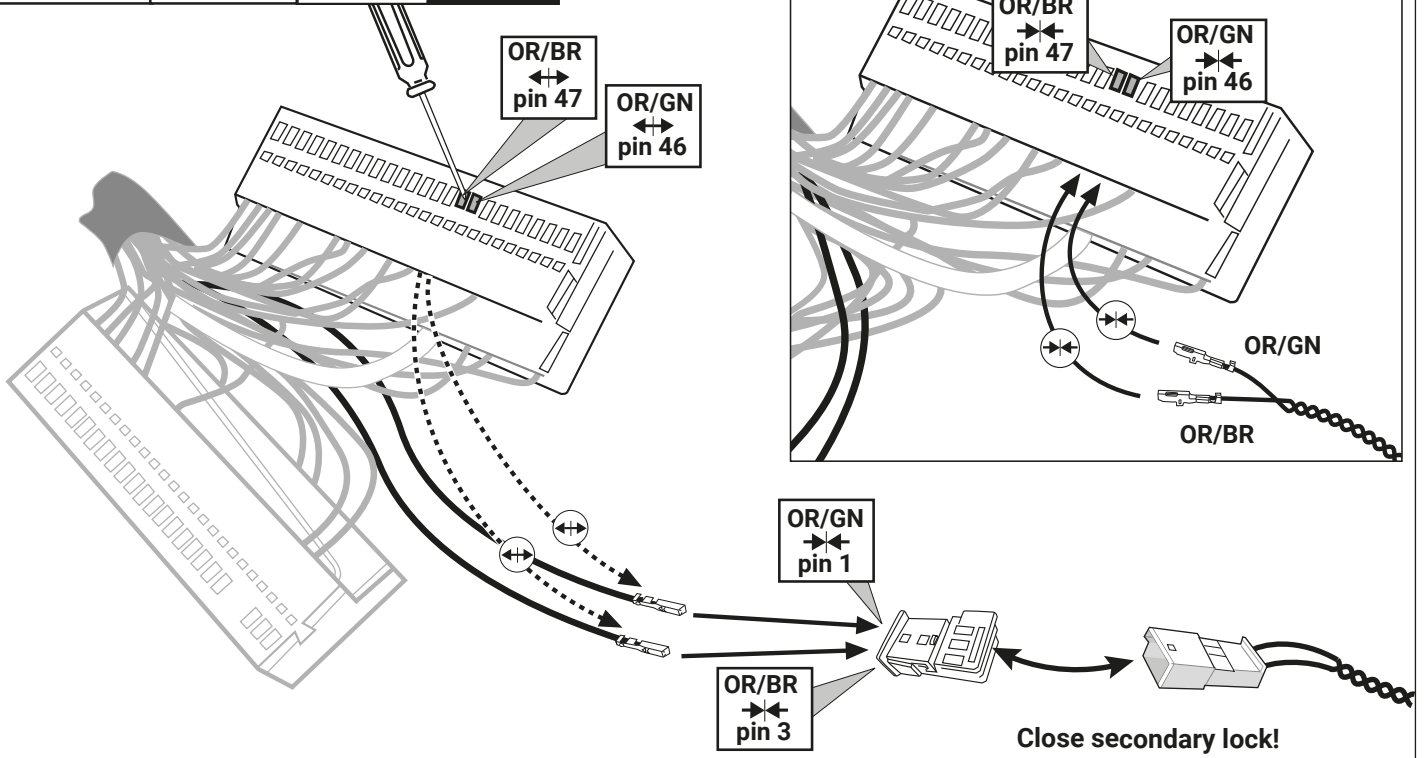

25

OPTION 1 Taigo BCM-B

STOP

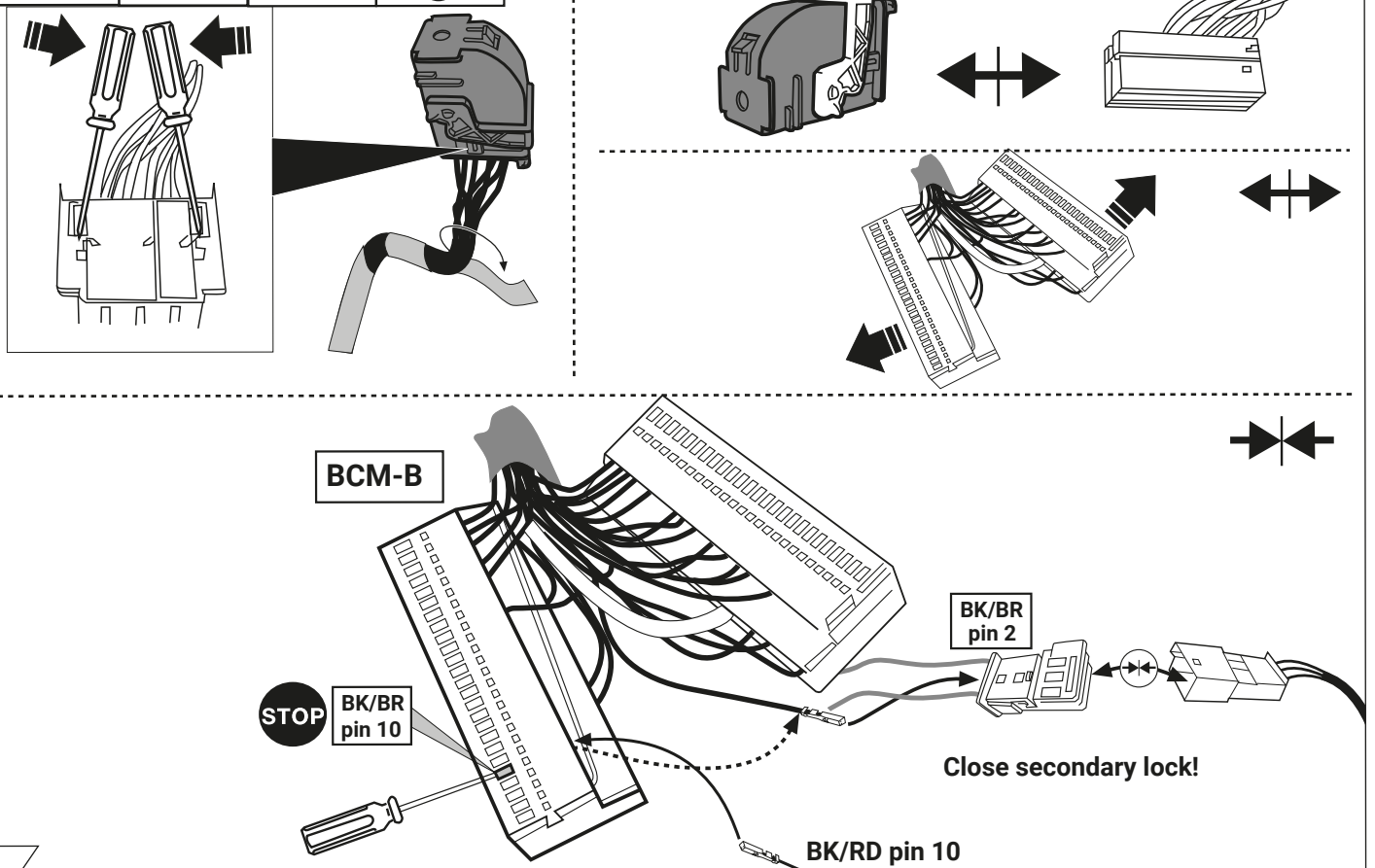

26

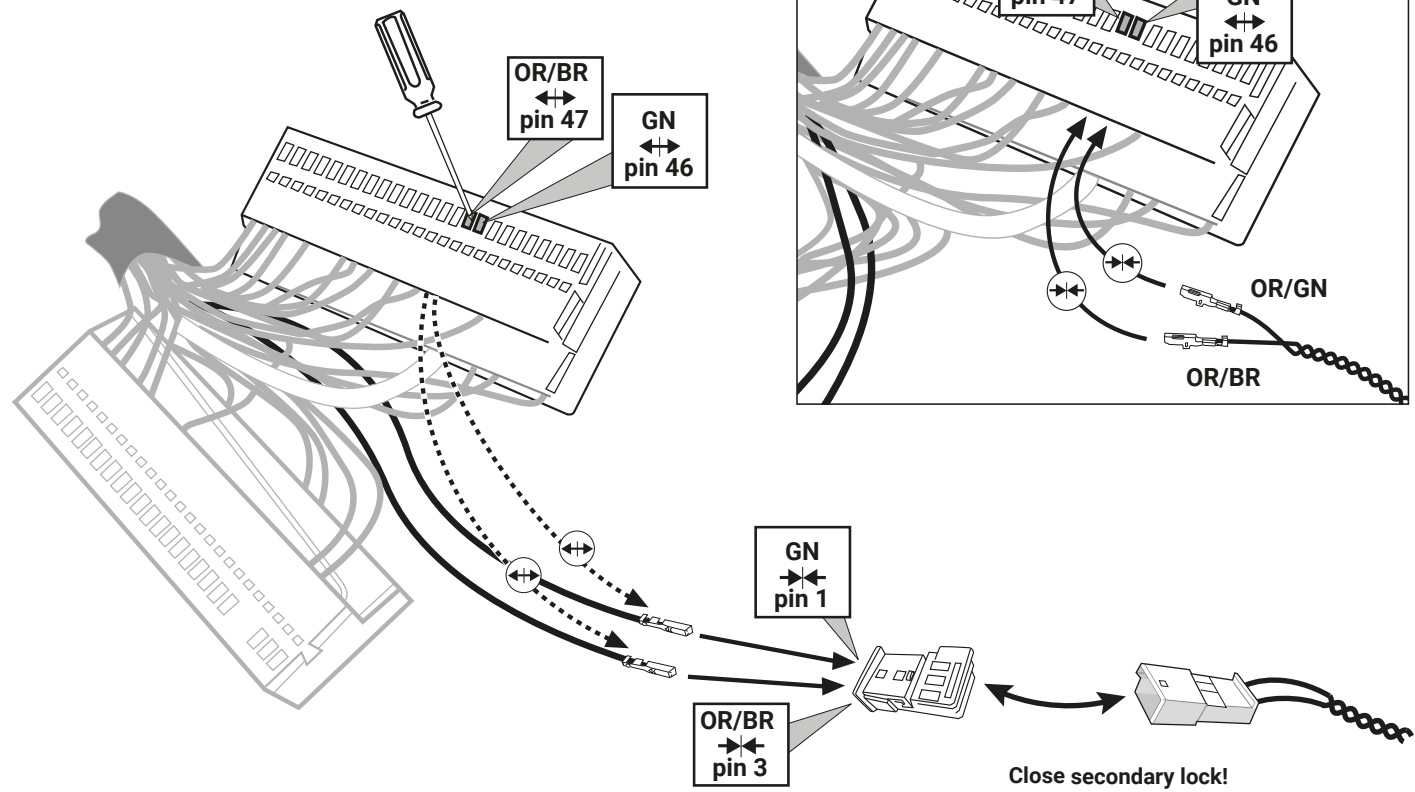

27

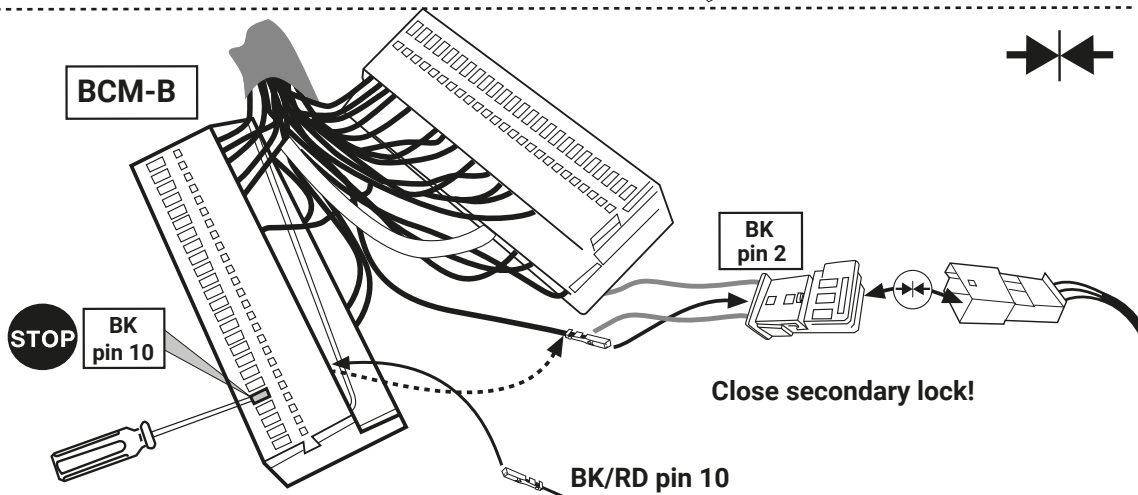
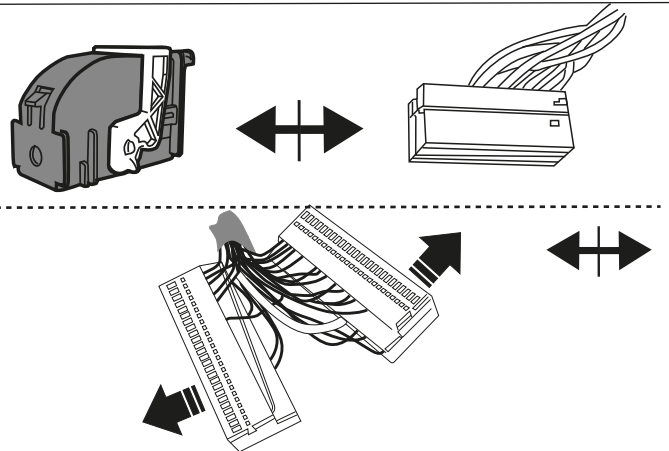
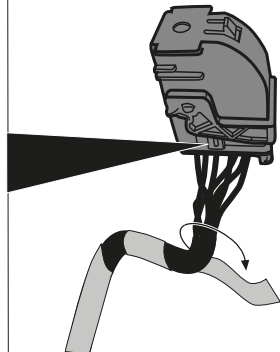
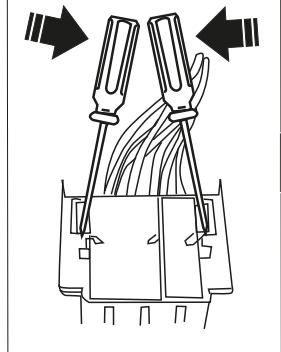

28

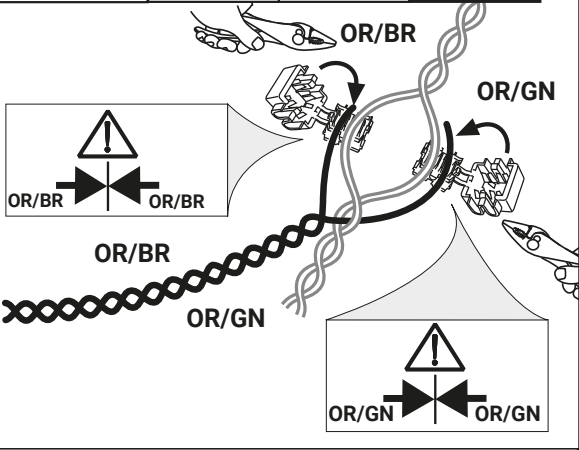

Important! Please note informations in picture 1!

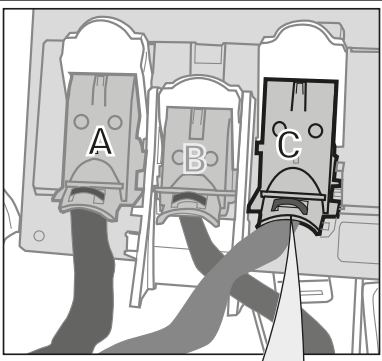

CAN-Data Wire
 OR/BR (chamber 47)
 OR/GN (chamber 46)

Body Control Module connector C

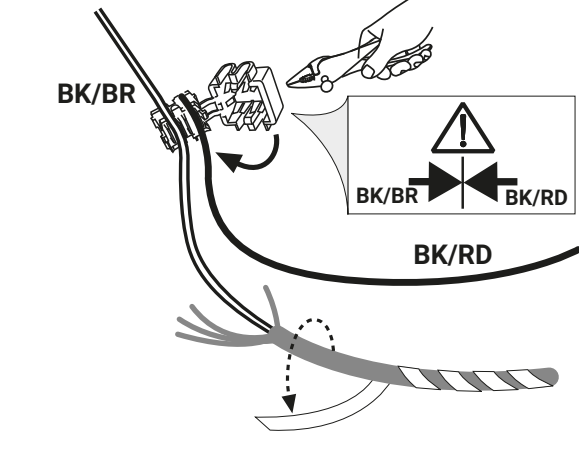
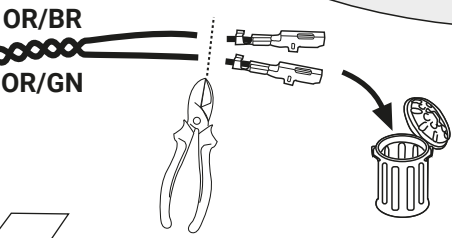
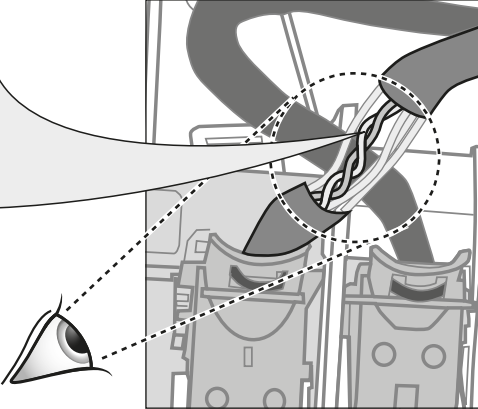

Important! Please note informations in picture 1!

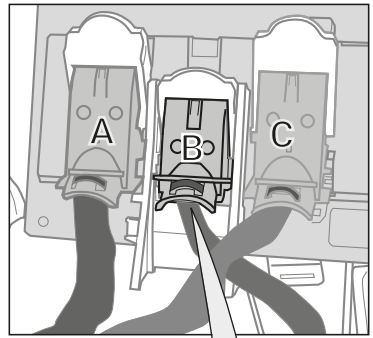

STOP BK/BR
 BK/BR (chamber 10)

Network control unit connector B

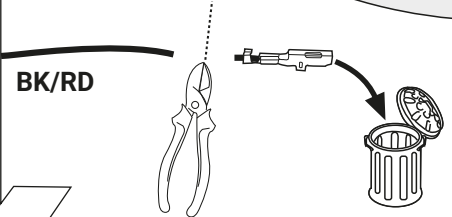
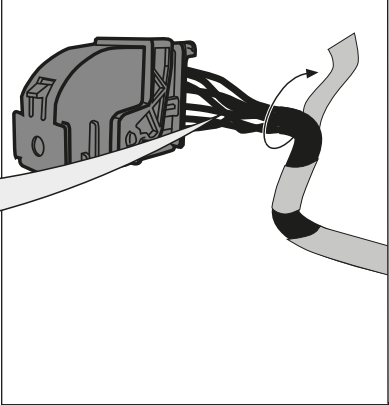

OPTION 2 | **T-Cross** | **BCM-C** | **CAN**

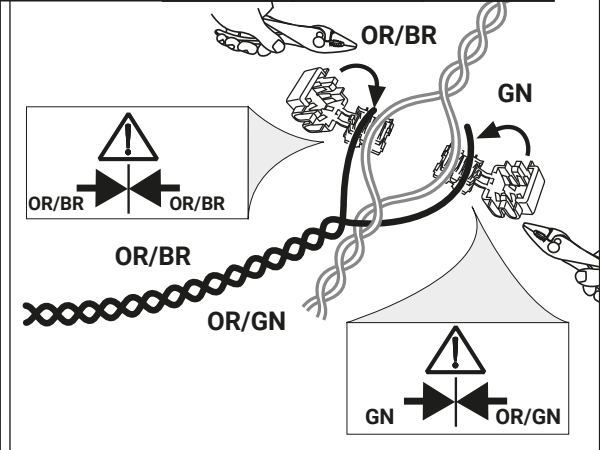

Important! Please note informations in picture 1!

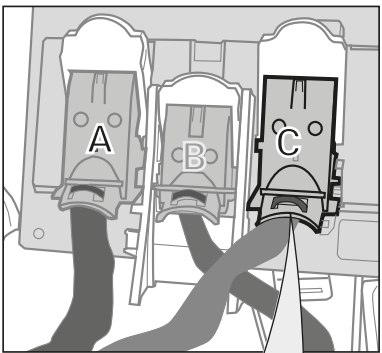

CAN-Data Wire
 OR/BR (chamber 47)
 GN (chamber 46)

Body Control Module connector C

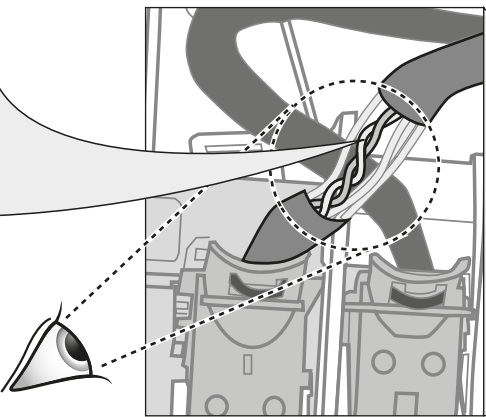
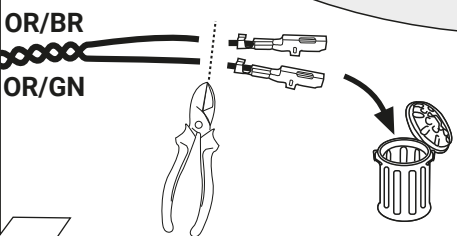

31

OPTION 2 | **T-Cross** | **BCM-B** | **STOP**

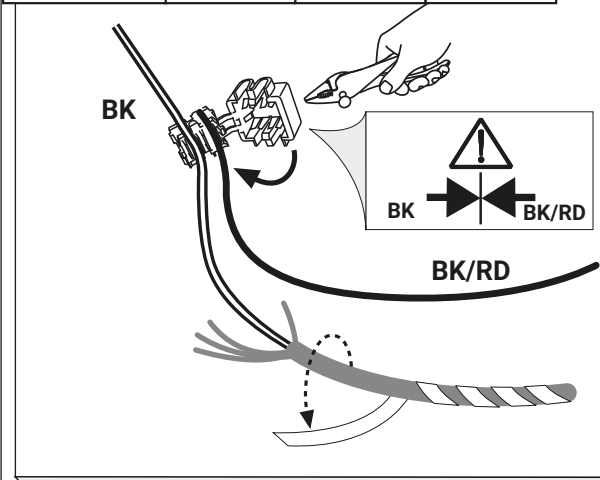

Important! Please note informations in picture 1!

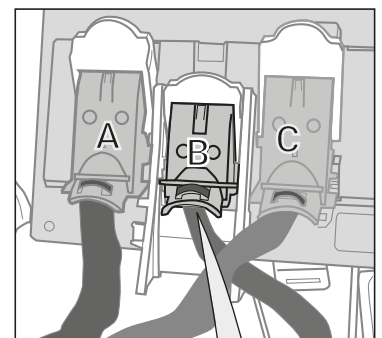

STOP BK
 BK (chamber 10)

Network control unit connector B

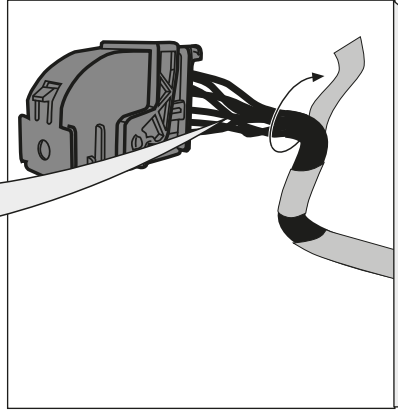
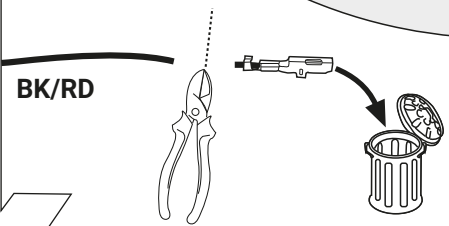

32

OPTION 2

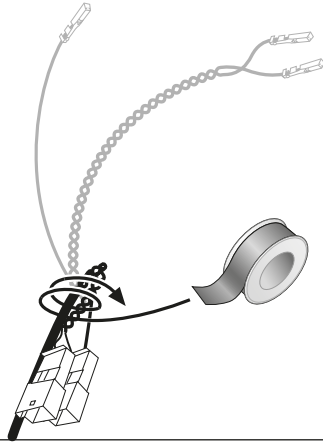

33

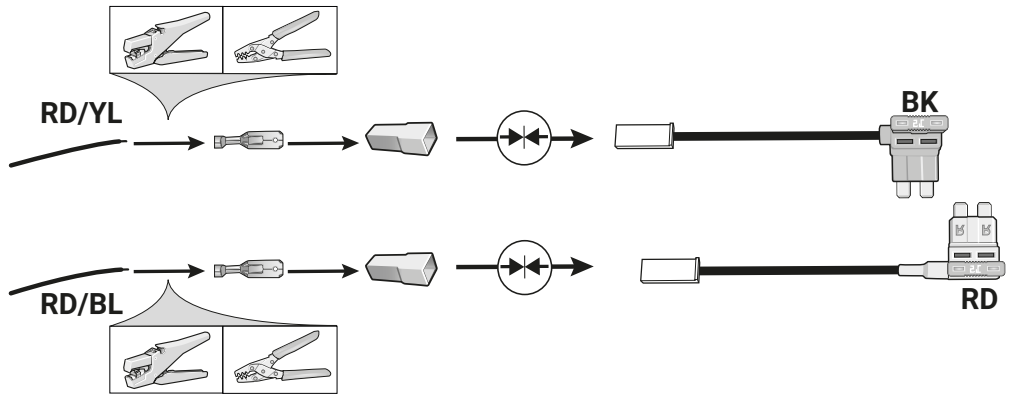
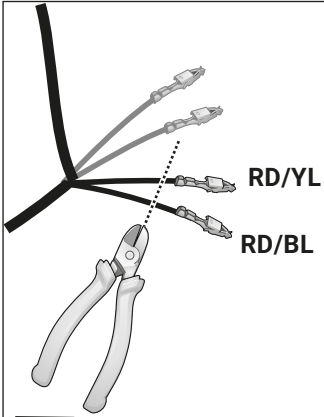

34

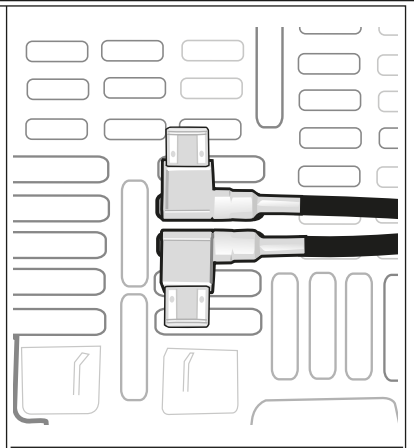
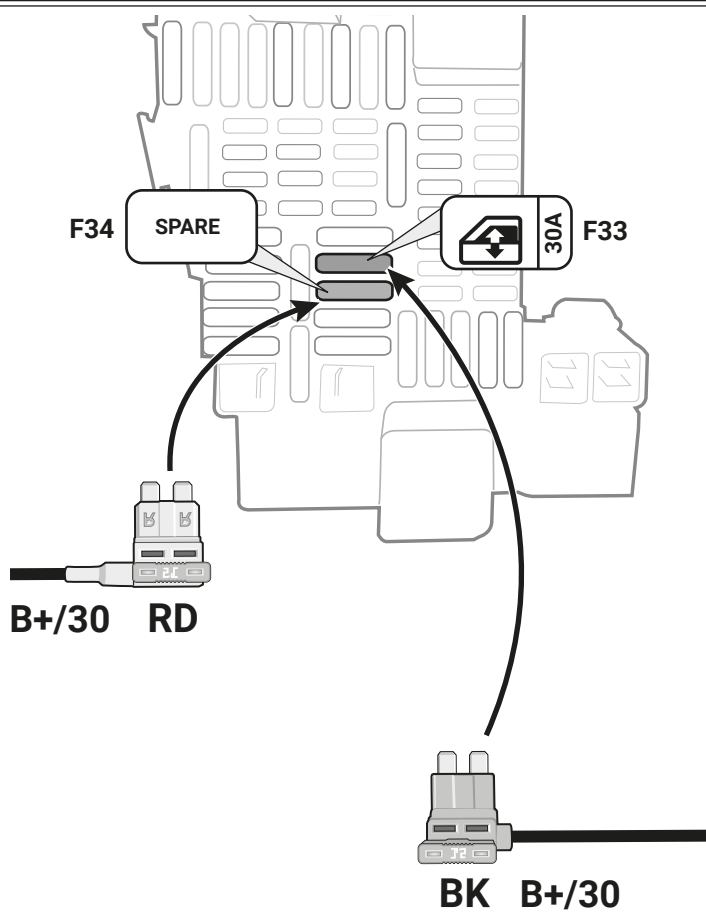
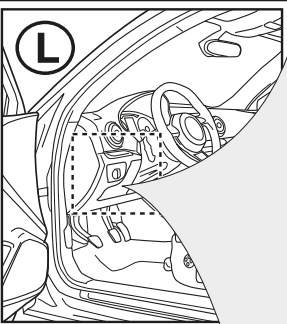

Important!
Please do not mount the fuse tap and its wiring output in the other direction!

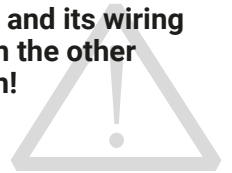

35

OPTIONAL

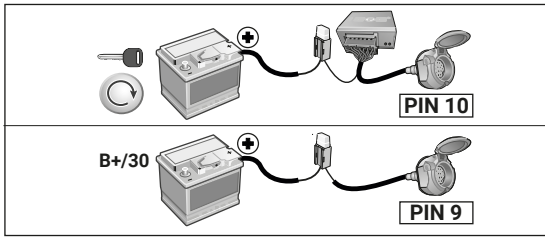
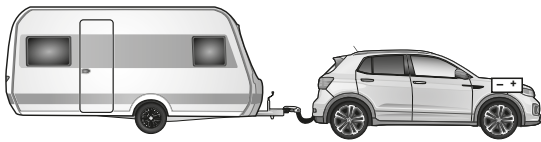

Part-no.
22500669



52 - 57

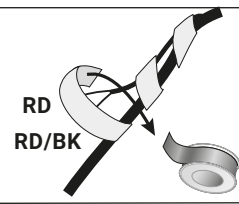

36

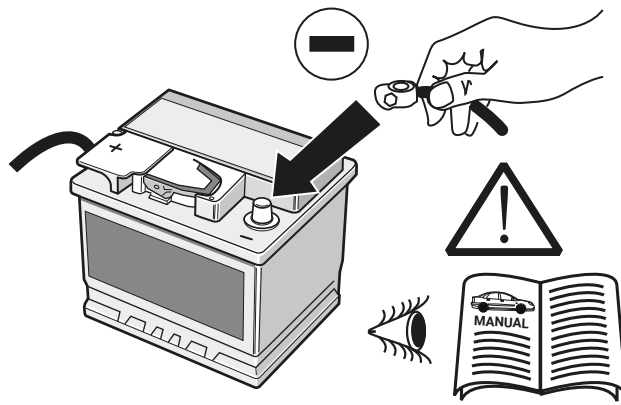

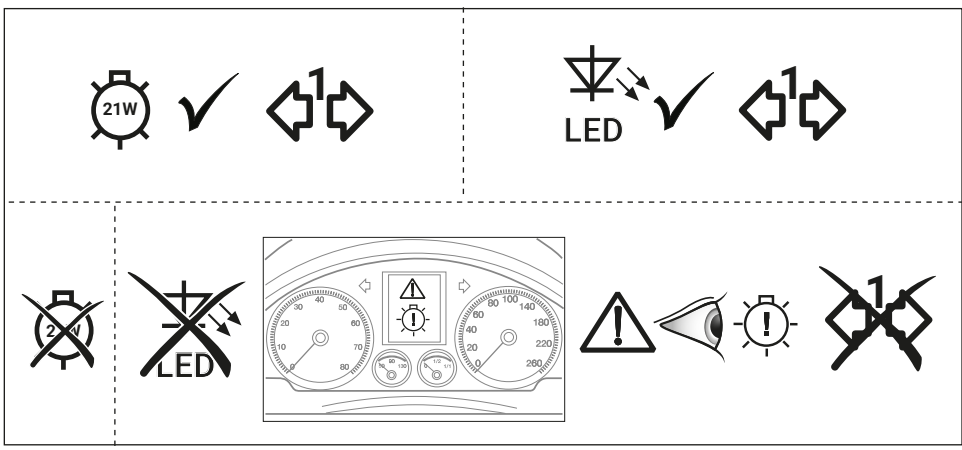
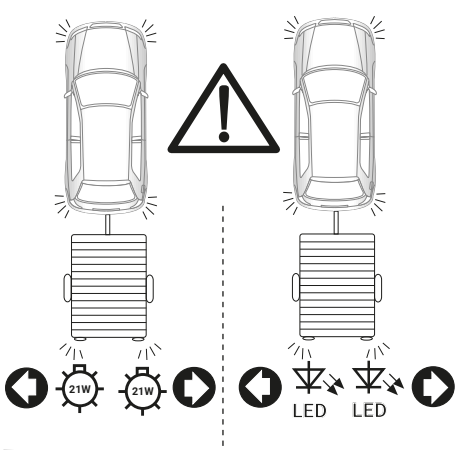
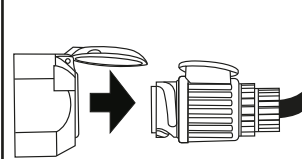
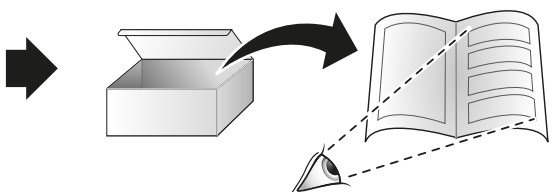
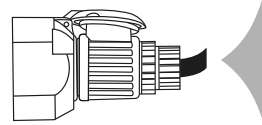
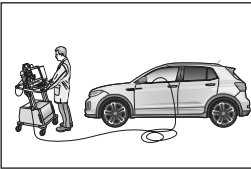

37

OPTION 1







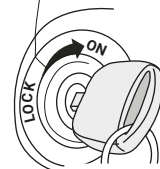
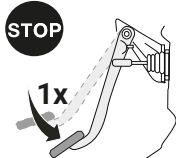

38

OPTION 1

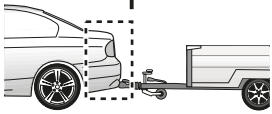

SETUP

- 
-  Ignition ON
- 
-   





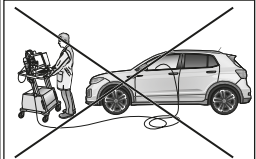

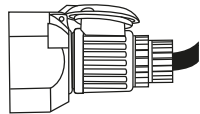

39

OPTION 2

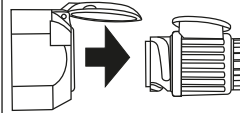



→ 47 - 51





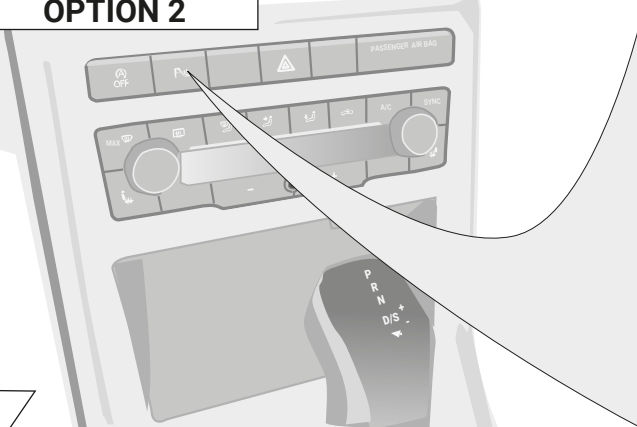



40

OPTION 2



Vehicles with Factory-Fitted PDC-System!







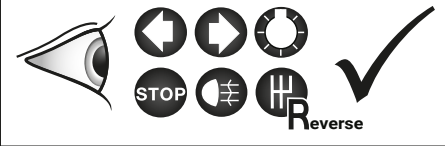
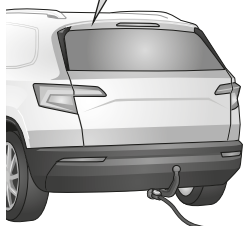



41

OPTIONAL

Trailer Simulator for 7- and 13-pin Sockets

42

<p>D Folgende Beleuchtungsfunktionen des Anhängers werden nicht bei allen Zugfahrzeugen mit Tagesfahrlichtschaltung unterstützt:</p> <ul style="list-style-type: none"> • Schlussleuchten • Begrenzungsleuchten • Kennzeichenbeleuchtung <p>Zur Aktivierung dieser Funktionen muss Stand- oder Abblendlicht eingeschaltet werden!</p> 	<p>I Le seguenti funzioni per l'illuminazione del rimorchio non sono supportate da tutte le motrici con circuito di luci diurne:</p> <ul style="list-style-type: none"> • luci posteriori • luci d'ingombro • illuminazione targa <p>Per attivare queste funzioni devono essere accese le luci di posizione o gli anabbaglianti!</p> 
<p>GB The following light functions for the trailer are not supported by all towing vehicles with DRL circuit:</p> <ul style="list-style-type: none"> • Rear lights • Side lights • Numberplate lights <p>The taillights or dimmed headlights must be switched on to activate this function!</p> 	<p>NL De volgende verlichtingsfuncties van de aanhanger worden niet bij alle trekkende voertuigen met daglichtschakeling ondersteund:</p> <ul style="list-style-type: none"> • Achterlichten • Spatbordlampen • Kentekenverlichting <p>Ter activering van deze functies moet parkeer- of dimlicht worden ingeschakeld!</p> 
<p>F Les fonctions d'éclairage suivantes de la remorque ne sont pas activables sur tous les véhicules de traction équipés de feux de circulation de jour:</p> <ul style="list-style-type: none"> • Feux arrières • Feux d'encombrement • Éclairage de la plaque minéralogique <p>Pour activer ces fonctions, les feux de position ou de croisement doivent être allumés!</p> 	<p>ES No todos los vehículos tractores con conmutación de luz de marcha diurna ofrecen un soporte para las siguientes funciones de iluminación del remolque:</p> <ul style="list-style-type: none"> • Luces traseras • Luces de gálibo • Iluminación de la matrícula <p>¡Para activar estas funciones deberán encenderse las luces de posición o las luces de cruce!</p> 
<p>PL Niektóre funkcje oświetlenia przyczepy nie są aktywne w samochodach ktore sa wyposażone w przełącznik świateł dziennych:</p> <ul style="list-style-type: none"> • światła pozycyjne (tylne) • światła obrysowe • oświetlenie tablicy rejestracyjnej <p>W celu aktywacji tych funkcji muszą być włączone światła postojowe lub pozycyjne.</p> 	<p>SK Nasledujúce funkcie osvetlenia privesu nie sú podporované pri všetkých taháčoch so spínaním denného svetla počas jazdy:</p> <ul style="list-style-type: none"> • koncové (zadné) svetlá • obrysové svetlá • osvetlenie SPZ <p>K aktivovaniu týchto funkcií musí byť zapnuté parkovacie svetlo alebo tmné svetlo.</p> 

43

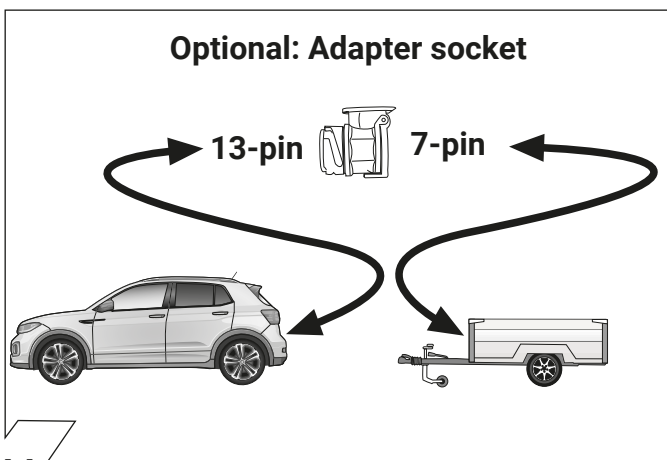

44

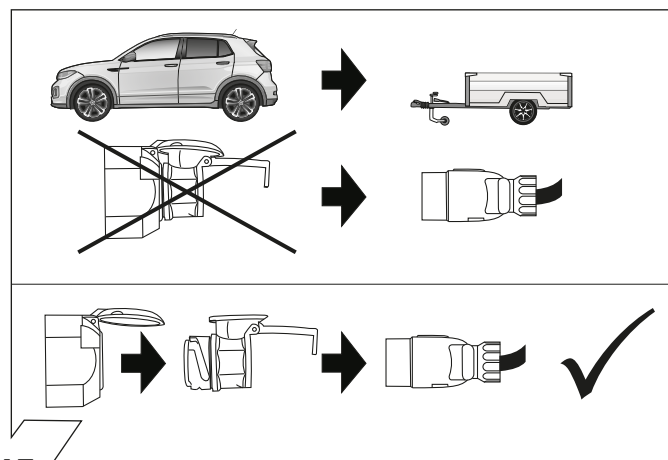

45

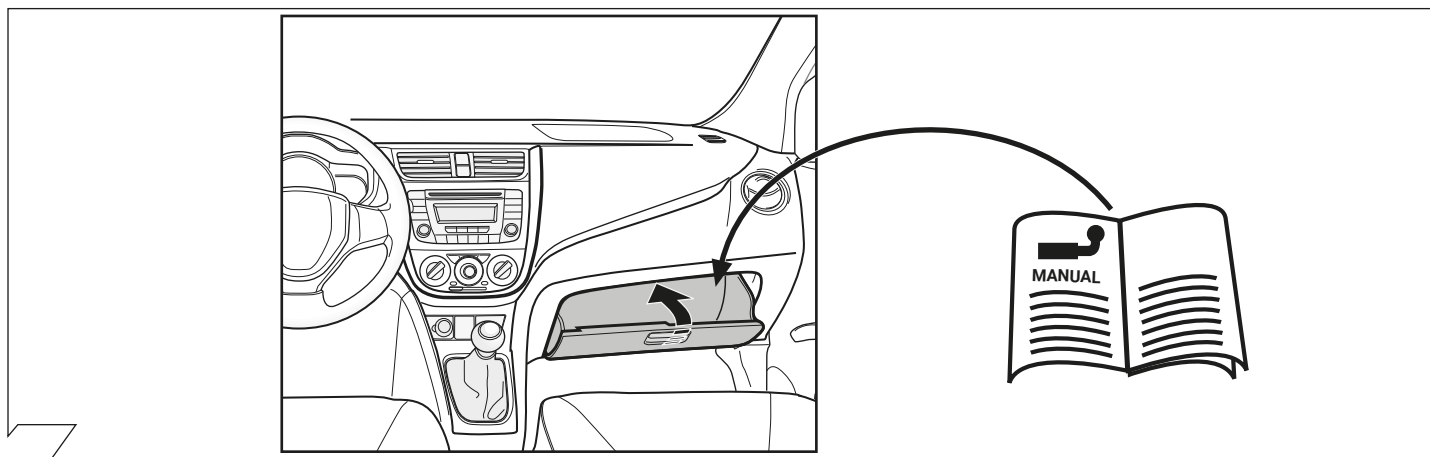

46

OPTION 2



47

OPTION 2

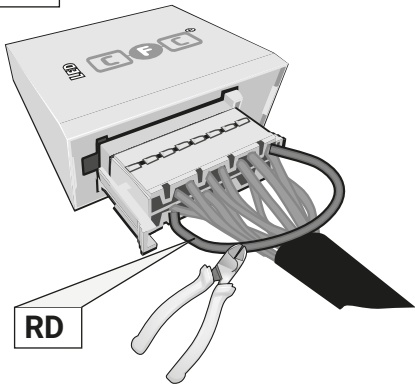

Pin 11 and Pin 2 disconnected

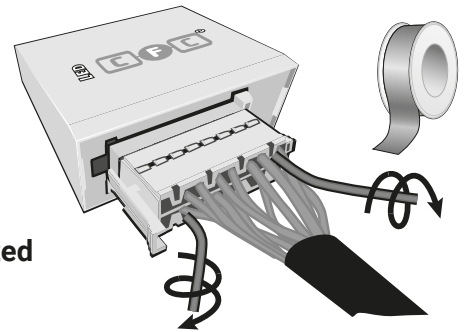

48

OPTION 2

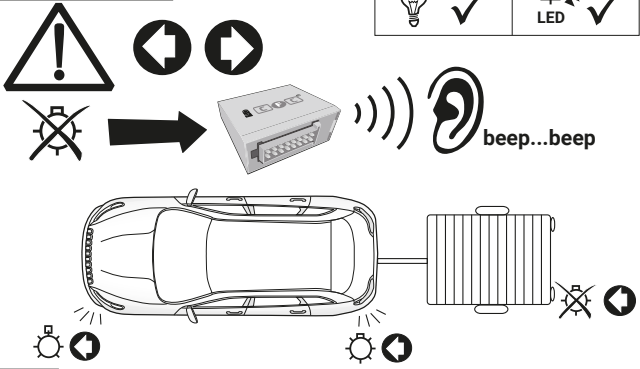

49

OPTION 2

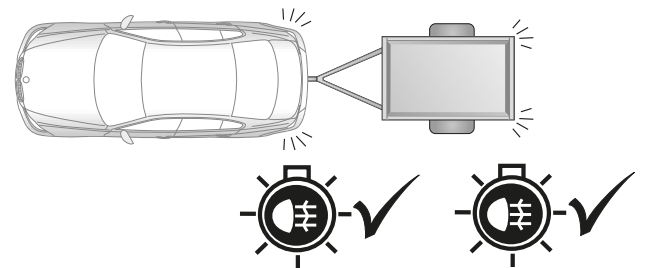

50

OPTION 2

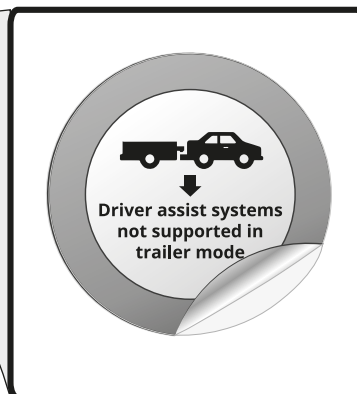
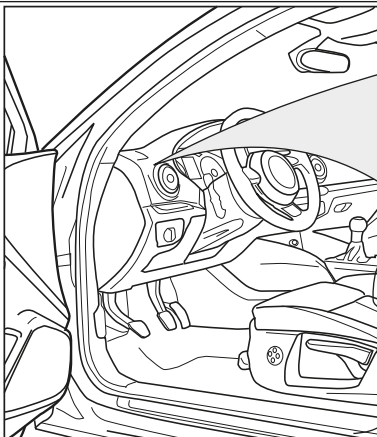

51

No. 22500669 EXTENSION KIT

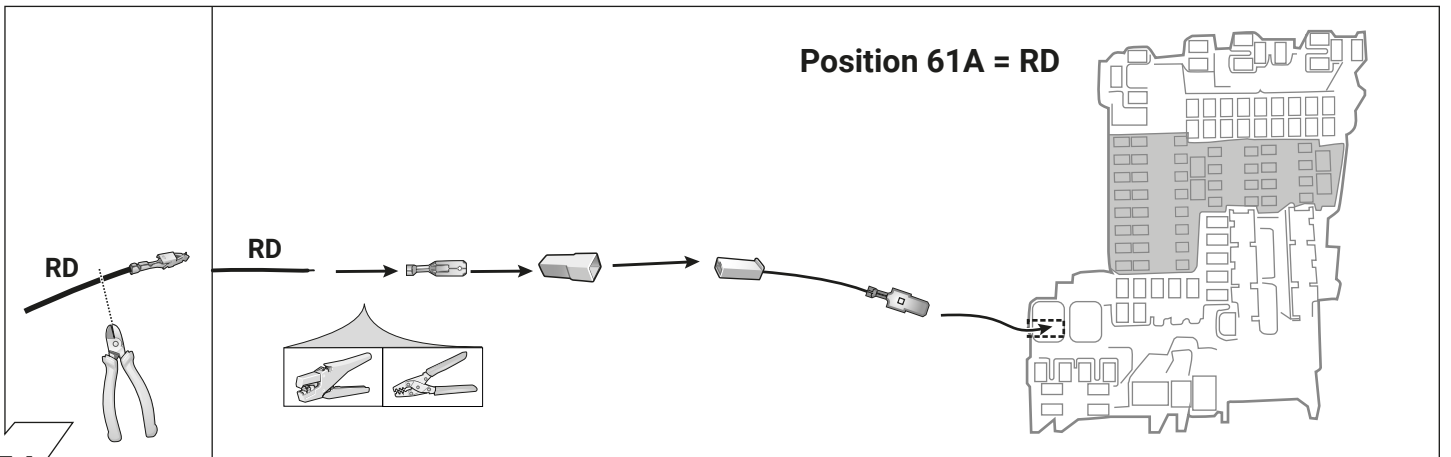
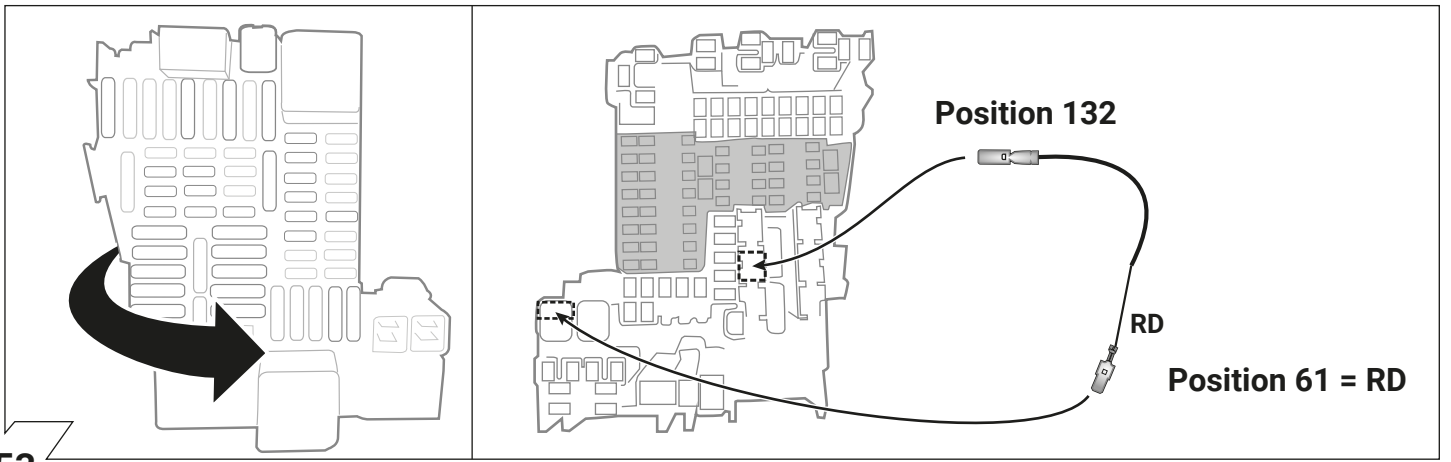
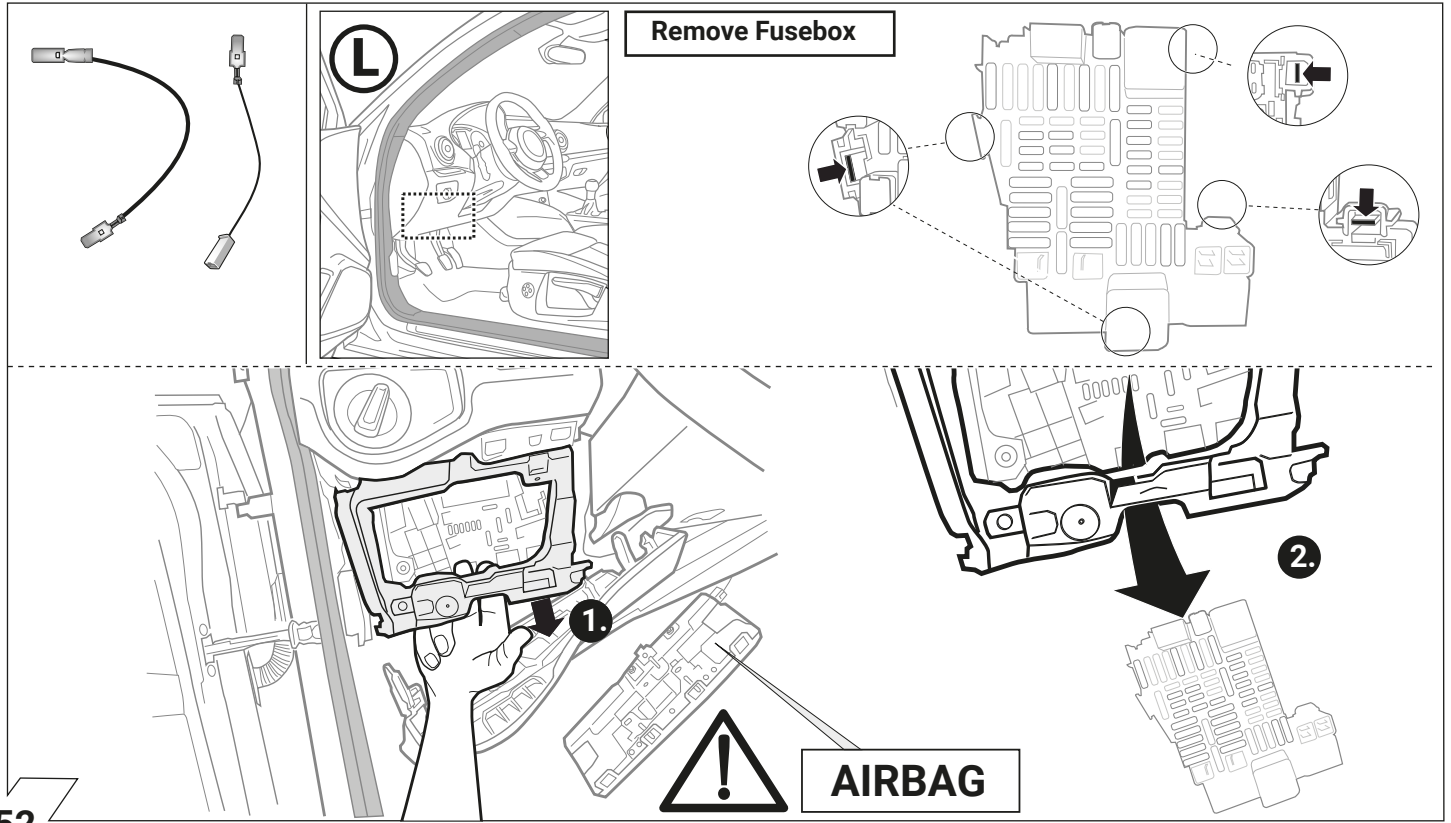

Loccate an unoccupied
plug-in position for the
RD/BK wire!

RD/BK → Pos. 16-20
Pos. 32-36

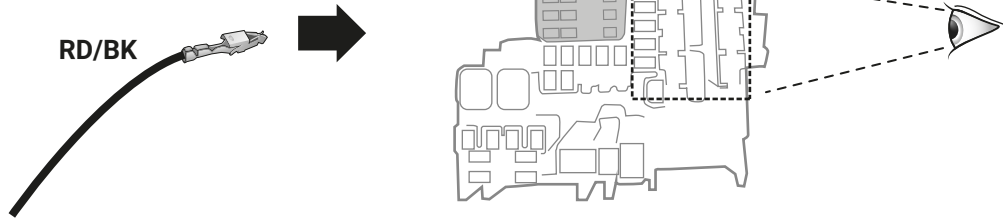

55

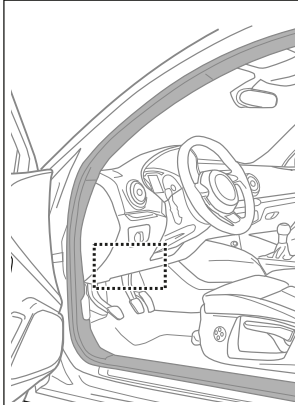

RD/BK = 15A

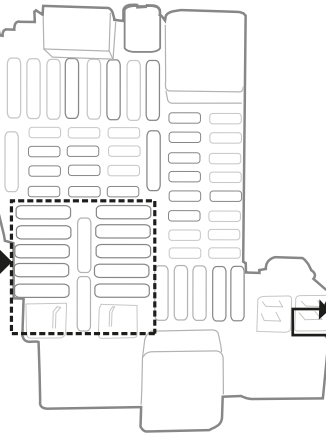

20A

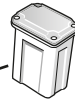

Pos. F61 = 20A



56





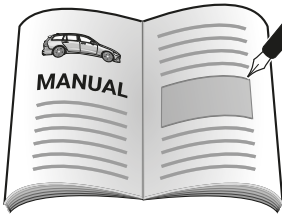







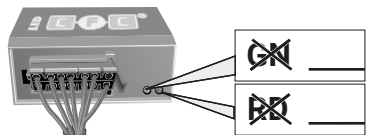



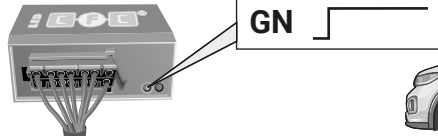

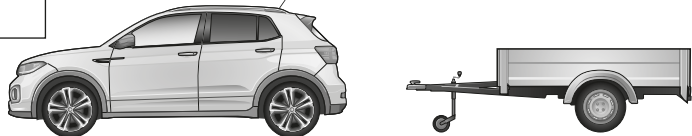

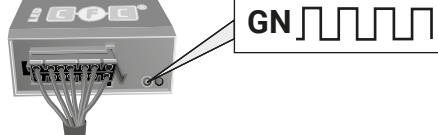
POS.

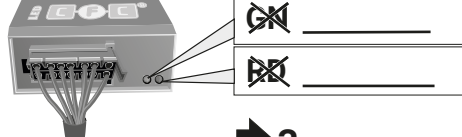
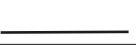
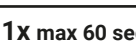
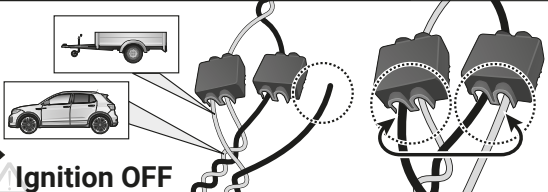
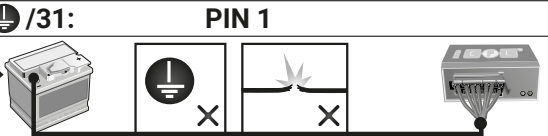

MANUAL

	<p>POS.</p>
<p>30+ 20A</p>	<p>.....</p>

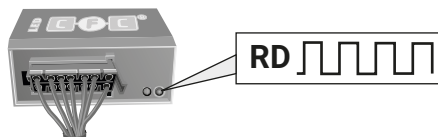
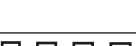
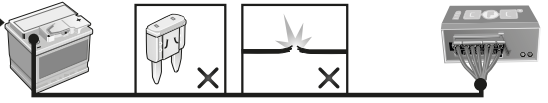
57

D Diagnosefunktion der Kontroll-LED's	GB Diagnosis function of control LEDs	F Fonction diagnostic des LED de contrôle	PL Diagnostyka awarii za pomocą sygnalizacji kontroltek LED
I Funzione di diagnostica dei LED di controllo	E Función de diagnóstico de los LEDs de control	NL Diagnosefunctie van de controle-LED's	SK Diagnostická funkcia kontroltek LED
 <p>Ignition OFF</p>		<p>No CAN-Data =  Standby / Sleepmode</p>	
 <p>Ignition ON</p>	 <p>GN </p>		
 <p>Ignition ON</p>	 <p>GN </p>		
 <p>Ignition ON</p>	 <p>RD </p> <p>3. RD  1x max 60 sec.</p>	<p>CAN-Data Wire PIN 13+14</p>  <p>Ignition OFF</p> <p>OR</p> <p>/31: PIN 1</p> 	 
 <p>Ignition ON</p>	 <p>RD </p>	<p>B+/30: PIN 2 or 4</p> 	
<p>D Blinküberwachung und Leuchten-Substitution bei Ausfall der Anhänger-Blinkleuchten Der Ausfall von einer oder von beiden Anhänger-Blinkleuchten wird je nach Fahrzeugtyp und Ausführung des verbauten Elektro-Einbausatzes wie folgt angezeigt:</p> <ul style="list-style-type: none"> • Erhöhung / Verdoppelung der Blinkfrequenz • Volltextmeldung im Display / Kombi-Instrument • Aktivierung Kontrollleuchte für Lampenausfall • Akustische Warnung via Buzzer oder Voice-Message <p>Bei einem Blinkleuchten-Ausfall ersetzt die gleichseitige Rückleuchte durch Aufleuchten in der Blinkfrequenz eine defekte Anhänger-Blinkleuchte (►Leuchten-Substitution!).</p>	<p>GB Indicator failure detection and lamp substitution if the trailer indicators fail The failure of a single or on both trailer indicators will be shown depending on the type of vehicle and electric kit installed as follows:</p> <ul style="list-style-type: none"> • Increase in the flashing frequency • Text message in the Display / combi-instrument • Activated control lamp for light failure • Audible warning via Buzzer or Voice-Message <p>If an indicator fails the left or right rear light compensates the faulty indicator by flashing at the correct frequency! (►lamp substitution).</p>		
<p>F Surveillance des clignotants et substitution des feux en cas de panne des clignotants de la remorque La panne d'un ou des deux clignotants de la remorque est indiquée de la façon suivante en fonction du type de véhicule et du modèle de module électrique monté:</p> <ul style="list-style-type: none"> • Augmentation / doublement de la fréquence de clignotement • Message complet sur l'affichage / l'instrument combiné • Activation du voyant de contrôle pour panne de lampe • Avertissement sonore via buzzer ou message vocal <p>En cas de panne du clignotant, le feu arrière du côté de la panne remplace un clignotant de remorque défectueux en s'allumant à la même fréquence que le clignotant! (► Substitution des feux!).</p>	<p>I Controllo delle frecce e sostituzione delle lampade in caso di guasto alle frecce del rimorchio A seconda del tipo di veicolo e della versione del kit elettrico montato, il guasto di una o di entrambe le frecce del rimorchio si manifesta come segue:</p> <ul style="list-style-type: none"> • Aumento/raddoppio della frequenza di lampeggiamento • Full text display / strumento combinato • Attivazione della spia di controllo per il guasto lampada • Segnalazione acustica mediante cicalino o messaggio vocale <p>Bij een uitval van (een) knipperlamp(en) vervangt het gelijkzijdige achterlicht door aan te flitsen bij de frequentie del lampeggio la freccia difettosa del rimorchio. (►Sostituzione delle lampade!).</p>		
<p>E Control de intermitentes y sustitución de lámparas en caso de fallo de los intermitentes del remolque El fallo de uno o de ambos intermitentes del remolque se indicará de la siguiente manera en función del tipo del vehículo y de la ejecución del juego de montaje eléctrico montado:</p> <ul style="list-style-type: none"> • Aumento/duplicación de la frecuencia de parpadeo • Mensaje de texto completo en el display/instrumento combinado • Activación de la lámpara piloto para el fallo de lámparas • Advertencia acústica mediante zumbador o mensaje de voz <p>Si hay un fallo de intermitente, la luz trasera del mismo lado reemplazará la lámpara defectuosa del intermitente parpadeando en la misma frecuencia que el intermitente (►Sustitución de lámparas!).</p>	<p>NL Knippercontrole en lampvervanging bij uitval van de knipperlampen van een aanhangwagen De uitval van één of beide knipperlampen van een aanhangwagen wordt afhankelijk van het voertuigtype en de uitvoering van de ingebouwde elektroset als volgt aangegeven:</p> <ul style="list-style-type: none"> • Verhoging / verdubbeling van de knipperfrequentie • Volledige tekstweergave op het display / combi-instrument • Activering controlelampje voor uitval van een lamp • Akoestische waarschuwing via buzzer of Voice-Message <p>Bij een uitval van (een) knipperlamp(en) vervangt het gelijkzijdige achterlicht door aan te flitsen bij de knipperfrequentie een defecte knipperlamp van een aanhangwagen (► Lampvervanging!).</p>		
<p>PL Kontrola kierunkowskazow i zastapienie kierunkowskazow w przyczepie w przypadku awarii. Awaria jednego lub dwóch kierunkowskazow w przyczepie jest sygnalizowana w rozny sposob w zalezności od modelu i wyposazenia samochodu</p> <ul style="list-style-type: none"> • zwiekszenie częstotliwości migania kierunkowskazow • komunikatem na desce rozdzielczej • aktywacja kontroli awarii swiateł • dźwiękowa sygnalizacja lub komunikat głosów <p>Przypadku awarii kierunkowskazow światło cofania zastąpi kierunkowskaz po tej samej stronie kierunkowskazow światło cofania zastąpi kierunkowskaz po tej samej stronie</p>	<p>SK Kontrola smerových svetiel a náhrada svetiel pri vypadku smerového svetla privesu Vypadok jedného alebo oboch smerových svetiel privesu je v závislosti od typu vozidla a verzie elektrosady indikovaný nasledovne:</p> <ul style="list-style-type: none"> • zvýšenie / zdvojnásobenie frekvencie blikania • textová správa na displeji / kombinovanom nastroji palubnej dosky • aktivácia kontroltek vypadku svetla • akustická výstraha prostredníctvom bzuciaka alebo hlasovej spravy <p>Pri vypadku smerového svetla nahradí blikaajúce spätné svetlo tej istej strany nefunkčné smerové svetlo privesu (►náhrada svetiel)</p>		

	D	ERKLÄRUNG SYMBOLE	GB	SYMBOL EXPLANATION	F	EXPLICATION DES SYMBOLES	I	SPIEGAZIONE DEI SIMBOLI	ES	EXPLICACIÓN DE LOS SIMBOLES	NL	VERKLARING SYMBOLEN	PL	OBJASNIENIA SYMBOŁI	SK	VYSVETLIVKY K SYMBOLOM		
	linke (58-L) bzw. rechte (58-R) Schlussleuchte		left (58-L) respectively right (58-R) tail light	feu arrière gauche (58-L) respectivement droite (58-R)	luzce posteriora sinistra (58-L) respectivamente destra (58-R)	piłato trasero izquierdo (58-L) respectivamente derecho (58-R)	Linker (58-L) c.q. rechter (58-R) achterlicht	Lewe (58-L) lub prawe (58-R) koncowe swiatlo	Lavé (58-L) resp. pravé (58-R) koncové svetlá									
	Bremsleuchte (54) 3. Bremsleuchte (54)		stop light (54) high mounted, third stop light (54)	feu de stop (54) 3ième feu de stop (54)	luz de freno (54) tercera luz de freno (54)	Remlicht (54) 3e remlicht (54)	Światło stop (54) trzecie światło stop (54)	Brzdové svetlá (54) tretie brzdové svetlo (54)										
	Fahrtrichtungsanzeiger links		turn signal indicator left	feu indicateur de direction gauche	luz indicadora de dirección de marcha izquierda	Richtingaanwijzer links	Kierunkowskaz lewy	Smerové svetlo ľavé										
	Fahrtrichtungsanzeiger rechts		turn signal indicator right	feu indicateur de direction droite	luz indicadora de dirección de marcha derecha	Richtingaanwijzer rechts	Kierunkowskaz prawy	Smerové svetlo pravé										
	Nebelschlussleuchte(n)		rear fog light(s)	feu (x) arrière (s) de brouillard	fendinebbia		Mistachterlicht(en)	Hmlivové svetlo(á)										
	Rückfahrleuchte(n)		reversing light(s)	feu (x) de marche arrière	luce (l) retromarcia		Achteruitrijlicht(en)	Spätne svetlo (á)										
	Dauerstrom / Steckdose 13P Kammer 9		Permanent power supply / 13pin socket, chamber 9	courant continue / prise de courant à 13 pôles, compartiment 9	alimentazione continua / presa 13 poli, camera 9		Continuustroom / stekkerdoos 13P Kamer 9	Trvale plus/gniazdo 13 biegunowe, kontakt 9										
	Ladeführung / Steckdose 13P Kammer 10		charging wire for trailer battery / 13pin socket, chamber 10	cable de charge / prise de courant à 13 pôles, compartiment 10	cavo di carica / presa 13 poli, camera 10		Laadraad / stekkerdoos 13P kamer 10	przewód ładowczy/gniazdo 13 biegunowe, kontakt 10										
	Anhängerkennung		trailer recognition	détection de la fonction "remorque"	rimorchio / riconoscimento rimorchio		Aanhanger / aanhangeridentificatie	Prives / rozpoznanie przyczepy										
	Dauerstrom/ permanente Stromversorgung		Permanent current power supply	courant continue / alimentation électrique permanente	corrente / alimentazione continua		Continuustroom / permanente stroomvoorziening	Trvale plus / stały prąd prądu										
	Masse (31)		Ground or Earth (31)	masse (31)	masa (31)		Massa (31)	Ukostrzenie (31)										
	Batteriepolklemme Anschluss Minus		ground connection battery terminal lug	borne "moins" de la batterie	connessione negativa della batteria		Accupoolklem aansluiting min	Svorka baterie - minus										
	Batteriepolklemme Anschluss Plus		positive connection battery terminal lug	borne "plus" de la batterie	connessione positiva della batteria		Accupoolklem aansluiting plus	Svorka baterie - plus										
	Sicherung / Sicherungsstärke 20 Ampère		fuse / fuse capacity 20 Ampère	fusible / ampérage 20 ampères	fusibile / capacità 20 Ampère		Zekering / zekeringssterkte 20 Ampère	Poistka / Výkon poistky 20 Amper										
	Zigarettenanzünder / Zubehör-Steckdose		cigarette lighter / accessory socket	allume-cigare / prise d'accessoires	accendisigari / presa accessori		Sigarettenaansteker / accessoires stekkerdoos	Zapalniczka / gniazdo uzupełniające										
	Lautsprecher / Warnummer		loudspeaker / buzzer	haut-parleur / vibreux	auto parlante / cicalino		Luidspreker / waarschuwingszoeimer	klakson										
	Einparkhilfe		park distance control	assistance au parking	sensori di parcheggio		Inparkeerhulp	Parkovací senzor										
	Schalter / Funktionsursprung		switch / source of function	interrupteur / origine de fonction	interruttore / origine funzione		Schakelaar / functieoorsprong	Przełącznik										
	verbinden		Connect together	raccorder	connessione		Koppelen	połączyć										
	trennen		disconnect	séparer	sconnessione		Ontkoppelen	rozłączyć										
	beachten / siehe weitere Informationen		Look at / see further information	considérer / voir informations ultérieures	considerare / vedere ulteriori informazioni		Let op / bekijk verdere informatie	Sledzić / patrz następane informacje										
	beachte auserwählten Bereich		look carefully at selected area	faire attention à la zone sélectionnée	considerare area selezionata		Let op gekozen bereik	Sledzić/wybrana część										
	vorhanden / belegt / i.o.		Present / Occupied / OK	disponible / occupé / OK	presente / occupato / OK		Aanwezig / bezet / i.o.	Nachádzajú sa / osadený / v poriadku										
	nicht vorhanden / nicht belegt / nicht i.o.		Not present / Not occupied / not OK	pas disponible / pas occupé / pas OK	non presente / non occupato / non OK		Niet aanwezig / niet bezet / niet i.o.	Nenachádzajú sa / neosadený / nie je v poriadku										
	links		left	gauche	sinistra		Links	na lewo										
	rechts		right	droite	destra		Rechts	na prawo										
	Akustische Signalisierung		acoustic indication	signalisation acoustique	segnalazione acustica		Akoestische signalering	dźwiękowa sygnalizacja										
	Achtung / wichtiger Hinweis		attention / important advice	attention / indication importante	attenzione / indicazione importante		Attentie / belangrijke instructie	Uwaga / ważna informacja										