

## Fiat Fiorino / Peugeot Bipper / Citroën Nemo

Partnr.: FI-024-DH

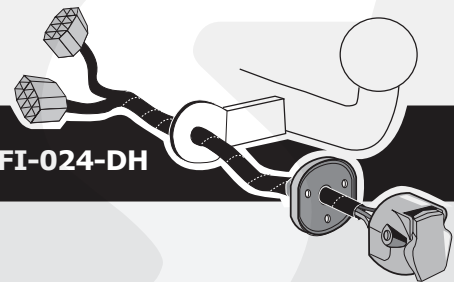

**DE** Einbauanleitung Elektrosatz Anhängervorrichtung mit 13-P Steckdose lt. DIN/ISO Norm 11446

**FR** Instructions de montage du faisceau électrique pour crochet d'attelage conforme à la norme DIN/ISO 11446 prise 13-V.

**NL** Montage-handleiding elektrokabelset voor trekhaak met 13-P contactdoos vlg. DIN/ISO norm 11446.

**GB** Fitting instructions electric wiring kit tow bar with 13-P socket up to DIN/ISO Norm 11446.

**ES** Instrucciones de montaje de kit eléctrico para enganche de remolque con caja de conexiones 13-P según norma DIN/ISO 11446.

**IT** Istruzioni di montaggio di set di cavi elettrici per gancio da traino con zoccolo a 13-P conforme alla norma DIN/ISO 11446.

**SE** Monteringsanvisningar elkabelsats för dragkrok med 13-P kontaktdosa enligt DIN/ISO norm 11446.

**CZ** Montážní pokyny: souprava pro elektrické propojení tažné tyče s 13-P zásuvkou do normy DIN/ISO 11446.

**DK** Monteringsvejledninger for det elektriske ledningsføringssæt for trækstang med 13-N stikdåse, DIN/ISO, norm 11446.

**FI** Ohjeet vetokoukun sähkökaapelisarjan asentamiseen, jossa on DIN/ISO 11446 mukainen 13-N liitin.

**GR** Οδηγίες συναρμολόγησης ηλεκτρικού σετ καλωδίων μπάρας ρυμούλκησης με υποδοχή 13-P μέχρι DIN/ISO Κανόνας 11446.

**NO** Monteringsanviser elkabelsett for trekrok med 13-P koblingsboks ifølge DIN/ISO norm 11446.

**PL** Instrukcje montażu zestawu okablowania elektrycznego dyszla holowniczego z 13-stykowym gniazdem DIN/ISO 11446.

**DE** - Wir weisen ausdrücklich darauf hin, dass eine unsachgemäße und nicht in einer Fachwerkstatt durchgeführte Montage einen Verzicht auf Entschädigung jeglicher Art insbesondere bezüglich des Produkthaftpflichtrechts zur Folge hat

**FR** - Il est expressément prévu qu' on ne saurait se prévaloir d'un quelconque préjudice contractuel ou rédhibitoire si le montage avait été fait en dépit des dites instructions ou dans un garage ne disposant pas des équipements adéquats.

**NL** - Wij wijzen er met nadruk op, dat ondeskundige en niet door een vakkundige werkplaats uitgevoerde montage tot gevolg heeft dat daardoor ieder recht op schadevergoeding, ook op wettelijke aansprakelijkheid inzake producten, vervalt.

**GB** - We would expressly point out that assembly not carried out properly by a competent installer will result in cancellation of any right to damage compensation, in particular those arising by virtue of the product liability act.

**ES** - El montaje inapropiado y efectuado por personal no cualificado originará la pérdida de todo derecho a indemnización o la expiración de toda responsabilidad civil con respecto al producto.

**IT** - Sottolineiamo espressamente che un montaggio inadeguato ed eseguito da un'officina non specializzata ha come conseguenza il decadere di qualsiasi diritto al risarcimento danni, nonché alla responsabilità legale relativa ai prodotti.

**SE** - Vi påpekar med eftertryck att all rätt till skadeersättning och all laglig ansvarighet förfaller om monteringen inte har utförts på rätt sätt och av en professionell verkstad.

**CZ** - Výslovně zdůrazňujeme, že jakákoli montáž, která není provedená ve specializované dílně, má za následek odvolání nároků na kompenzaci jakéhokoliv druhu, obzvláště vyplývajících ze zákona o odpovědnosti za způsobené škody.

**DK** - Vi ønsker at gøre udtrykkeligt opmærksom på at forkert samling, der ikke er udført af et specialiseret værksted, resulterer i bortfaldelse af kompenseringskrav af alle slags, i særdeles krav der måtte opstå omkring det lovpligtige ansvar.

**FI** - Korostamme, että kaikki oikeudet vahinkokorvaukseen kuten myös valmistajan laillinen vastuu raukeavat, mikäli asennusta ei ole toteutettu oikealla tavalla eikä ammattitaitoisen asiantuntijan toimesta.

**GR** - Επισημαίνουμε κατηγορηματικά ότι οποιαδήποτε εσφαλμένη συναρμολόγηση, η οποία δεν έχει πραγματοποιηθεί ειδικό εργαστήριο θα οδηγήσει σε απονοίηση των αξιώσεων επιβόλης αποζημιώσεων οποιαδήποτε είδους, ειδικά όσα προκύπτουν από το νόμο ευθύνης προϊόντων.

**NO** - Vi påpeker ettertrykkelig at all rett til skadeerstatning og rettslig ansvar forfaller dersom monteringen ikke er blitt utført på riktig måte og av et profesjonelt verksted.

**PL** - Chcielibyśmy wyraźnie zaznaczyć, iż wszelki nieprawidłowy montaż, który nie jest wykonywany w specjalistycznym warsztacie pociąga za sobą utratę możliwości dochodzenia wszelkiego typu roszczeń, w szczególności tych wynikających z odpowiedzialności producenta za swój produkt.

- Technische Änderungen vorbehalten.

- Widerstand nur gemäß der Tabelle auf dem Anhänger verwenden, siehe Seite 13.

- Sous réserve de modifications techniques.

- Ne excédez pas la charge maximale, indiquée dans le tableau sur page 13.

- Technische wijzigingen voorbehouden.

- Gebruik alleen belasting volgens aansluittabel op het getrokken voertuig, zie pagina 13.

- Contents of these kits and their fitting manuals are subject to alteration without notice, please ensure that these instructions are read and fully understood before commencing installation.

- Do not overload circuits; the maximum loads per connection are detailed in this manual.

- Nos reservamos el derecho a efectuar modificaciones técnicas.

- Utilice sólo cargas de acuerdo a la tabla de conexión del vehículo remolcado (ver página 13).

- Ci si riserva il diritto di apportare modifiche tecniche.

- Utilizzare esclusivamente un carico conforme alla tabella degli allacci relativa al veicolo in questione, cfr. pagina 13.

- Tekniska ändringar förbehålles.

- Använd endast belastning enligt anslutningstabellen på det dragna fordonet, se sid. 13.

- Změny mohou být provedeny bez oznámení.

- Používejte pouze při maximálním nabití podle tabulky na tažném vozidle, viz. str. 13.

- Kan ændres uden varsel.

- Brug kun den maksimale belastning, i overensstemmelse med forbindelsestabelen for bugserede køretøjer, side 13.

- Oikeus teknisiin muutoksiin ilman erillistä huomautusta pidätetään.

- Kuormita työvirtapiiriä ainoastaan hinattavan ajoneuvon kytkentäkaavion mukaisesti, katso sivu 13.

- Μπορεί να τροποποιηθεί χωρίς προηγούμενη ειδοποίηση.

- Χρησιμοποιείτε μόνο μέγιστο ηλεκτρικό φορτίο σύμφωνα με τον πίνακα σύνδεσης στο ρυμούλκούμενο όχημα, δείτε σελίδα 13.

- Tekniske endringer forbeholdes. - Overskrid ikke grensene anvist i tilkoblingstabellen på tilhengeren eller det tilkoblede kjøretøyet, se s. 13.

- Podlega zmianom bez powiadomienia.

- Używać tylko takiego maksymalnego obciążenia które wynika z tabliczki połączeń holowanego pojazdu, patrz strona 13.

Einzelteilliste

Liste de pièces

Onderdelenlijst

Part list

Lista de componentes

Elenco componenti

Dellista

Seznam dílů

Del-liste

Osaluettelo

Κατάλογος εξαρτημάτων

Delliste

Lista części

DE

FR

NL

GB

ES

IT

SE

CZ

DK

FI

GR

NO

PL

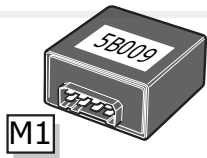
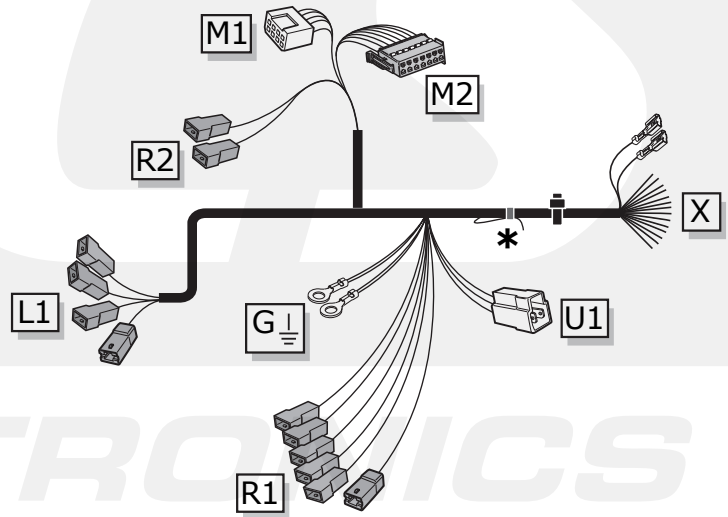
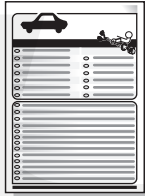
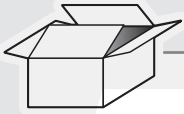

L.E.D.

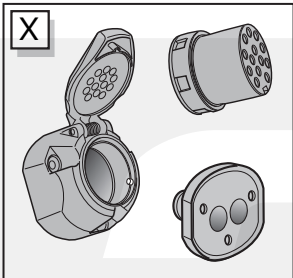
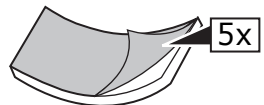

4x

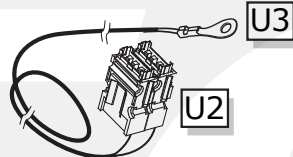

15x

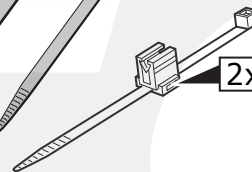

2x

**\* Option!**

**Pag. 12**

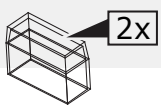
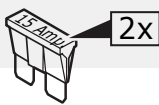
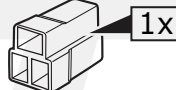
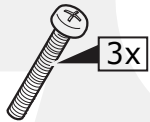

ELECTRONICS

**ROUTING**

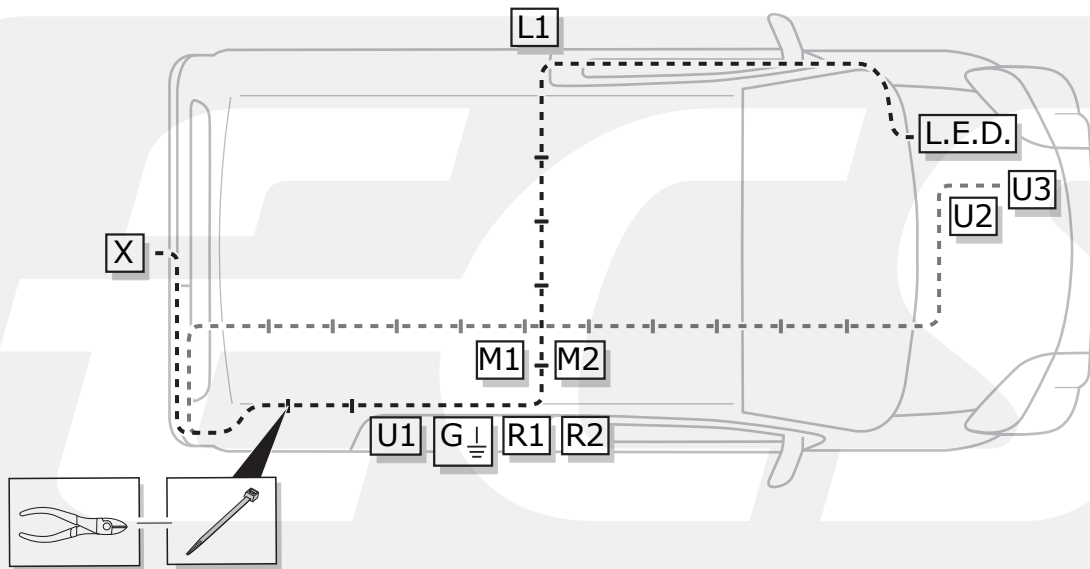

**1**

2x

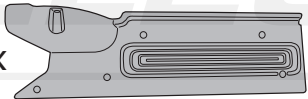

**1**

2x

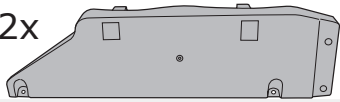

**2**

**3**

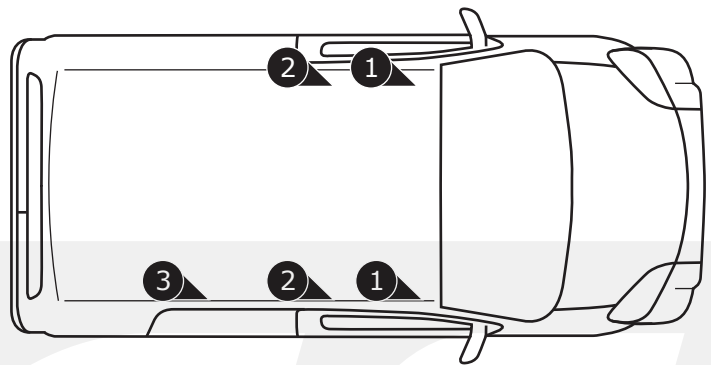
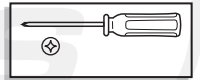
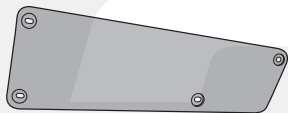

**2**

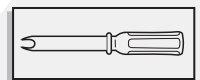
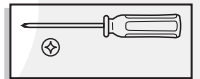
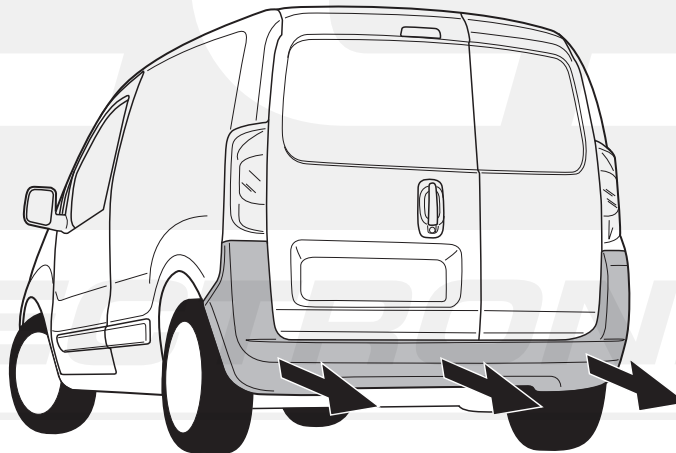

# COLOR TABLE

	(DE)	(FR)	(GB)	(NL)	(ES)	(IT)	(SE)	(CZ)	(DK)	(FI)	(GR)	(NO)	(PL)
BU	Blau	Bleu	Blue	Blauw	Azul	Blu	Blå	Modrá	Blå	Sininen	Μπλε	Blå	Niebieska
BK	Schwarz	Noir	Black	Zwart	Negro	Nero	Svart	Černá	Sort	Musta	Μαύο	Sort	Czarna
BN	Braun	Marron	Brown	Bruin	Marrón	Marrone	Brun	Hnědá	Brun	Ruskea	Καφέ	Brun	Brązowa
GN	Grün	Vert	Green	Groen	Verde	Verde	Grön	Zelená	Grøn	Vihreä	Πράσινο	Grønn	Zielona
GY	Grau	Gris	Grey	Grijs	Gris	Grigio	Grå	Šeda	Grå	Harmaa	Γκρι	Grå	Szara
OG	Orange	Orange	Orange	Oranje	Naranja	Arançione	Orange	Oranžová	Orange	Oransi	Πορτοκάλι	Orange	Pomarańczowa
RD	Rot	Rouge	Red	Rood	Rojo	Rosso	Röd	Červená	Rød	Punainen	Κόκκινο	Rød	Czerwona
WH	Weiß	Blanc	White	Wit	Blanco	Bianco	Vit	Bílá	Hvid	Valkoinen	Λευκό	Hvít	Biała
YE	Gelb	Jaune	Yellow	Geel	Amarillo	Giallo	Gul	Žlutá	Gul	Keltainen	Κίτρινο	Gul	Żółta
PK	Rosa	Rose	Pink	Rosé	Rosa	Rosa	Rosa	Růžová	Rosa	Rosa	Ροζ	Rosa	Różowa
PE	Purpur	Pourpre	Purple	Paars	Púrpura	Rosso porpora	Purper	Purpurov	Purper	Purppura	Πορφυρό	Purper	Purpurowa
DL	Dunkelblau	Bleu foncé	Dark blue	Donkerblauw	Azul oscuro	Blu scuro	Mörkblå	Tmavomodrá	Mørkeblå	Tummansininen	Σκούρο μπλε	Mørkeblå	Granatowa
DG	Dunkelgrün	Vert foncé	Dark green	Donkergroen	Verde oscuro	Verde scuro	Mörkgrön	Tmavozelená	Mørkegrøn	Tummanvihreä	Σκούρο πράσινο	Mørkegrønn	Ciemnozielona
LB	Hellblau	Bleu clair	Light blue	Lichtblauw	Azul claro	Blu chiaro	Ljusblå	Bleděmodrá	Lyseblå	Vaaleansininen	Ανοιχτό μπλε	Lyseblå	Jasnoniebieska
LG	Hellgrün	Vert clair	Light green	Lichtgroen	Verde claro	Verde chiaro	Ljusgrön	Světlezelená	Lysegrøn	Vaaleanvihreä	Ανοιχτό πράσινο	Lysegrønn	Jasnozielona
NL	Naturfarben	Nature	Natural colour	Naturel	Color natural	Colori naturali	Naturfärger	Přírodní	Naturfarvet	Luonnonväri	Φυσικά χρώματα	Naturfarger	Barwy
SB	Himmelblau	Bleu ciel	Sky blue	Hemelsblauw	Azul cielo	Celeste	Himmelsblå	Blankytná	Himmelblå	Taivaansininen	Γαλάζιο	Himmelblå	Błękitna
T	Gelbbraun	Marron-jaune	Yellow brown	Geelbruin	Amarillo-marrón	Giallomarrone	Gulbrun	Žlutohnědá	Gulbrun	Keltaisennuskea	Κίτρινοκαφέ	Gulbrun	Żółtobrązowa
VT	Violett	Violet	Violet	Violet	Violeta	Viola	Violett	Fialová	Violet	Violetti	Μοβ	Fiolett	Fioletowa

3

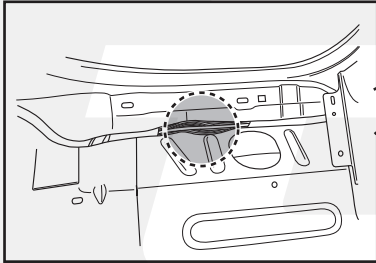
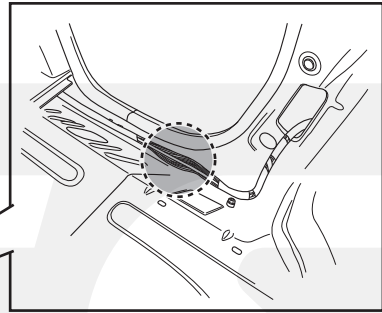
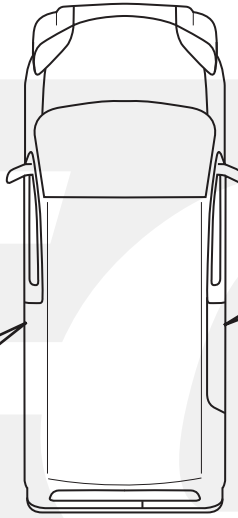
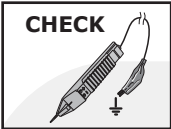

58R		
R		
54		
Reverse		

58L		
L		

54G		
-----	--	--

54G		
-----	--	--

4

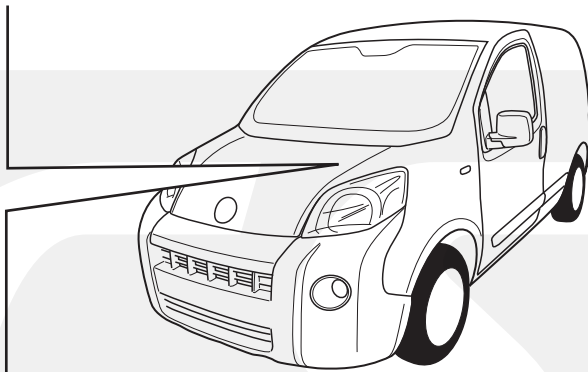
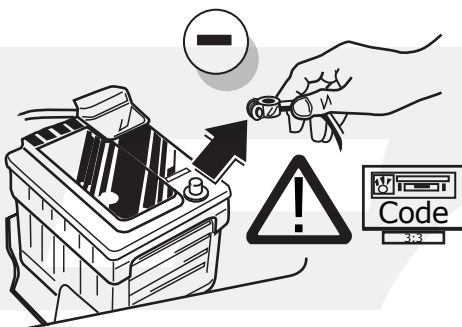

5

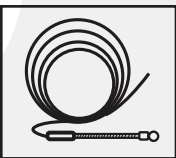
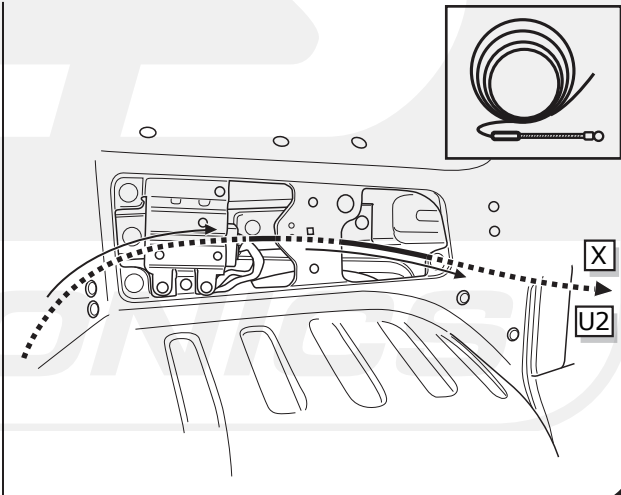
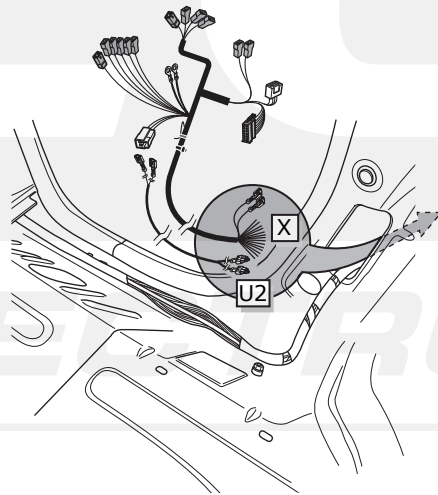
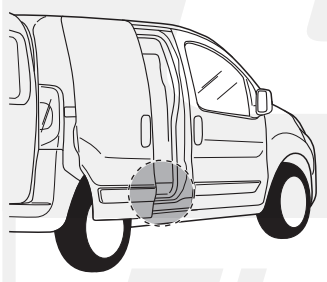

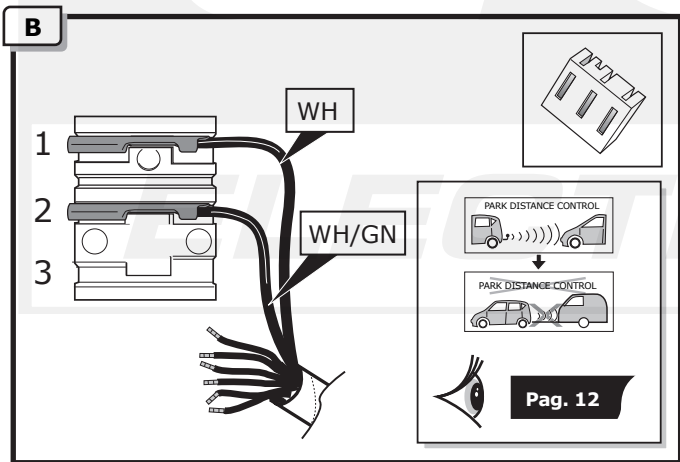
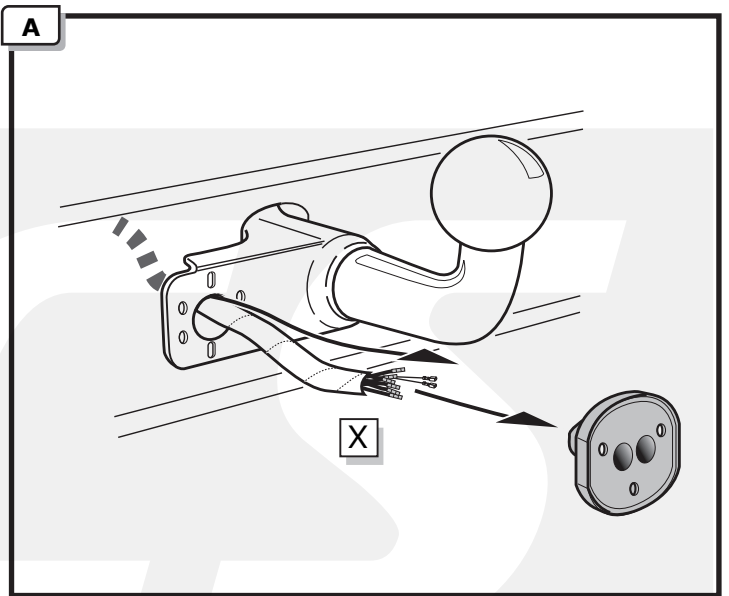
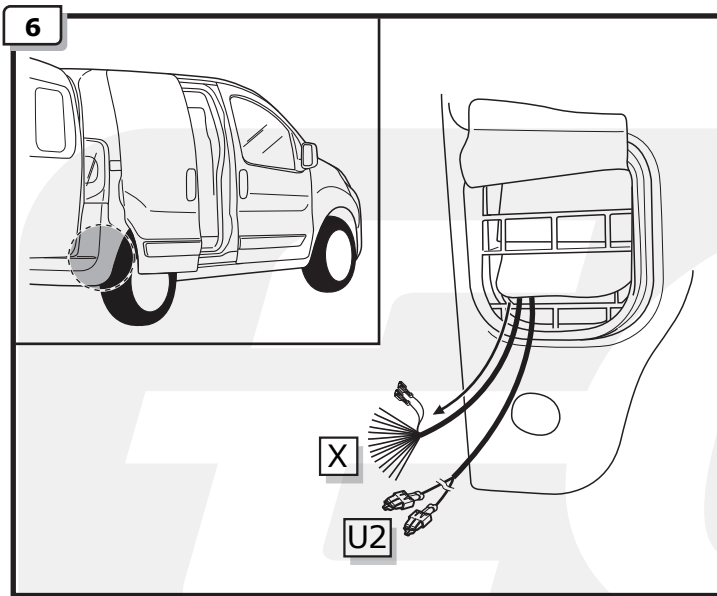

**INFO**

(DE) Anschluss Steckdose	(CZ) Objímkový konektor
(FR) Connection de la prise	(DK) Stikdåse forbindelse
(NL) Contactdoos aansluiting	(FI) Pistorasia liitäntä
(GB) Socket connection	(GR) Υποδοχή σύνδεσης
(ES) Conexión de la caja de enchufe	(NO) Tilkobling koblingsboks
(IT) Allaccio zoccolo	(PL) Połączenie przez gniazdo
(SE) Anslutning kontaktdosa	

Pag. 13

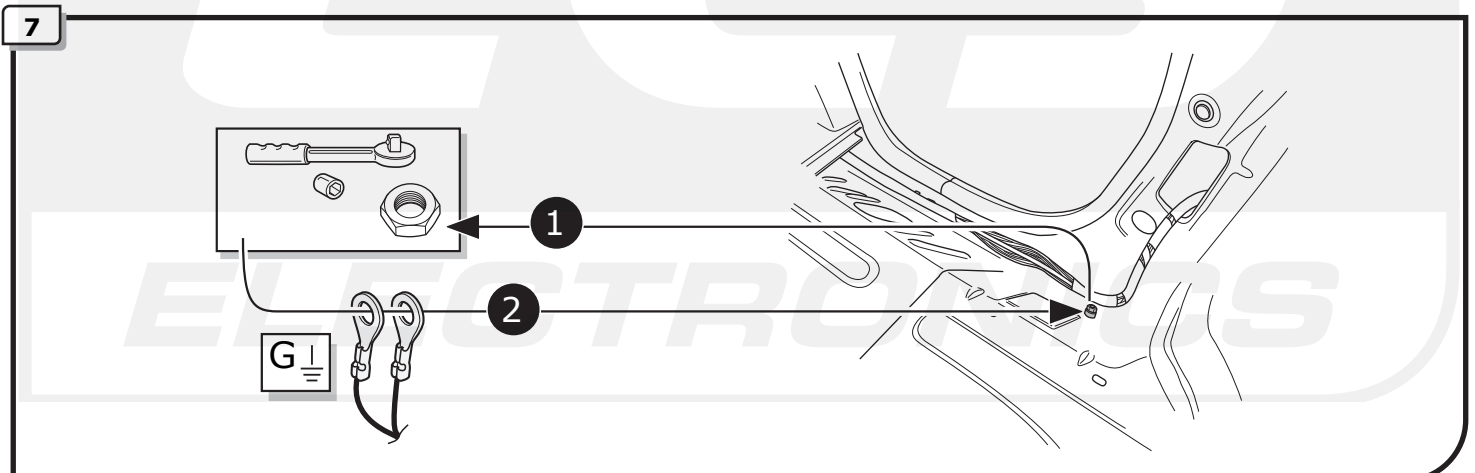
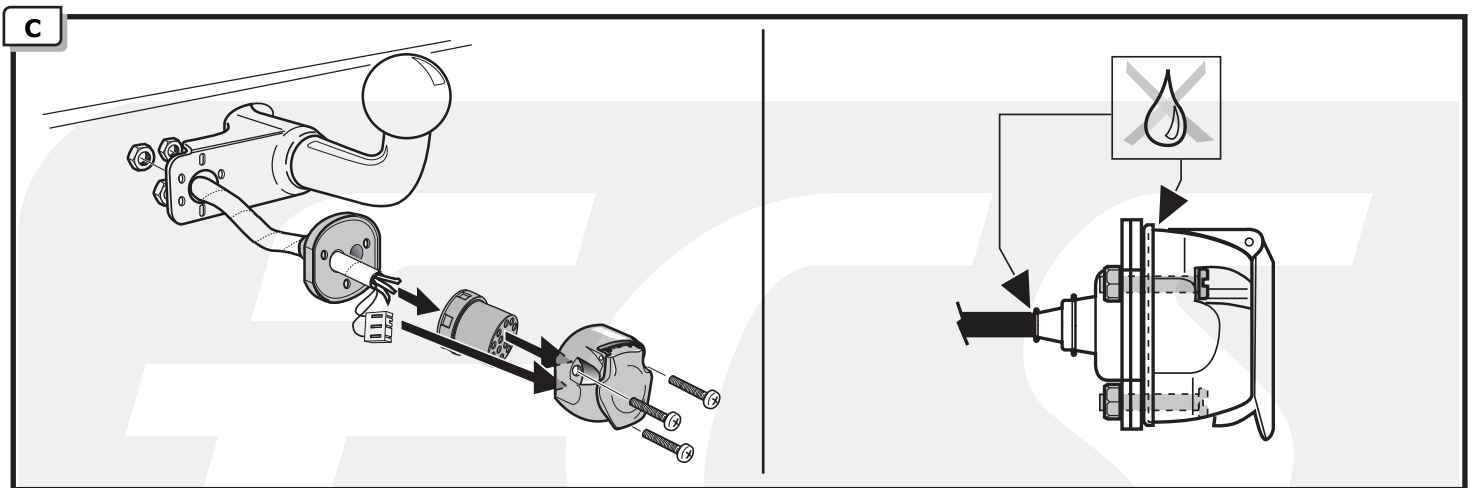

8

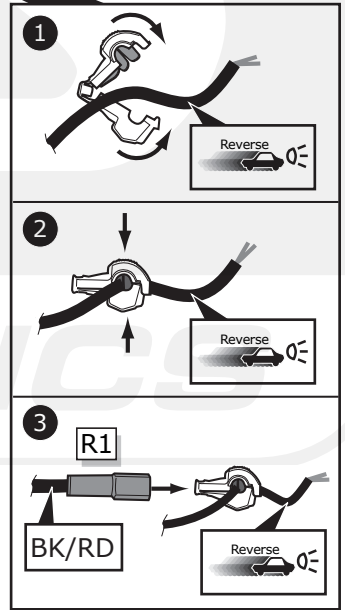
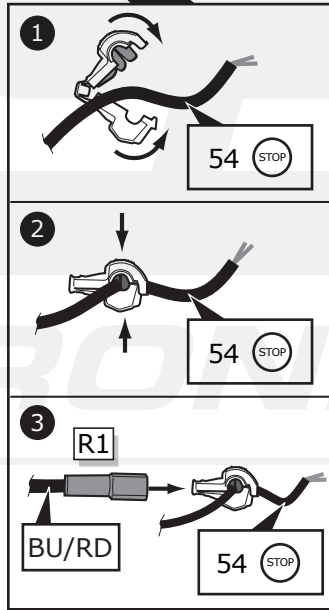
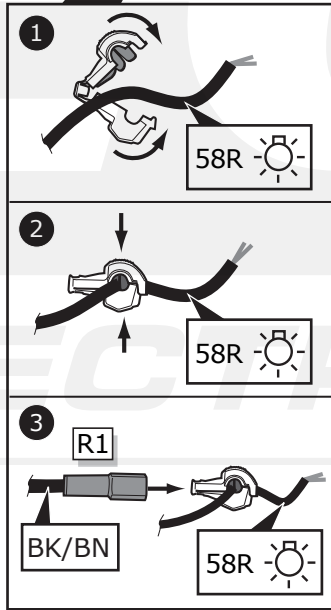
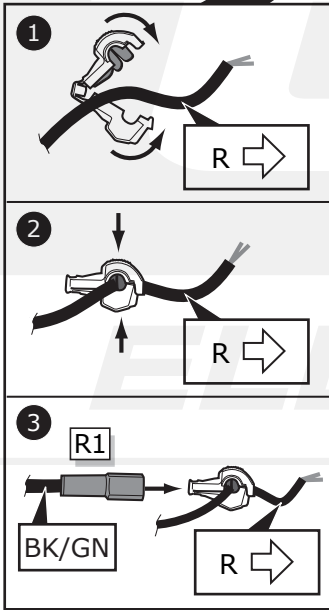
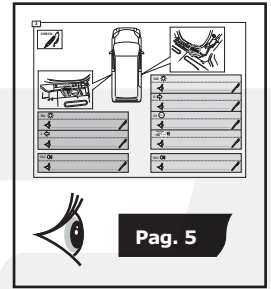
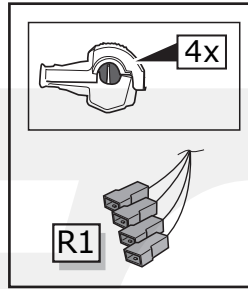
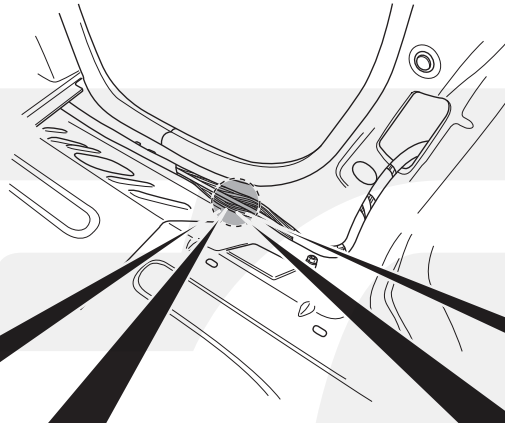
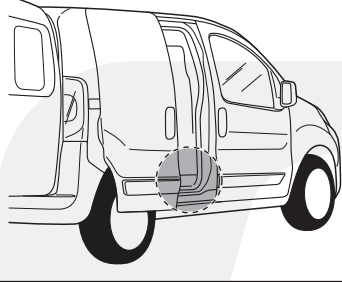

9

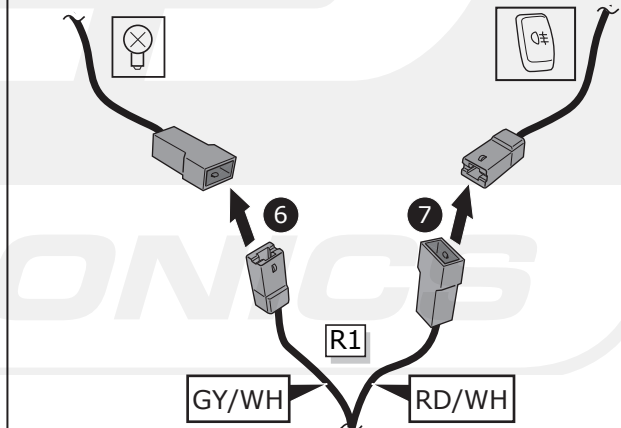
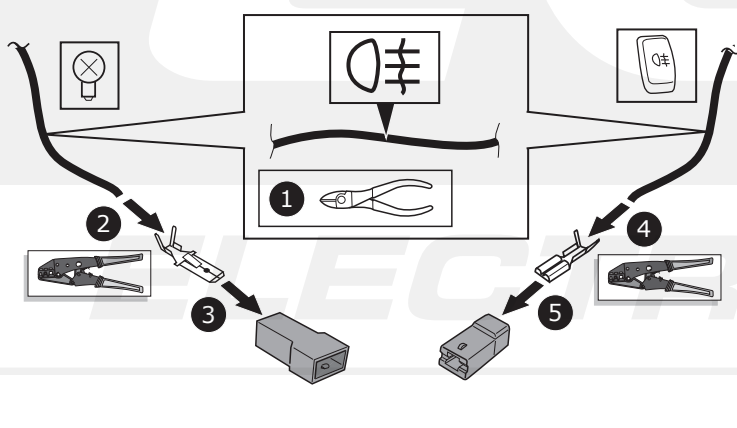
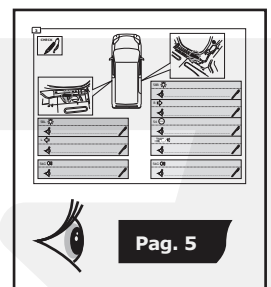
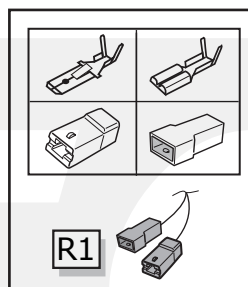
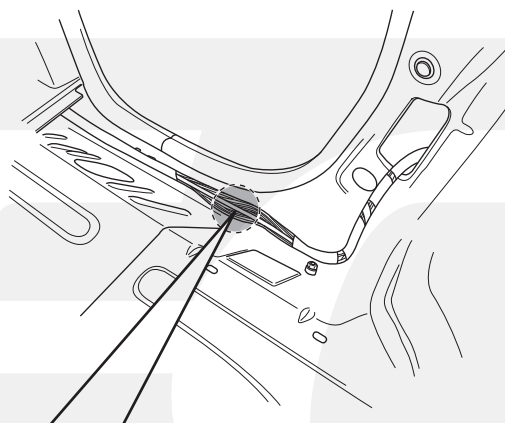
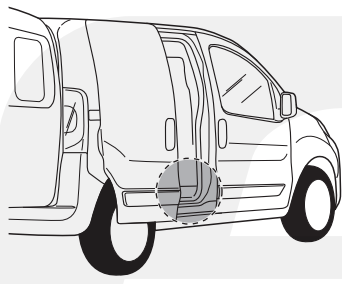

10

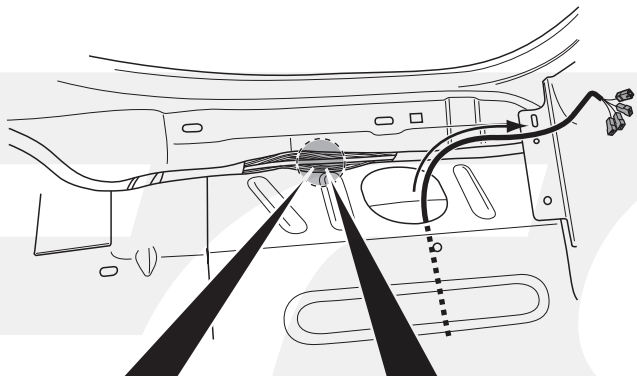
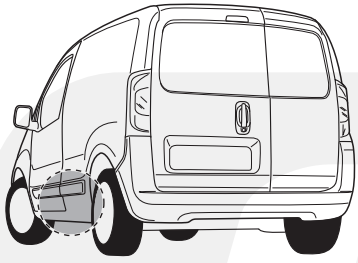

1	1
2	2
3	3
4	4
4	4
4	4

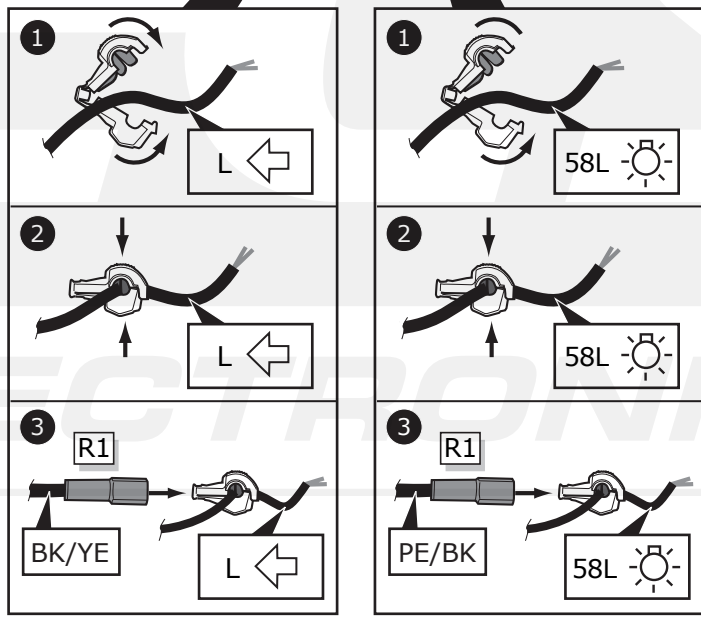
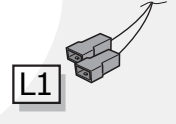
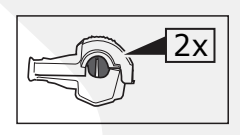

11

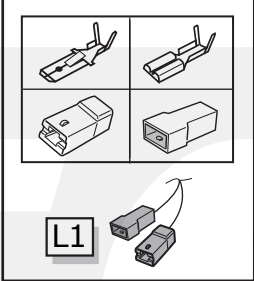
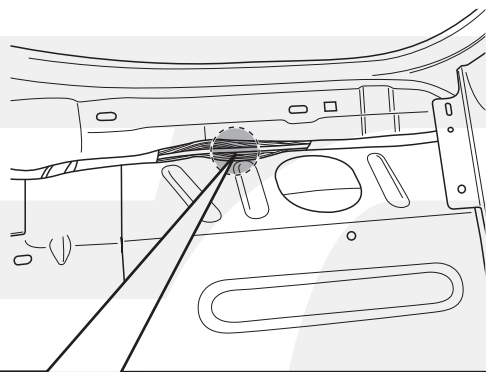
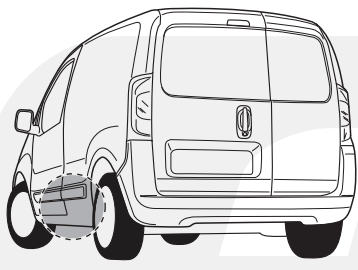

1	1
2	2
3	3
4	4
4	4
4	4

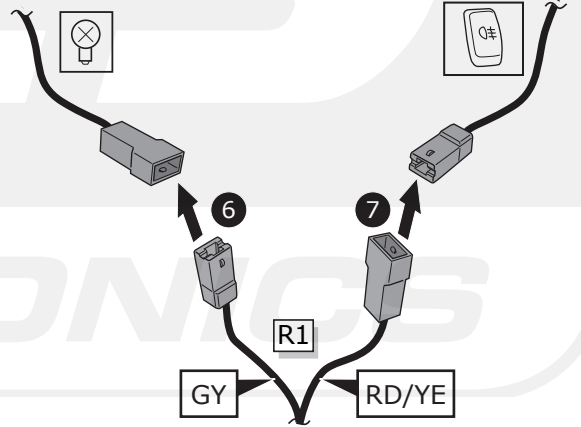
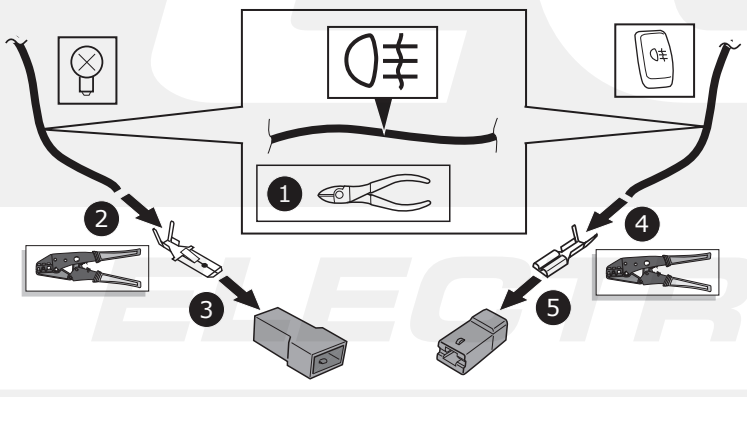
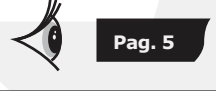



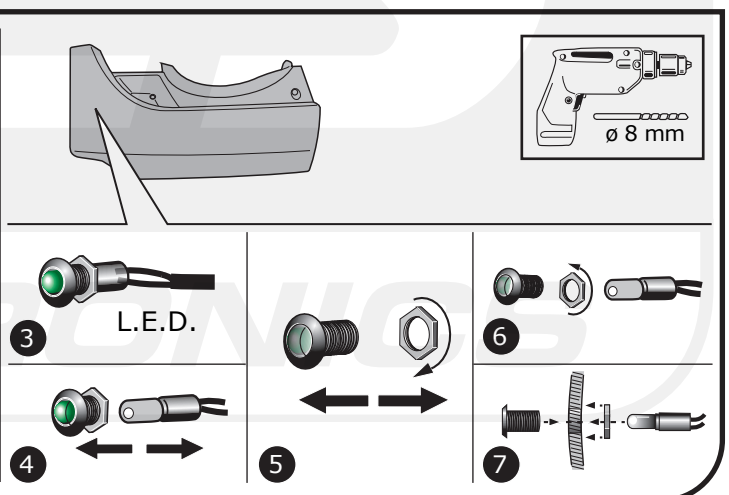
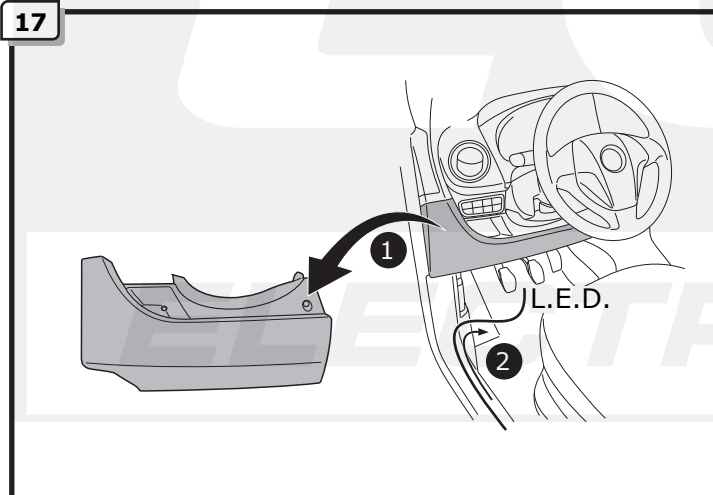
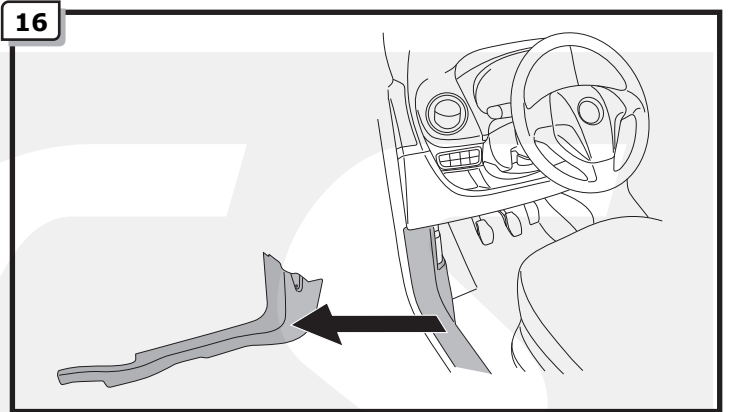
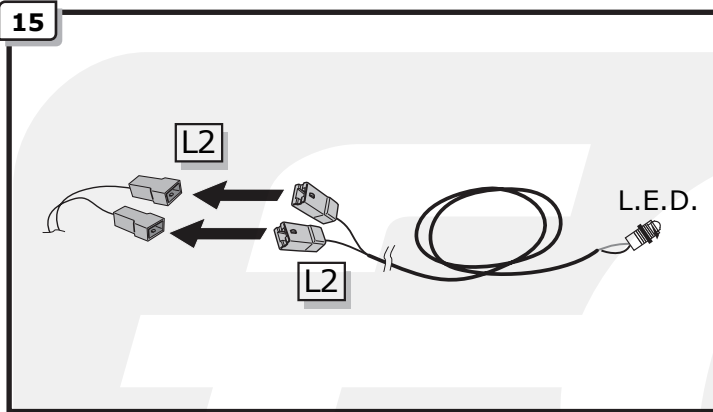
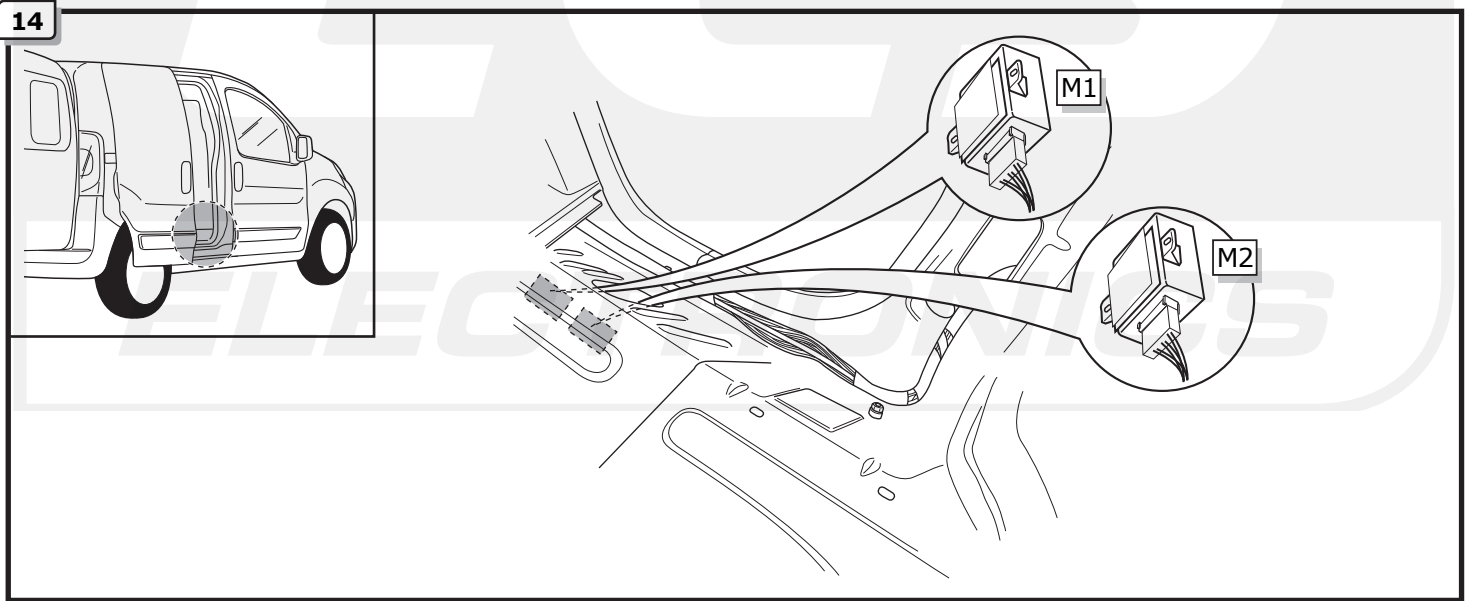
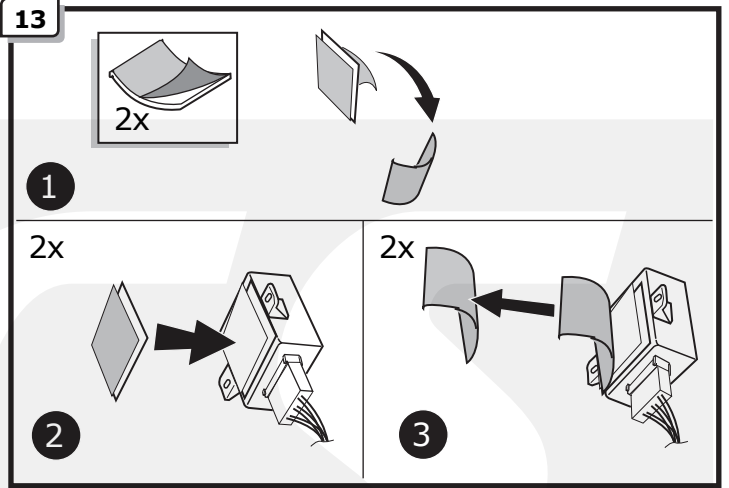
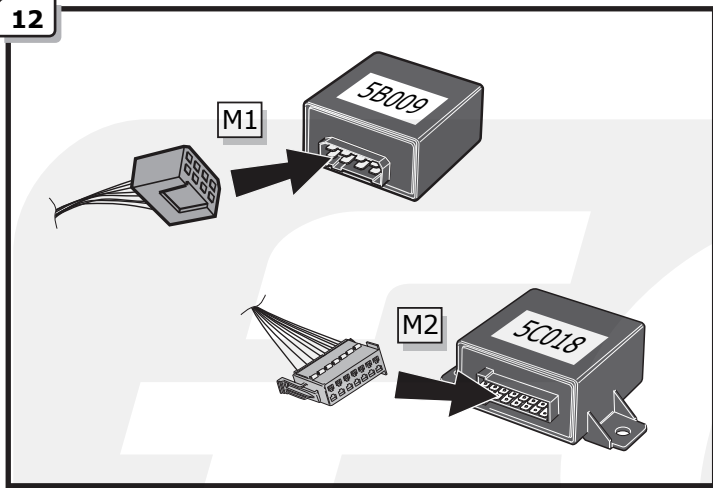

18

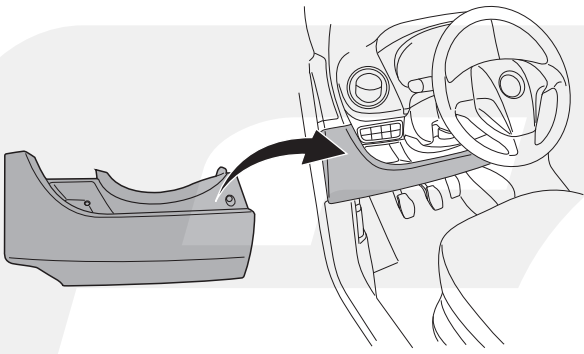

19

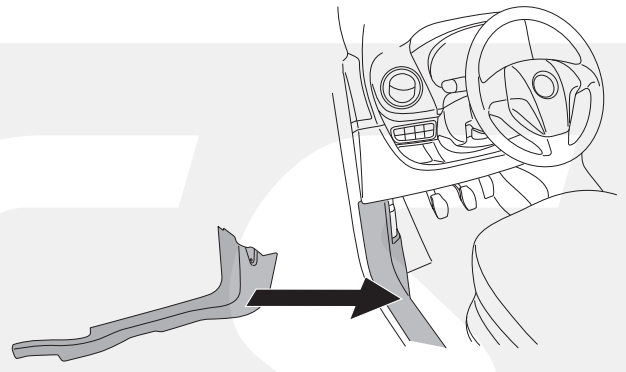

20

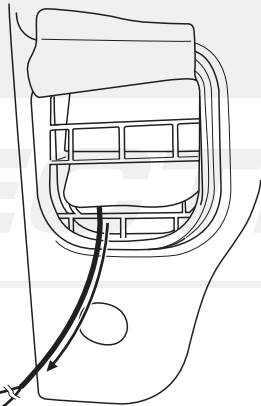
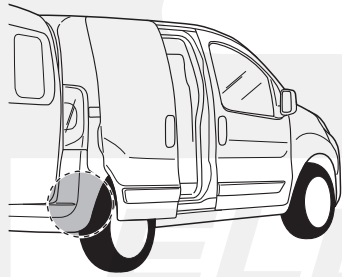

U2

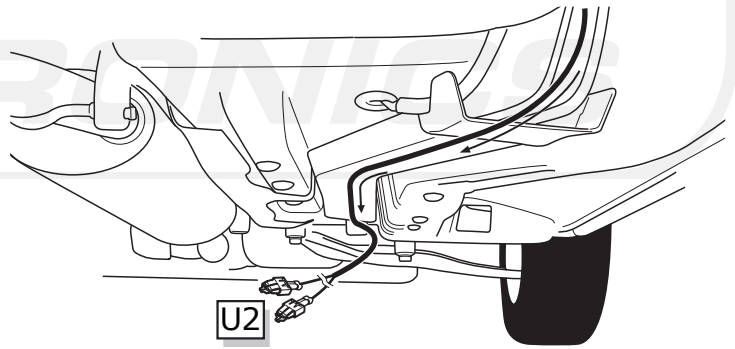

U2

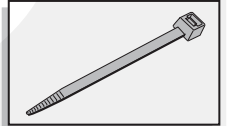

21

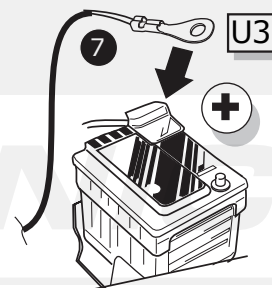
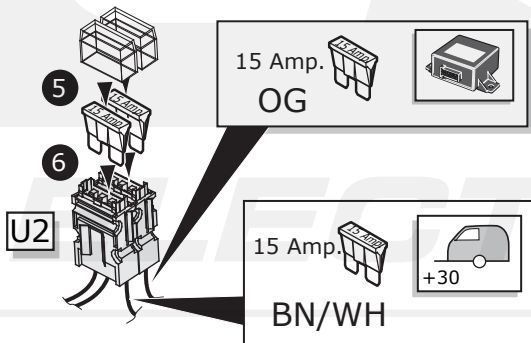
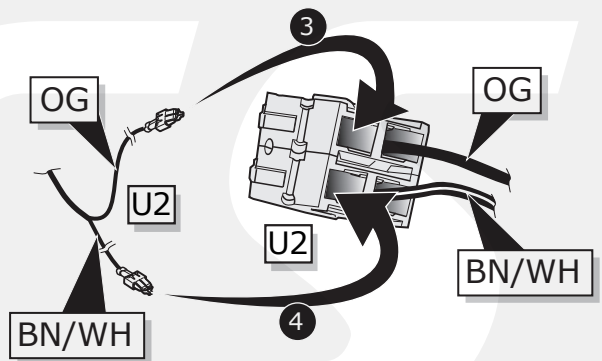
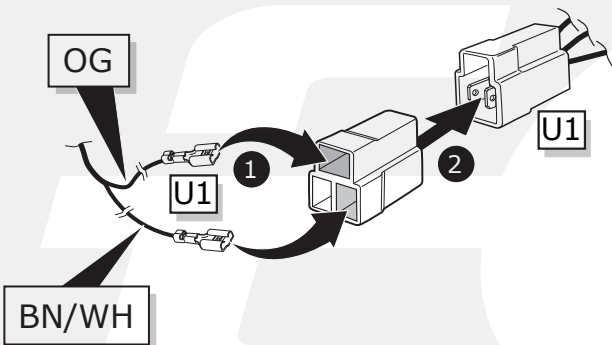

22

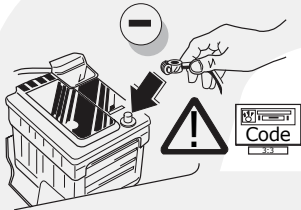

23

- DE** FUNKTIONEN KONTROLLIEREN MIT EINEM PRÜFGERÄT MIT WIDERSTAND ODER MIT LEUCHTEN MIT DER GENAUEN WATTZAHL!
- FR** CONTRÔLER LES FONCTIONS AVEC UNE BOÎTE DE TEST AVEC DE LA CHARGE OU DES LAMPES AVEC LA QUANTITÉ CORRECTE DE WATT!
- NL** CONTROLEER FUNCTIES MET EEN TESTER MET BELASTING OF LAMPEN MET DE JUISTE WATTAGE!
- GB** CHECK FUNCTIONS WITH A TESTBOX WITH LOAD OR LAMPS WITH THE RIGHT AMOUNT OF WATT!
- ES** ¡CONTROLAR FUNCIONES CON UN TESTER CON CARGA O LUCES CON EL CORRECTO WATTAJE!
- IT** CONTROLLA FUNZIONI CON UN TESTER CON CARICO O LAMPADRE DEL GIUSTO WATT-TAGGIO!
- SE** KONTROLLERA FUNKTIONERNA MED EN TESTARE MED BELASTNING ELLER LAMPOR MED RÄTT WATT-VÄRDE!
- CZ** OVĚŘTE FUNKCE POMOCÍ TESTOVACÍHO BOXU NEBO SVĚTEL S PŘÍSLUŠNÝM VÝKONEM!
- DK** CHECK FUNKTIONERNE MED EN TESTBOKS, MED BELASTNING ELLER MED LYGTER MED DET KORREKTE ANTAL WATT!
- FI** TARKISTA TOIMINNOT KÄYTTÄMÄLLÄ TESTILAITE, JOSSA ON OIKEATEHOINEN KUORMITUS TAI OIKEATEHOISET LAMPUT!
- GR** ΕΛΕΓΞΤΕ ΤΙΣ ΛΕΙΤΟΥΡΓΙΕΣ ΜΕ ΉΝΑ ΚΙΒΩΤΙΟ ΔΟΚΙΜΗΣ ΜΕ ΦΟΡΤΙΟ Ή ΛΑΜΠΗΡΕΣ ΣΩΣΤΗΣ ΠΟΣΟΤΗΤΑΣ ΒΑΤ!
- NO** KONTROLER FUNKSJONENE MED EN TESTER MED BELASTNING ELLER LYSPÆRER MED RIKTIG WATTVERDI!
- PL** SPRAWDŹ FUNKCJE UŻYWAJĄC SKRZYŃKI TESTOWEJ Z OBCIĄŻENIEM LUB PODŁĄCZONYMI ŻARÓWKAMI O ODPOWIEDNIEJ MOCY!

24

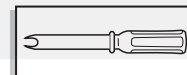
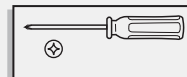
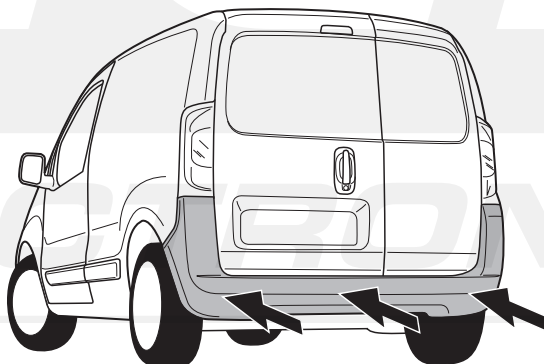

25

2x

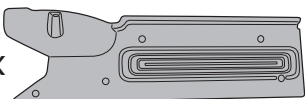

1

2x

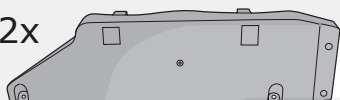

2

3

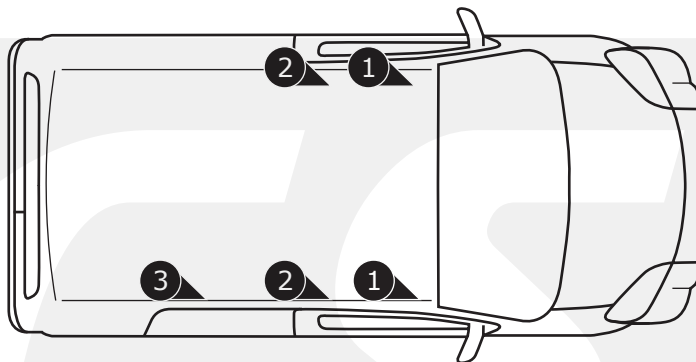
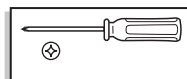

26

- DE** Gebrauchsanleitung.
- FR** Mode d'emploi.
- NL** Gebruikershandleiding.
- GB** User guide.
- ES** Guía del usuario.
- IT** Manuale di istruzioni.
- SE** Bruksanvisning.
- CZ** Uživatelská příručka.
- DK** Brugervejledning.
- FI** Käyttöohjeet.
- GR** Οδηγός χρήστη.
- NO** Brukerveiledning.
- PL** Instrukcja obsługi.

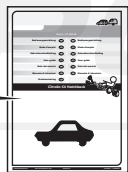
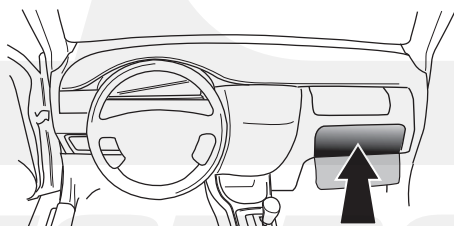

**00800**  
**CALL2ECS**  
**22 55 23 27**

09.00 - 18.00

Monday - Friday

[www.ecs-electronics.nl](http://www.ecs-electronics.nl)

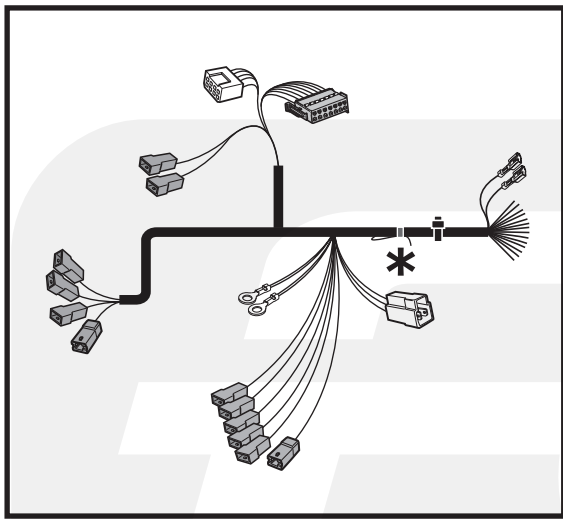

(DE) Option  
 (FR) Option  
 (NL) Optie  
 (GB) Option  
 (ES) Opción  
 (IT) Opzione  
 (SE) Tillval  
 (CZ) Varianta  
 (DK) Ekstraudstyr  
 (FI) Vaihtoehto  
 (GR) Επιλογή  
 (NO) Eventuelt  
 (PL) Opcja

PARK DISTANCE CONTROL

↓

PARK DISTANCE CONTROL

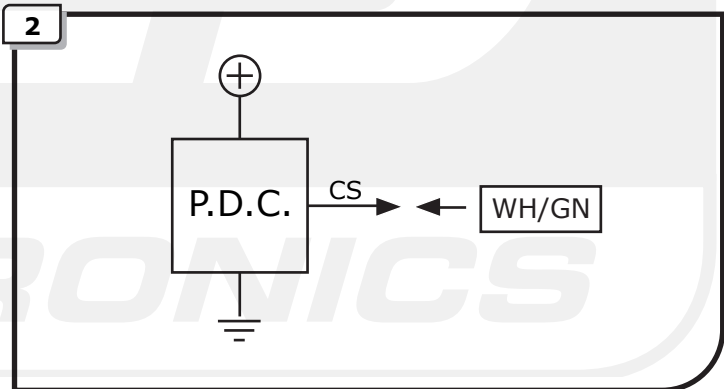
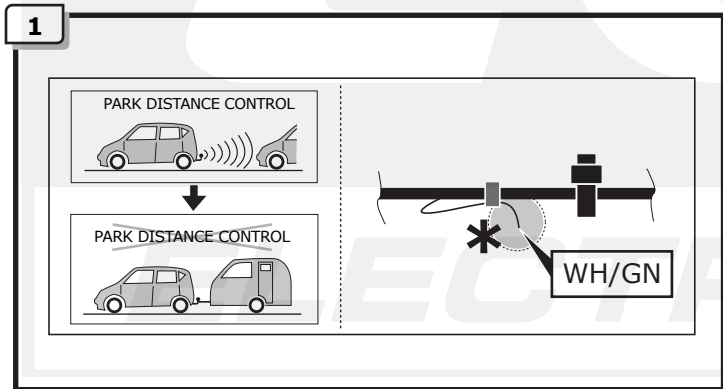

(DE) Anschluss Steckdose  
 (FR) Connection de la prise  
 (NL) Contactdoos aansluiting  
 (GB) Socket connection

(ES) Conexión de la caja de enchufe  
 (IT) Allaccio zoccolo  
 (SE) Anslutning kontaktdosa

(CZ) Objímkový konektor  
 (DK) Stikdåse forbindelse  
 (FI) Pistorasia liitäntä  
 (GR) Υποδοχή σύνδεσης  
 (NO) Tilkobling koblingsboks  
 (PL) Połączenie przez gniazdo

DIN/ISO 11446	↔		≡ 1-8	↕			6/54		7/58-L	Reverse			≡ 10	—	≡ 9
Pmax	1/L	2	3/31	4/R	5/58-R	52W	3x21W	52W	52W	8	180W/15Amp.	180W/15Amp.	11	12	13
(DE)	Gelb	Blau	Weiß	Grün	Braun	Schwarz	Rot (1,00mm <sup>2</sup> )	Schwarz	Schwarz	Schwarz/ Rot	Braun/ Weiß	Rot (2,50mm <sup>2</sup> )	Weiß	-	Weiß
(FR)	Jaune	Bleu	Blanc	Vert	Marron	Noir	Rouge (1,00mm <sup>2</sup> )	Noir	Noir	Noir/ Rouge	Marron/ Blanc	Rouge (2,50mm <sup>2</sup> )	Blanc	-	Blanc
(NL)	Geel	Blauw	Wit	Groen	Bruin	Zwart	Rood (1,00mm <sup>2</sup> )	Zwart	Zwart	Zwart/ Rood	Bruin/ Wit	Rood (2,50mm <sup>2</sup> )	Wit	-	Wit
(GB)	Yellow	Blue	White	Green	Brown	Black	Red (1,00mm <sup>2</sup> )	Black	Black	Black/ Red	Brown/ White	Red (2,50mm <sup>2</sup> )	White	-	White
(ES)	Amarillo	Azul	Blanco	Verde	Marrón	Negro	Rojo (1,00mm <sup>2</sup> )	Negro	Negro	Negro/ Rojo	Marrón/ Blanco	Rojo (2,50mm <sup>2</sup> )	Blanco	-	Blanco
(IT)	Giallo	Blu	Bianco	Verde	Marrone	Nero	Rosso (1,00mm <sup>2</sup> )	Nero	Nero	Nero/ Rosso	Marrone/ Bianco	Rosso (2,50mm <sup>2</sup> )	Bianco	-	Bianco
(SE)	Gul	Blä	Vit	Grön	Brun	Svart	Röd (1,00mm <sup>2</sup> )	Svart	Svart	Svart/ Röd	Brun/ Vit	Röd (2,50mm <sup>2</sup> )	Vit	-	Vit
(CZ)	Žlutá	Modrá	Bílá	Zelená	Hnědá	Černá	Červená (1,00mm <sup>2</sup> )	Černá	Černá	Černo/ Červená	Hnědo/ Bílá	Červená (2,50mm <sup>2</sup> )	Bílá	-	Bílá
(DK)	Gul	Bla	Hvid	Grøn	Brun	Sort	Rød (1,00mm <sup>2</sup> )	Sort	Sort	Sort/ Rød	Brun/ Hvid	Rød (2,50mm <sup>2</sup> )	Hvid	-	Hvid
(FI)	keltainen	Sininen	Valkoinen	Vihreä	Ruskea	Musta	Punainen (1,00mm <sup>2</sup> )	Musta	Musta	Musta/ Punainen	Ruskea/ Valkoinen	Punainen (2,50mm <sup>2</sup> )	Valkoinen	-	Valkoinen
(GR)	Κίτρινο	Μπλε	Λευκό	Πράσινο	Καφέ	Μαύρο	Κόκκινο (1,00mm <sup>2</sup> )	Μαύρο	Μαύρο	Μαύρο/ Κόκκινο	Καφέ/ Λευκό	Κόκκινο (2,50mm <sup>2</sup> )	Λευκό	-	Λευκό
(NO)	Gul	Bla	Hvit	Grønn	Brun	Svart	Rød (1,00mm <sup>2</sup> )	Svart	Svart	Svart/ Rød	Brun/ Hvit	Rød (2,50mm <sup>2</sup> )	Hvit	-	Hvit
(PL)	Żółty	Niebieski	Biały	Zielony	Brazowy	Czarny	Czerwony (1,00mm <sup>2</sup> )	Czarny	Czarny	Czarny/ Czerwony	Brazowy/ Biały	Czerwony (2,50mm <sup>2</sup> )	Biały	-	Biały