

Ford Focus Hatchback 2003- & 2006- Partn.: FR-031-BH

- | | |
|--|---|
| <p>DE Einbauanleitung Elektrosatz Anhängervorrichtung mit 12-N Steckdose It. DIN/ISO Norm 1724.</p> <p>FR Instructions de montage du faisceau électrique pour crochet d'attelage conforme à la norme DIN/ISO 1724 prise 12-V</p> <p>NL Montage-handleiding elektrokabelset voor trekhaak met 12-N contactdoos vlg. DIN/ISO norm 1724.</p> <p>GB Fitting instructions electric wiring kit tow bar with 12-N socket up to DIN/ISO Norm 1724.</p> <p>ES Instrucciones de montaje de kit eléctrico para engancho de remolque con caja de conexiones 12-N según norma DIN/ISO 1724.</p> <p>IT Istruzioni di montaggio di set di cavi elettrici per gancio da traino con zoccolo a 12 N conforme alla norma DIN/ISO 1724.</p> <p>SE Monteringsanvisningar elkabelsats för dragkrok med 12-N kontaktdosa enligt DIN/ISO norm 1724.</p> | <p>CZ Montážní pokyny: souprava pro elektrické propojení tažné tyče s 12 - N zásuvkou do normy DIN/ISO 1724.</p> <p>DK Monteringsvejledninger for det elektriske ledningsføringssæt for trækstang med 12-N stikdåse, DIN/ISO, norm 1724.</p> <p>FI Ohjeet vetokoukun sähkökaapelisarjan asentamiseen, jossa on DIN/ISO 1724 mukainen 12-N liitin.</p> <p>GR Οδηγίες συναρμολόγησης ηλεκτρικού σετ καλωδίων μπάρας ρυμούλκησης με υποδοχή 12-N μέχρι DIN/ISO Κανόνας 1724.</p> <p>NO Monteringsanviser elkabelsett for trekrok med 12-N koblingsboks ifølge DIN/ISO norm 1724.</p> <p>PL Instrukcje montażu zestawu okablowania elektrycznego dyszla holowniczego z 12-N stykowym gniazdem DIN/ISO 1724.</p> |
|--|---|

- | | |
|--|---|
| <p>DE - Wir weisen ausdrücklich darauf hin, dass eine unsachgemäße und nicht in einer Fachwerkstatt durchgeführte Montage einen Verzicht auf Entschädigung jeglicher Art insbesondere bezüglich des Produkthaftpflichtrechts zur Folge hat.</p> <p>FR - Il est expressément prévu qu' on ne saurait se prévaloir d'un quelconque préjudice contractuel ou rédhibitoire si le montage avait été fait en dépit des dites instructions ou dans un garage ne disposant pas des équipements adéquats.</p> <p>NL - Wij wijzen er met nadruk op, dat ondeskundige en niet door een vakkundige werkplaats uitgevoerde montage tot gevolg heeft dat daardoor ieder recht op schadevergoeding, ook op wettelijke aansprakelijkheid inzake producten, vervalt.</p> <p>GB - We would expressly point out that assembly not carried out properly by a competent installer will result in cancellation of any right to damage compensation, in particular those arising by virtue of the product liability act.</p> <p>ES - El montaje inapropiado y efectuado por personal no cualificado originará la pérdida de todo derecho a indemnización o la expiración de toda responsabilidad civil con respecto al producto.</p> <p>IT - Sottolineiamo espressamente che un montaggio inadeguato ed eseguito da un'officina non specializzata ha come conseguenza il decadere di qualsiasi diritto al risarcimento danni, nonché alla responsabilità legale relativa ai prodotti.</p> <p>SE - Vi påpekar med eftertryck att all rätt till skadeersättning och all laglig ansvarighet förfaller om monteringen inte har utförts på rätt sätt och av en professionell verkstad.</p> <p>CZ - Výslovně zdůrazňujeme, že jakákoli montáž, která není provedená ve specializované dílně, má za následek odvolání nároků na kompenzaci jakéhokoliv druhu, obzvláště vyplývajících ze zákona o odpovědnosti za způsobené škody.</p> <p>DK - Vi ønsker at gøre udtrykkeligt opmærksom på at forkert samling, der ikke er udført af et specialiseret værksted, resulterer i bortfaldelse af kompenseringskrav af alle slags, i særdeles krav der måtte opstå omkring det lovpligtige ansvar.</p> <p>FI - Korostamme, että kaikki oikeudet vahinkokorvaukseen kuten myös valmistajan laillinen vastuu raukeavatt, mikäli asennusta ei ole toteutettu oikealla tavalla eikä ammattitaitoisen asiantuntijan toimesta.</p> <p>GR - Επισημαίνουμε κατηγορηματικά ότι οποιαδήποτε εσφαλμένη συναρμολόγηση, η οποία δεν έχει πραγματοποιηθεί ειδικό εργαστήριο θα οδηγήσει σε απονοίηση των αξιώσεων επιβολής αποζημιώσεων οποιαδήποτε είδους, ειδικά όσα προκύπτουν από το νόμο ευθύνης προϊόντων.</p> <p>NO - Vi påpeker ettertrykkelig at all rett til skadeerstatning og rettslig ansvar forfaller dersom monteringen ikke er blitt utført på riktig måte og av et profesjonelt verksted.</p> <p>PL - Chcielibyśmy wyraźnie zaznaczyć, iż wszelki nieprawidłowy montaż, który nie jest wykonywany w specjalistycznym warsztacie pociąga za sobą utratę możliwości dochodzenia wszelkiego typu roszczeń, w szczególności tych wynikających z odpowiedzialności producenta za swój produkt.</p> | <p>- Technische Änderungen vorbehalten.</p> <p>- Widerstand nur gemäß der Tabelle auf dem Anhänger verwenden, siehe Seite 14.</p> <p>- Sous réserve de modifications techniques.</p> <p>- Ne excédez pas la charge maximale, indiquée dans le tableau sur page 14.</p> <p>- Technische wijzigingen voorbehouden.</p> <p>- Gebruik alleen belasting volgens aansluittabel op het getrokken voertuig, zie pagina 14.</p> <p>- Contents of these kits and their fitting manuals are subject to alteration without notice, please ensure that these instructions are read and fully understood before commencing installation.</p> <p>- Do not overload circuits; the maximum loads per connection are detailed in this manual.</p> <p>- Nos reservamos el derecho a efectuar modificaciones técnicas.</p> <p>- Utilice sólo cargas de acuerdo a la tabla de conexión del vehículo remolcado (ver página 14).</p> <p>- Ci si riserva il diritto di apportare modifiche tecniche.</p> <p>- Utilizzare esclusivamente un carico conforme alla tabella degli allacci relativa al veicolo in questione, cfr. pagina 14.</p> <p>- Tekniska ändringar förbehålles.</p> <p>- Använd endast belastning enligt anslutningstabellen på det dragna fordonet, se sid. 14.</p> <p>- Změny mohou být provedeny bez oznámení.</p> <p>- Používejte pouze při maximálním nabití podle tabulky na tažném vozidle, viz. str. 14.</p> <p>- Kan ændres uden varsel.</p> <p>- Brug kun den maksimale belastning, i overensstemmelse med forbindelsestabelen for bugserede køretøjer, side 14.</p> <p>- Oikeus teknisiin muutoksiin ilman erillistä huomautusta pidetään.</p> <p>- Kuormita työvirtapiiriä ainoastaan hinattavan ajoneuvon kytkentäkaavion mukaisesti, katso sivu 14.</p> <p>- Μπορεί να τροποποιηθεί χωρίς προηγούμενη ειδοποίηση.</p> <p>- Χρησιμοποιείτε μόνο μέγιστο ηλεκτρικό φορτίο σύμφωνα με τον πίνακα σύνδεσης στο ρυμούλκούμενο όχημα, δείτε σελίδα 14.</p> <p>- Tekniske endringer forbeholdes. - Overskrid ikke grensene anviset i tilkoblingstabellen på tilhengeren eller det tilkoblede kjøretøyet, se s. 14.</p> <p>- Podlega zmianom bez powiadomienia.</p> <p>- Używać tylko takiego maksymalnego obciążenia które wynika z tabliczki połączeń holowanego pojazdu, patrz strona 14.</p> |
|--|---|

Einzelteilliste

Liste de pieces

Onderdelenlijst

Part list

Lista de componentes

Elenco componenti

Dellista

Seznam dílů

Del-liste

Osaluettelo

Κατάλογος εξαρτημάτων

Delliste

Lista części

(DE)

(FR)

(NL)

(GB)

(ES)

(IT)

(SE)

(CZ)

(DK)

(FI)

(GR)

(NO)

(PL)

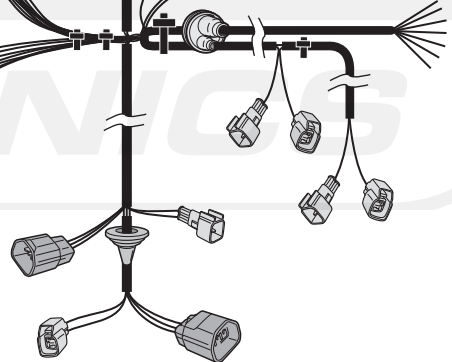
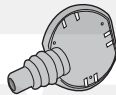
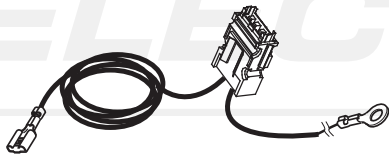
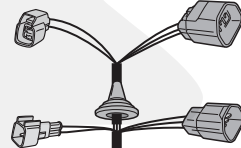
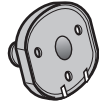
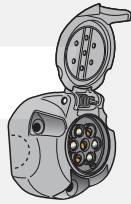
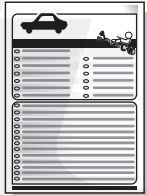
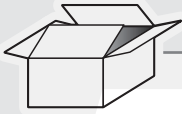

Option! *

- (DE) Vorbereitung für P.D.C.
- (FR) Préparation P.D.C.
- (NL) Preparatie voor P.D.C.
- (GB) Voorbereiding voor P.D.C.
- (ES) Preparación para P.D.C.
- (IT) Preparazione per P.D.C.
- (SE) Förberedelse för P.D.C.
- (CZ) Příprava pro P.D.C.
- (DK) Forberedelse for P.D.C.
- (FI) Valmistelu P.D.C. varten
- (GR) Προετοιμασία για P.D.C.
- (NO) Forberedelse på P.D.C.
- (PL) Przygotowanie do P.D.C.

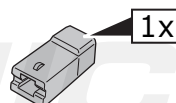
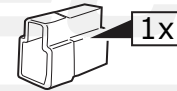
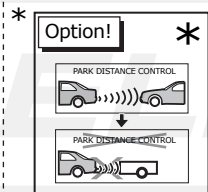
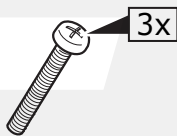
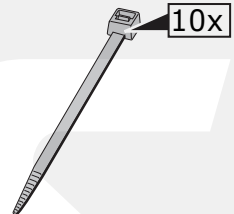
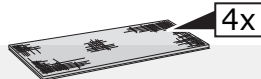
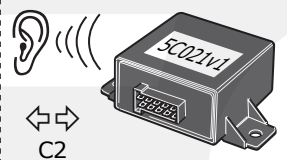
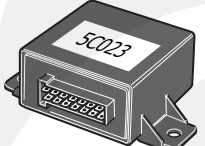
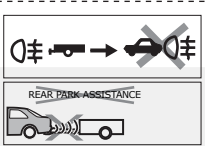

1

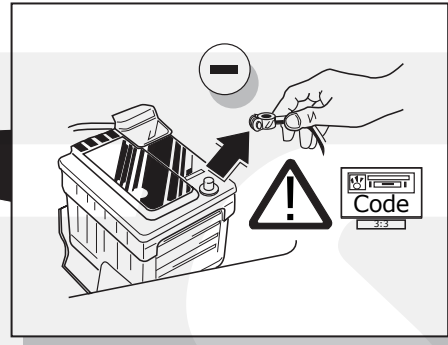
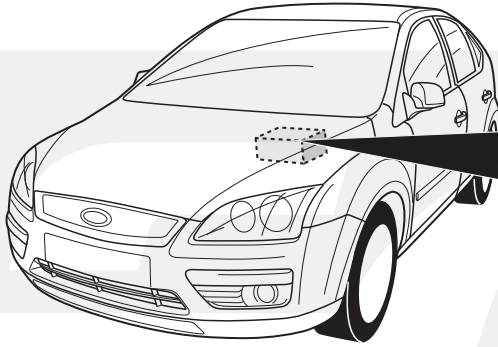

2

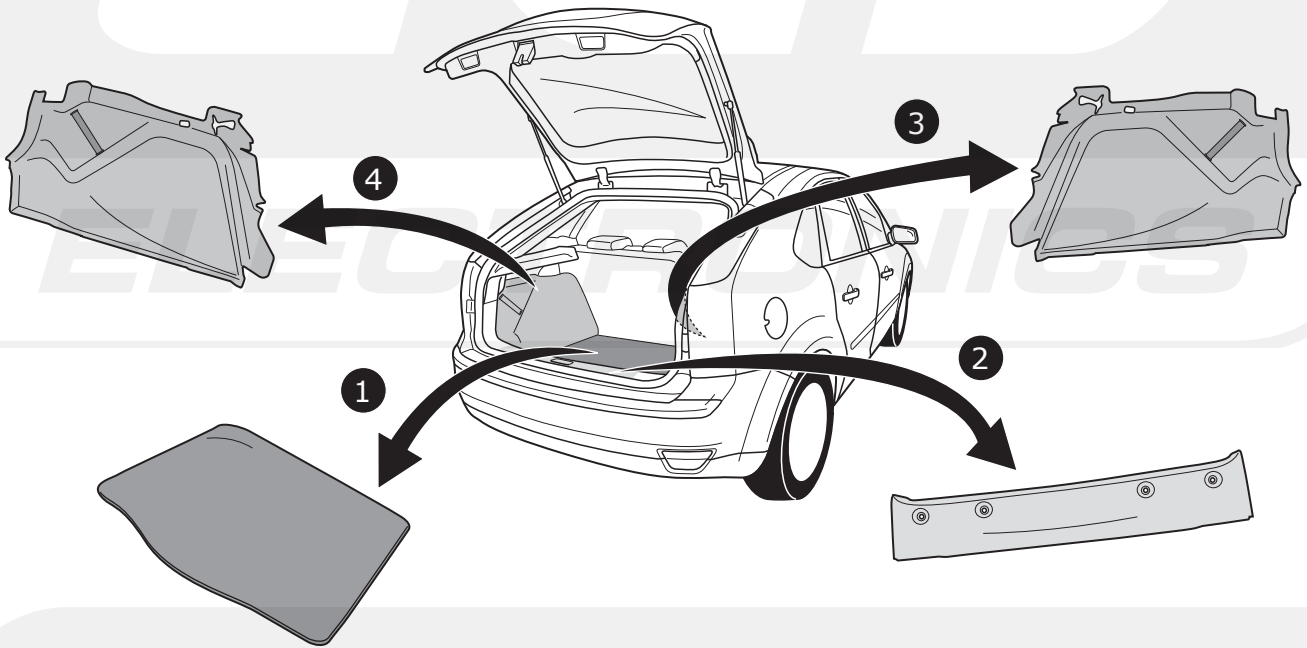

3

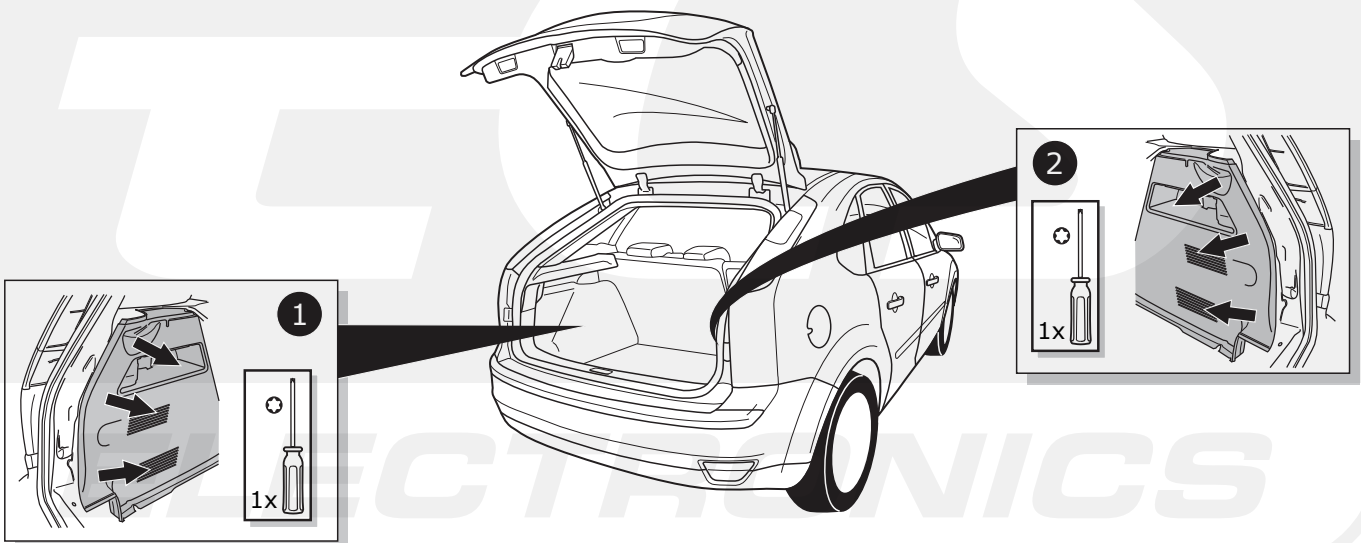

INFO

Option! T

PARK DISTANCE CONTROL

PARK DISTANCE CONTROL

Pag. 13

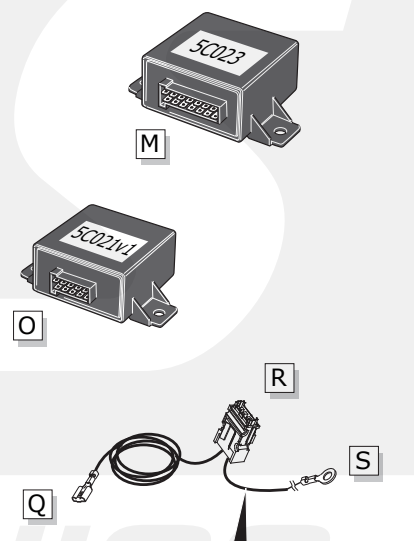
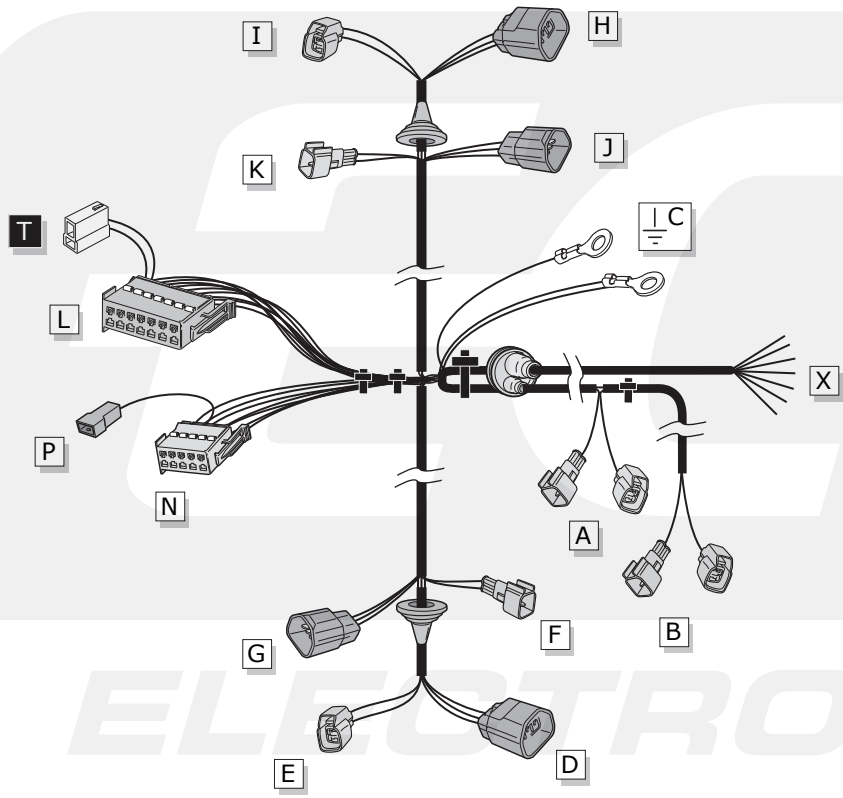

15 Amp.

DE	Orange	EZ	Oranžová
FR	Orange	OK	Orange
NL	Oranje	FI	Oranssi
GB	Orange	GR	Πορτοκαλί
ES	Naranja	NO	Oransje
IT	Arançione	PL	Pomarańczowy
SE	Orange		

ROUTING

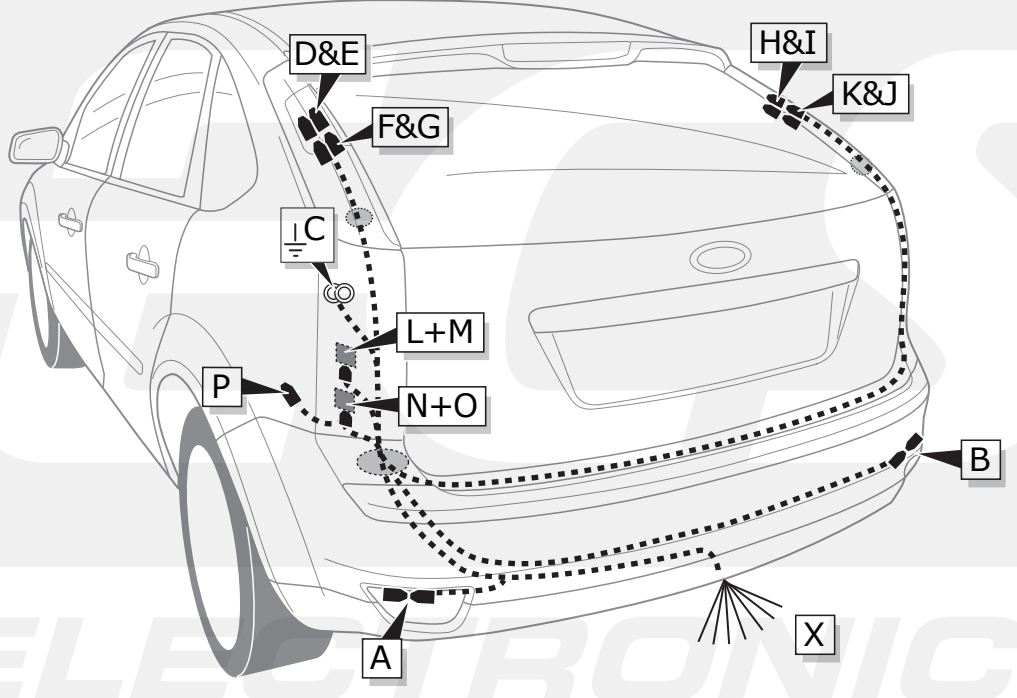

4

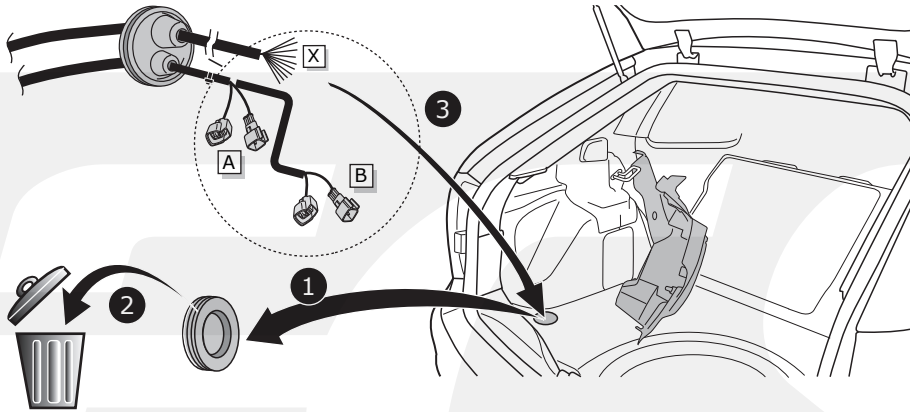

A

Option 1

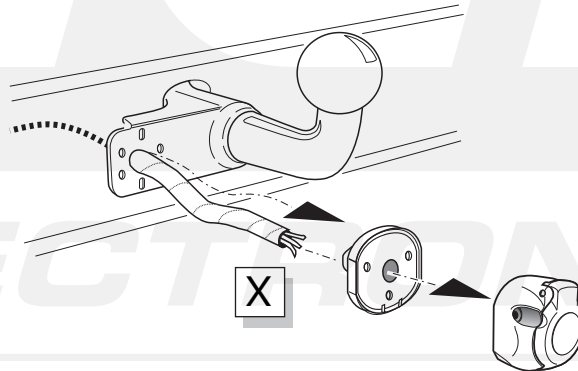

Option 2

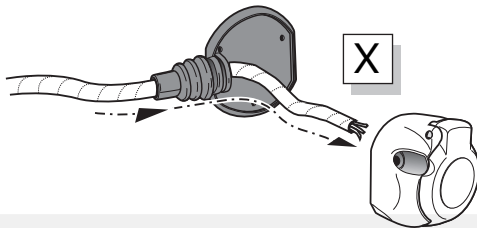

Option 3

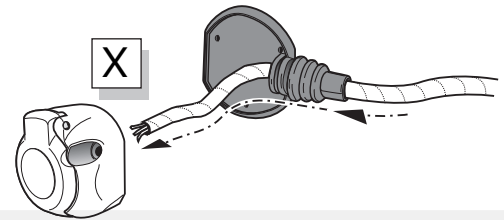

INFO

- | | |
|-------------------------------------|-------------------------------|
| (DE) Anschluss Steckdose | (CZ) Objímkový konektor |
| (FR) Connection de la prise | (DK) Stikdåse forbindelse |
| (NL) Contactdoos aansluiting | (FI) Pistorasia liitäntä |
| (GB) Socket connection | (GR) Υποδοχή σύνδεσης |
| (ES) Conexión de la caja de enchufe | (NO) Tilkobling koblingsboks |
| (IT) Allaccio zoccolo | (PL) Połączenie przez gniazdo |
| (SE) Anslutning kontaktdosa | |



Pag. 14

B

Option 1

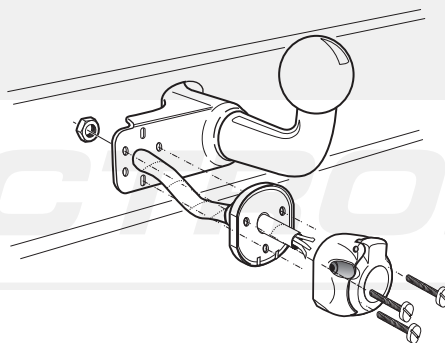

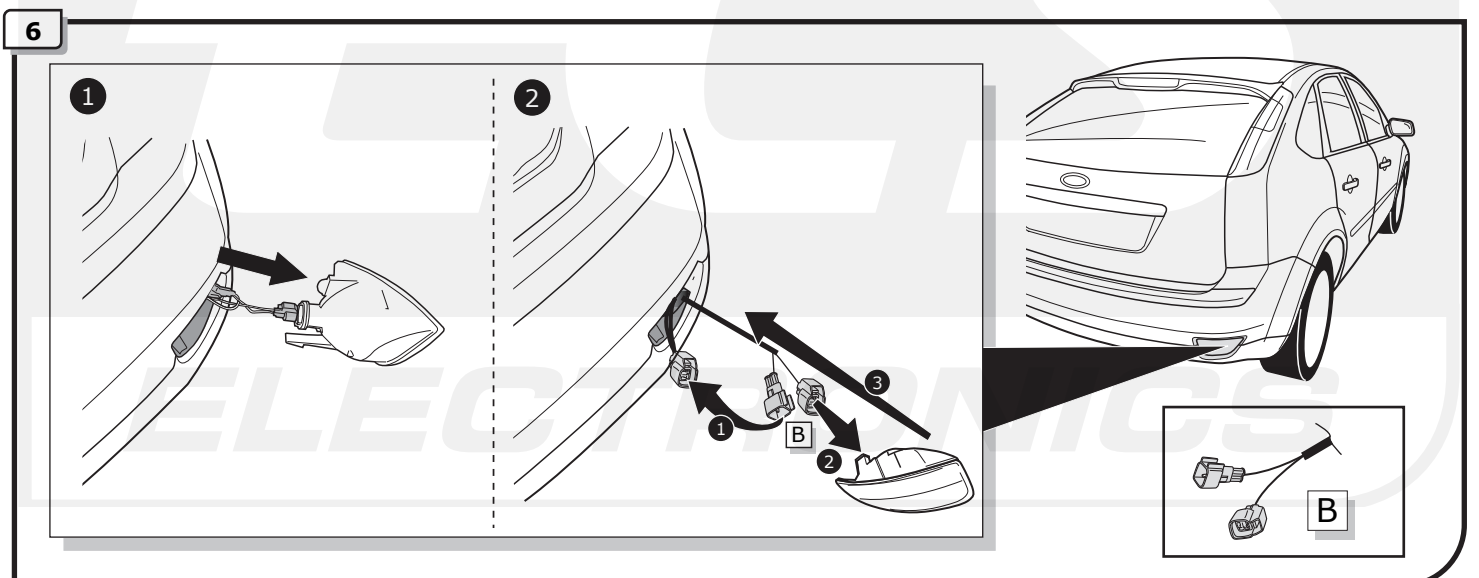
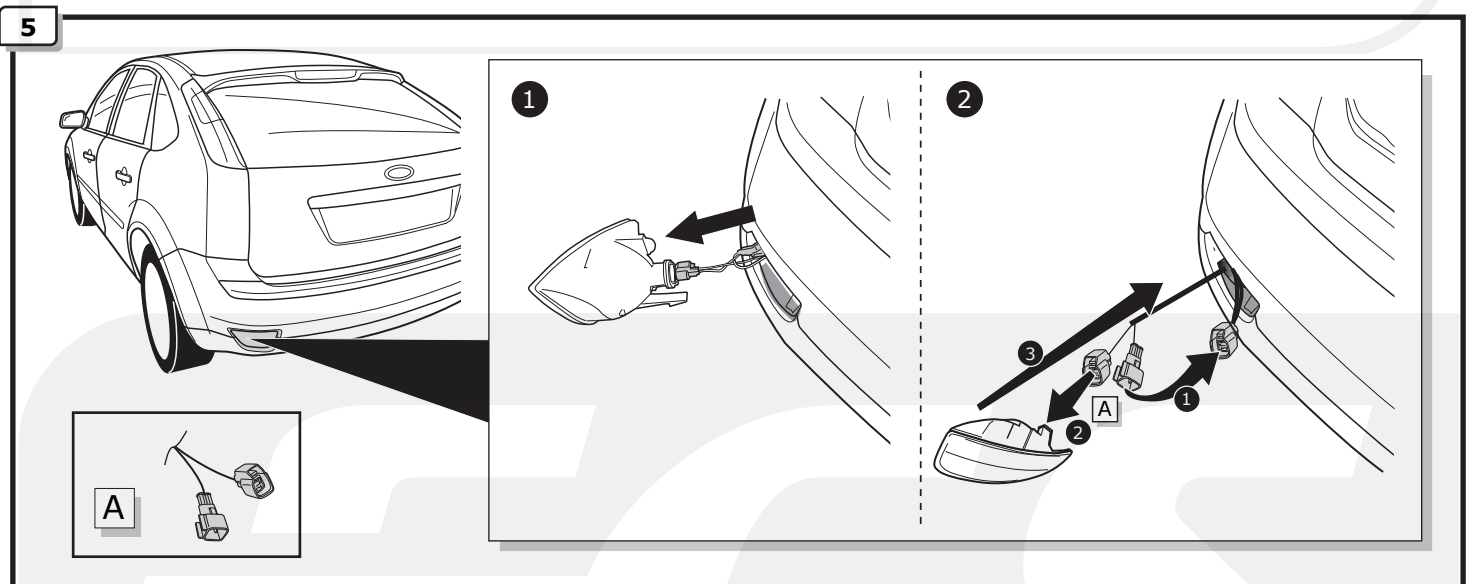
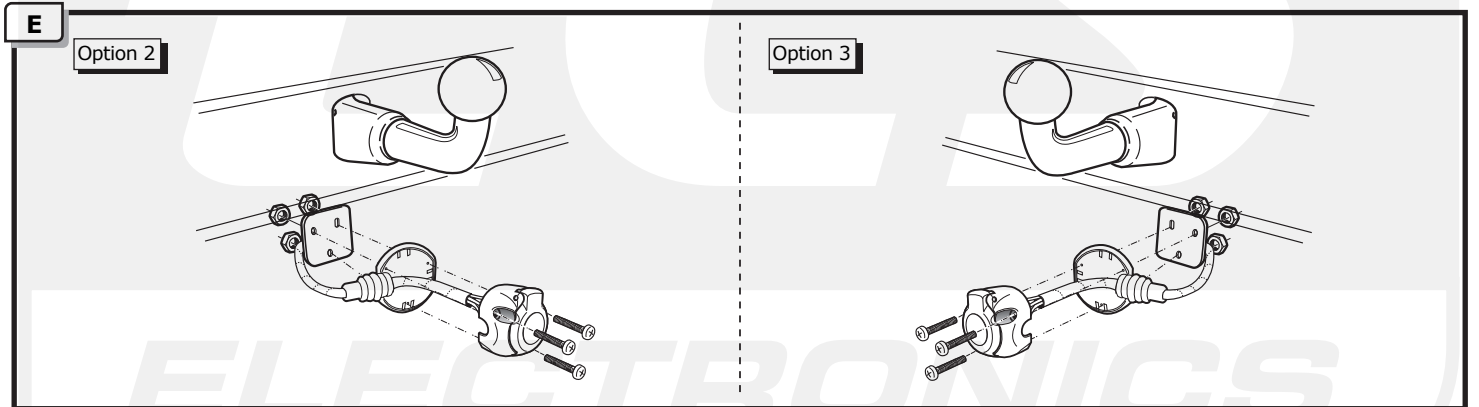
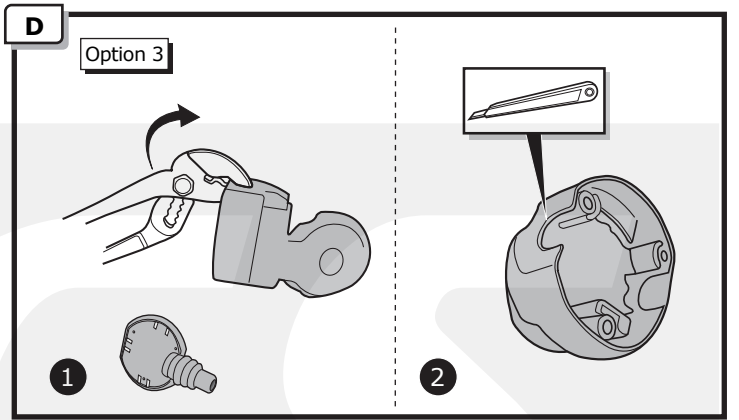
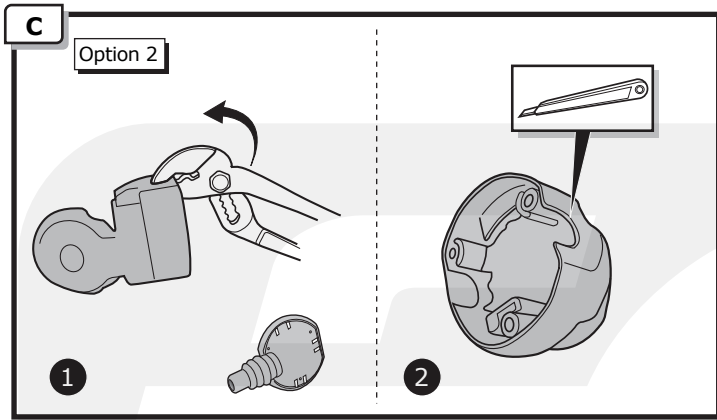

7

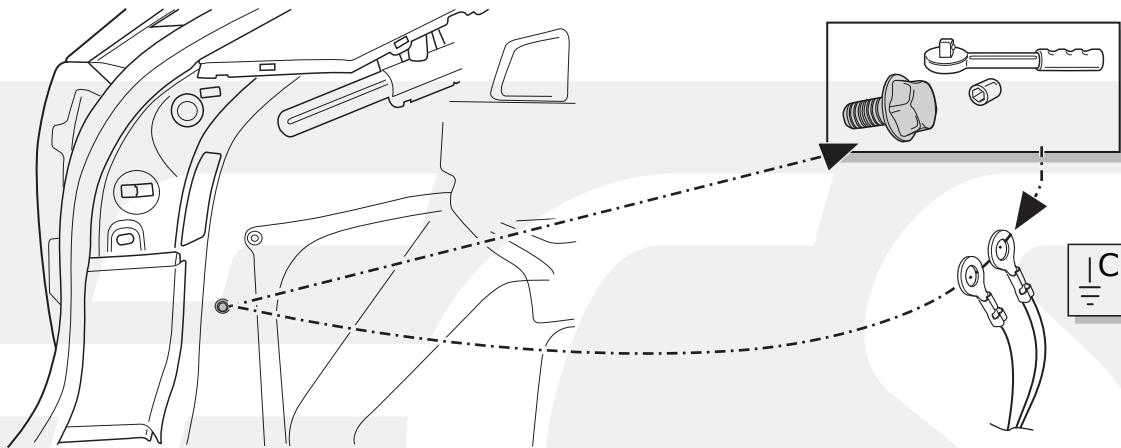

8

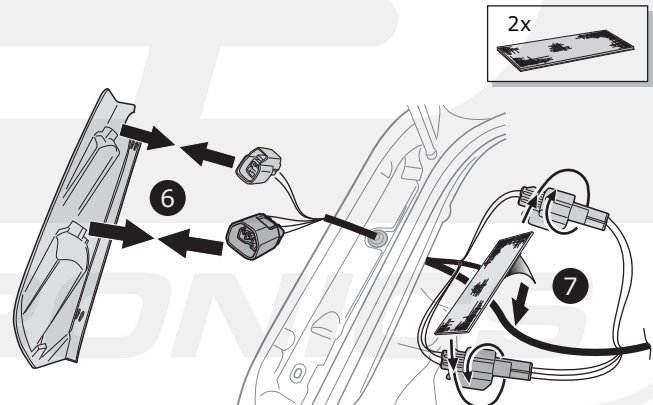
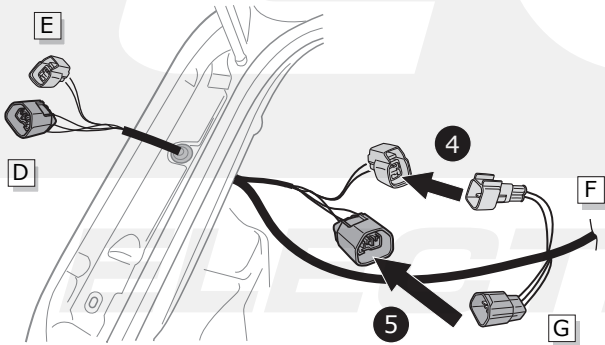
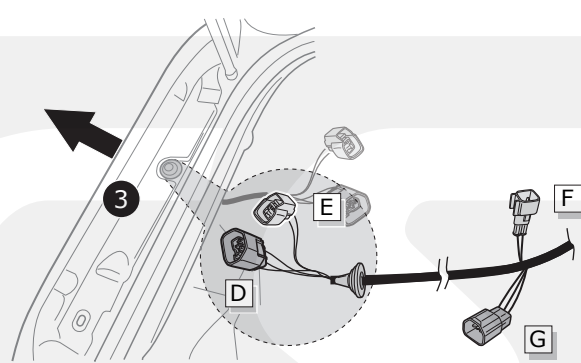
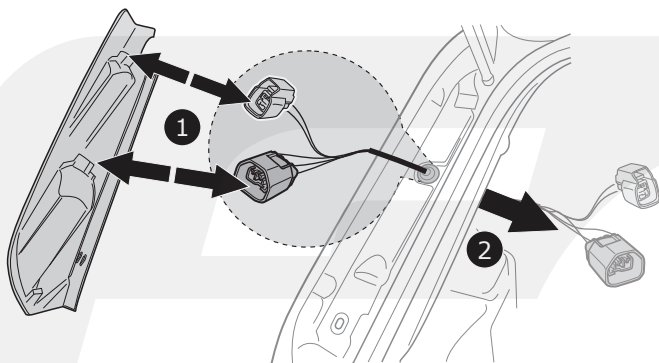
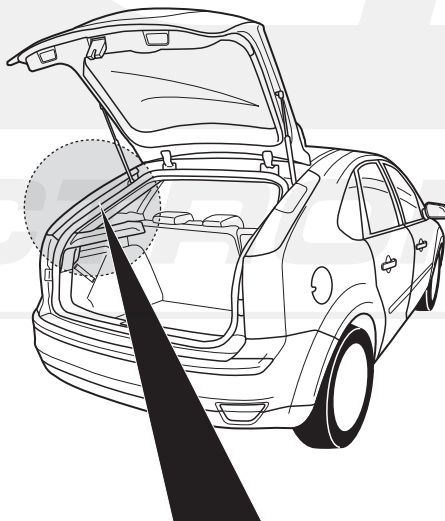

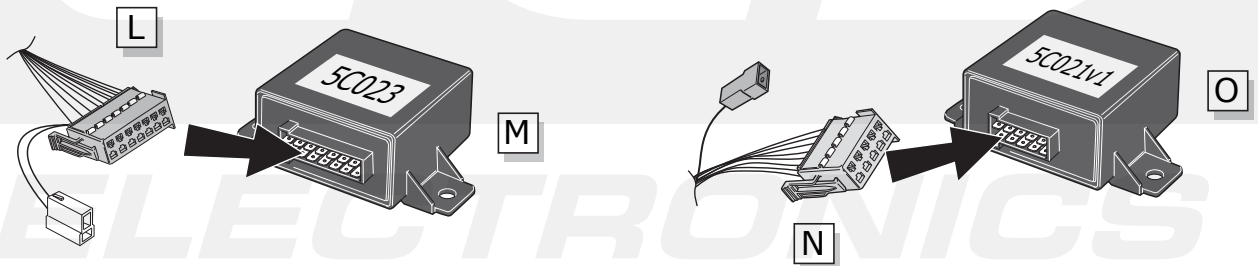
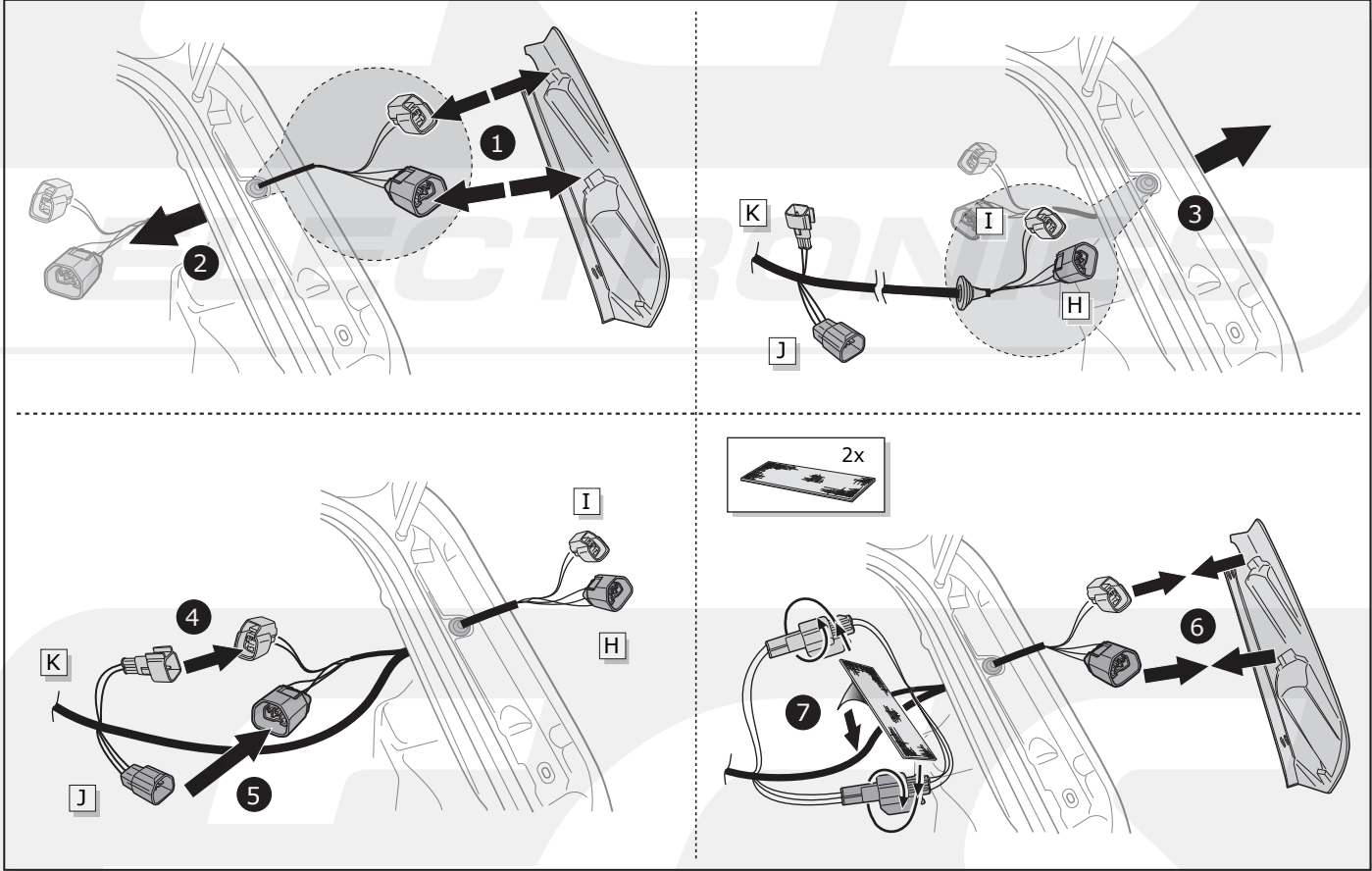
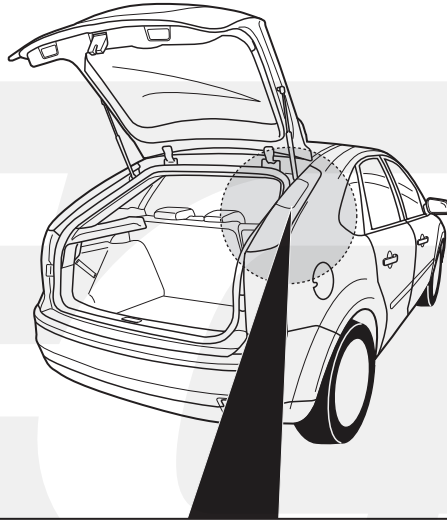

11

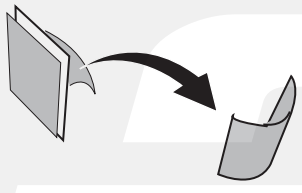
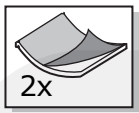

1

2x

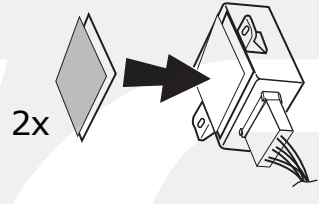

2

2x

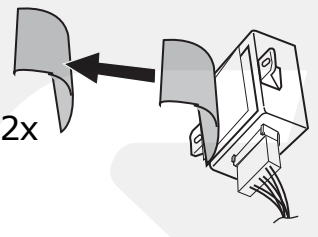

3

12

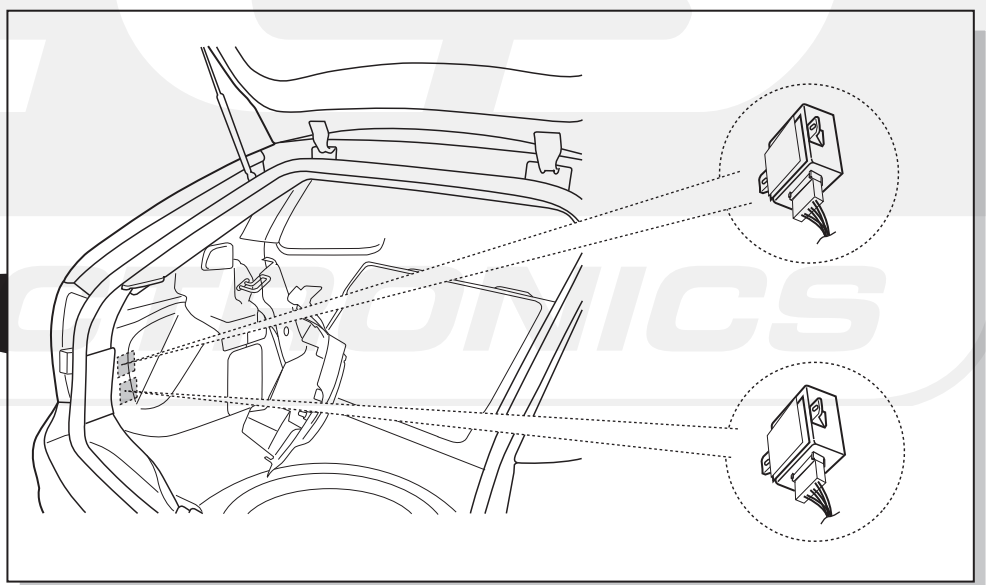
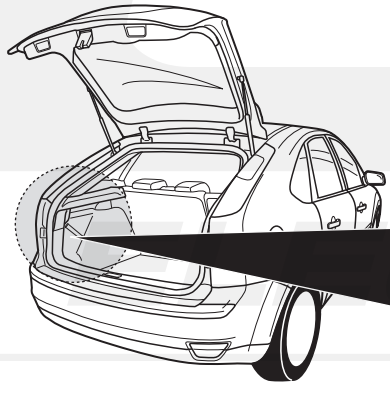

13a

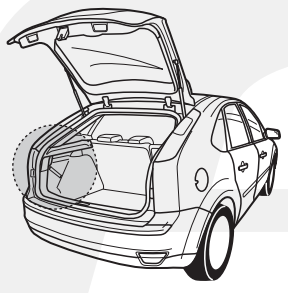

Option 1

→ 09/2005

Option 2

→ 14

13b

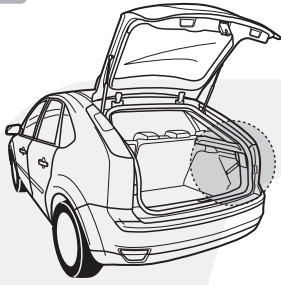

Option 2

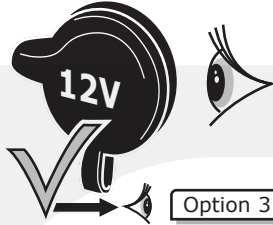

Option 3

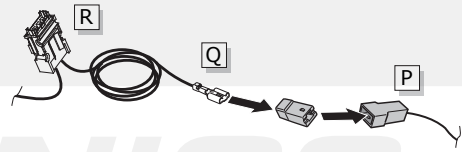
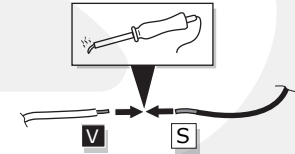
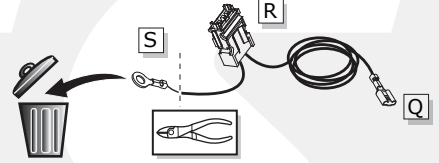
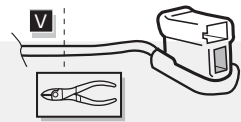
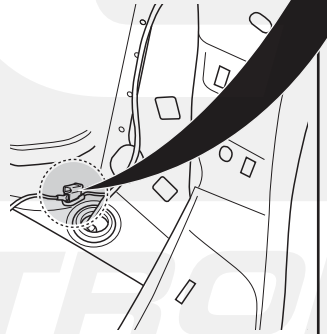
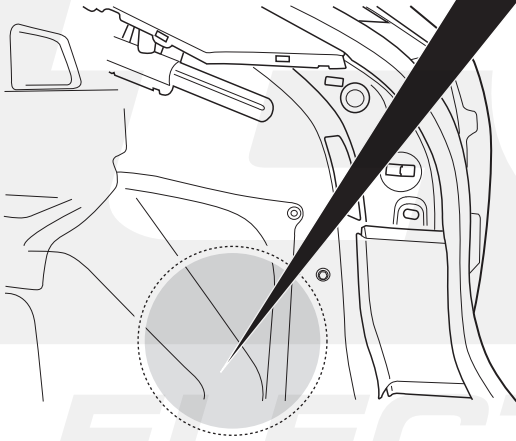

13c

Option 3

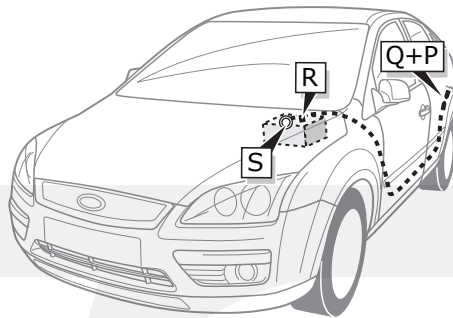

15 Amp.



- DE Orange
- FR Orange
- NL Orange
- GB Orange
- ES Naranja
- IT Arancione
- SE Orange
- CZ Oranžová
- DK Orange
- FI Oranssi
- GR Πορτοκαλί
- NO Oransje
- PL Pomarańczowy

+30

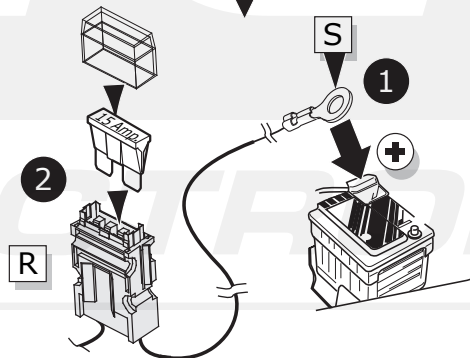
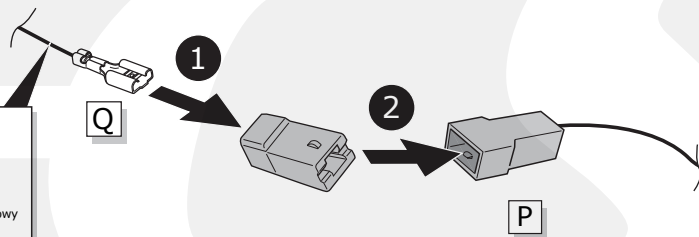

14

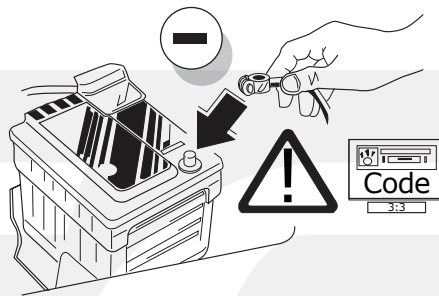

15

(DE) FUNKTIONEN KONTROLLIEREN MIT EINEM PRÜFGERÄT MIT WIDERSTAND ODER MIT LEUCHTEN MIT DER GENAUEN WATTZAHL!

(FR) CONTRÔLER LES FONCTIONS AVEC UNE BOÎTE DE TEST AVEC DE LA CHARGE OU DES LAMPES AVEC LA QUANTITÉ CORRECTE DE WATT!

(NL) CONTROLEER FUNCTIES MET EEN TESTER MET BELASTING OF LAMPEN MET DE JUISTE WATTAGE!

(GB) TEST ALL CIRCUIT FUNCTIONS WITH A TESTBOX WITH THE CORRECT POWER LOAD FOR EACH UNIT. A TESTBOX ON WHICH ONLY LEDs ARE USED CAN NOT BE USED IN THIS CASE

(ES) ¡CONTROLA FUNCIONES CON UN TESTER CON CARGA O LUCES CON EL CORRECTO WATTAJE!

(IT) CONTROLLA FUNZIONI CON UN TESTER CON CARICO O LAMPADE DEL GIUSTO WATT-TAGGIO!

(SE) KONTROLLERA FUNKTIONERNA MED EN TESTARE MED BELASTNING ELLER LAMPOR MED RÄTT WATT-VÄRDE!

(CZ) OVĚŘTE FUNKCE POMOČÍ TESTOVACÍHO BOXU NEBO SVĚTEL S PŘÍSLUŠNÝM VÝKONEM!

(DK) CHECK FUNKTIONERNE MED EN TESTBOKS, MED BELASTNING ELLER MED LYGTER MED DET KORREKTE ANTAL WATT!

(FI) TARKISTA TOIMINNOT KÄYTTÄMÄLLÄ TESTILAITE, JOSSA ON OIKEATEHOINEN KUORMITUS TAI OIKEATEHOISET LAMPUT!

(GR) ΕΛΕΓΓΕΤΕ ΤΙΣ ΛΕΙΤΟΥΡΓΙΕΣ ΜΕ ΈΝΑ ΚΙΒΩΤΙΟ ΔΟΚΙΜΗΣ ΜΕ ΦΟΡΤΙΟ Ή ΛΑΜΠΗΡΕΣ ΣΩΣΤΗΣ ΠΟΣΟΤΗΤΑΣ ΒΑΤ!

(NO) KONTROLER FUNKSJONENE MED EN TESTER MED BELASTNING ELLER LYSÆRER MED RIKTIG WATTVERDI!

(PL) SPRAWDŹ FUNKCJE UŻYWAJĄC SKRZYŃKI TESTOWEJ Z OBCIĄŻENIEM LUB PODŁĄCZONYMI ŻARÓWKAMI O ODPOWIEDNIEJ MOCY!

16

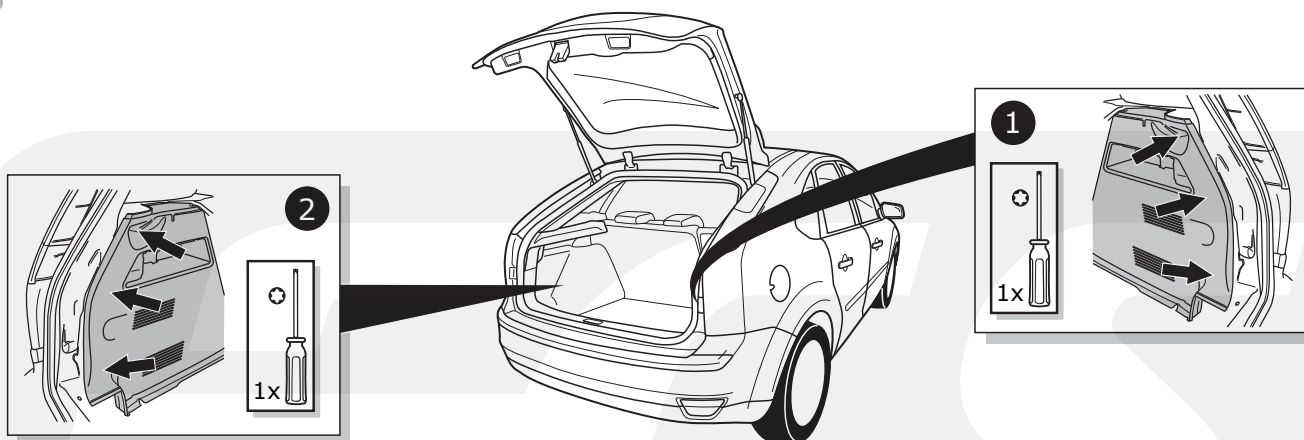

17

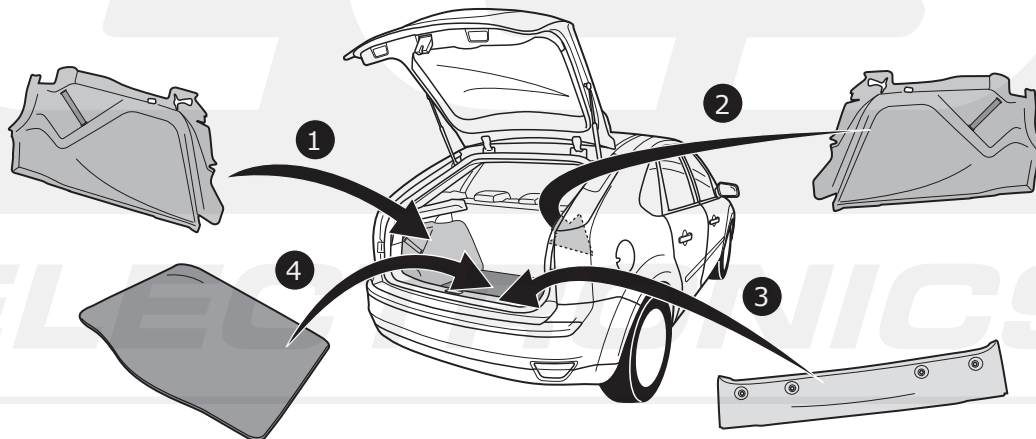

7-polige Kabelsätze mit C2-Steuergerät.

In diesem Kabelsatz wird das C2-Steuergerät anstelle von einem Blinkrelais mit einer C2 Kontrollleuchte verwendet. Ein defektes Blinklicht an Fahrzeug und/oder Anhänger wird durch ein schnelleres Blinken der anderen Blinklichter angezeigt (laut europäischer Richtlinie 76/756/EEC §4.5.8. und StVZO §54).

Um eine Überlastung des C2-Steuergeräts zu vermeiden, dürfen an dem Anhänger nicht mehr als 21W an Blinklichtern auf jeder Seite angeschlossen werden. Die Funktion des C2-Steuergeräts kann durch Anschließen eines Anhängers (oder einer Prüftafel) und Betätigung des Blinkers mit einem herausgedrehten Blinklicht geprüft werden. Die anderen Blinklichter blinken dann schneller. (Achtung: Eine Prüftafel, bei der ausschließlich LED's als Widerstand benutzt werden, kann hierfür nicht verwendet werden).

DE

Faisceau électrique 7 pôles équipé d'un module C2

Dans ce faisceau électrique, le module C2 est utilisé à la place du relais du clignotant qui est équipé d'un deuxième témoin de contrôle C2. Un clignotant défectueux du véhicule ou de la caravane/remorque est signalé par le clignotement plus rapide des autres lampes clignotantes (Suivant les directives européennes 76/756 EEC §4.5.8. et StVZO §54). Afin d'éviter la surcharge du module C2, il ne peut être connecté sur chaque côté de la remorque / caravane qu'une charge maximale de 21W en clignotants. Le fonctionnement du module C2 peut être contrôlé en branchant une remorque/caravane (ou boîte test) et en indiquant une direction avec une lampe clignotante dévissée. Les autres lampes clignotantes clignotent alors plus rapidement. (Attention: une boîte test où ne sont utilisés que les témoins de contrôle comme charge, ne peut être utilisé dans ce cas.)

FR

7-polige kabelsets met C2-module.

In deze kabelset wordt de C2-module toegepast in plaats van een knipperlichtrelais met C2 controlelampje. Een defect knipperlicht van voertuigen en/of aanhanger wordt aangegeven door het versnelde knipperen van de overige knipperlichten (volgens Europese richtlijn 76/756/EEC §4.5.8. en StVZO §54).

Om overbelasting van de C2-module te voorkomen mag op de aanhanger per zijde maximaal 21W aan knipperlichten worden aangesloten. De werking van de C2-module kan getest worden door een aanhanger (of testkast) aan te sluiten en met een losgedraaid knipperlicht richting aan te geven. De andere knipperlichten knipperen nu snel. (LET OP: een testkast waar uitsluitend LED's als belasting gebruikt worden, kan hiervoor niet worden gebruikt.)

NL

7-pole wiring-harness kit with a C2 module.

In this wiring-harness kit, the C2 module is used instead of a flasher relay with a C2 light failure sensor. A defective indicator light of the car or/and caravan/trailer is stated by a quicker flashing of the other indicator light (Following the European directive 76/756/EEC §4.5.8. and StVZO §54). In order to avoid an overload of the C2 module, a maximum of 21W in indicator flashing lights can be connected on each side.

The functioning of the C2-module can be tested by connecting the trailer/caravan (or a test-box) and switching on the indicator lights with a removed indicator light. The other indicator lights will flash quicker. (ATTENTION: a test-box on which only LED's are being used, can not be used in this case).

GB

Kit eléctrico de 7 polos con módulo C2.

En este kit eléctrico se incorpora un módulo C2 en lugar de un relé de luces de intermitencia con piloto de control C2. Una luz de destellos defectuosa en vehículos con o sin remolque se indica mediante el parpadeo rápido de las restantes luces de intermitencia (según norma europea 76/756/EEC §4.5.8. y Código de Circulación alemán (StVZO) §54). Para prevenir la sobrecarga del módulo C2, no deberán conectarse a cada lado del remolque luces de destellos con más de 21 W. El funcionamiento correcto del módulo C2 puede comprobarse acoplando un remolque (o bien una caja de pruebas con luces de 21W) e indicando la dirección mediante una luz de destellos aflojada. Las restantes luces de destellos tendrán que parpadear rápidamente. (ATENCIÓN: para esta prueba no es posible utilizar una caja de pruebas en la que se empleen sólo LED como indicadores de carga.)

ES

Set di cavi a 7 poli con modulo C2.

In questo set di cavi il modulo C2 viene applicato con una lampadina di controllo C2 al posto del relè di un indicatore di direzione. Un indicatore di direzione difettoso del veicolo e/o del rimorchio viene segnalato dal lampeggiare più rapido degli altri indicatori di direzione (in conformità con la direttiva europea 76/756/CEE §4.5.8. e con lo StVZO §54). Per prevenire il sovraccarico del modulo C2, sul rimorchio possono essere allacciati per ciascun lato un massimo di 21W in luci lampeggianti. Il funzionamento del modulo C2 può essere testato agganciando un rimorchio (o una cassetta da test) e indicando la direzione con un indicatore di direzione svitato. Gli altri indicatori di direzione lampeggeranno allora più rapidamente. (ATTENZIONE: a tal scopo non può essere usata una cassetta da test su cui come carico siano utilizzati esclusivamente LED).

IT

7-poliga kabelsats med C2-modul.

I denna kabelsats tillämpas C2-modulen i stället för ett blinkljusrelä med C2 kontrollampa. En trasig blinkerlampa anges genom att de övriga blinkljusen blinkar snabbt (enligt europeiskt direktiv 76/756/EEC §4.5.8. och StVZO §54).

För att förekomma att C2-modulen överbelastas får på släpvagnen maximalt 21W blinkljus anslutas per sida.

C2-modulens funktion kan testas genom att koppla till en släpvagn (eller ett testskåp) och visa körriktning med en lösskruvad blinkerlampa. De andra blinkljusen blinkar nu snabbt. (OBS: ett testskåp där belastningen endast består av lysdioder kan inte användas för detta.)

SE

7pólóvá elektrická souprava s modulem C2.

C2 modul je v této elektrické soupravě používán místo blikacího relé s čidlem pro selhání světel C2. Vadné směrové světlo vozidla a/nebo obytného přívěsu/návěsu je signalizováno rychlejšími blikáním dalšího směrového světla (v souladu s evropskou směrnicí 76/756/EEC §4.5.8. a StVZO §54).

Aby se zabránilo přetížení modulu C2, na každé straně lze připojit ve směrových světlech maximálně 21 W.

Funkci modulu C2 lze otestovat připojením návěsu/přívěsu (nebo testovacího boxu) a zapnutím směrových světel s jedním světlem vyjmutým. Další směrová světla budou blikat rychleji. (POZOR: v tomto případě nelze použít testovací box, ve kterém se používají pouze LED).

CZ

7-polet ledningsnetsæt med C2-modul.

I dette ledningsnetsæt bruges et C2-modul i stedet for et blinkrelæ med en C2-lyssvigt detektor. Hvis der findes et defekt indikatorlys i bilen og/eller campingvognen og/eller anhængerens vises det ved at det andet indikatorlys blinker hurtigere (i overensstemmelse med det Europæiske direktiv 76/756/EEC § 4.5.8. og StVZO § 54). For at undgå overbelastning af C2-modulet, kan der maksimalt forbindes 21 W indikatorlys i hver side. Funktionen af C2-modulet kan testes ved at forbinde anhænger/campingvognen (eller en testboks) og aktivere indikatorlysen med et indikatorlys aftaget. Det andet indikatorlys skal dermed blinke hurtigere. (BEMÆRK: man kan ikke benytte en testboks der kun har LED's til denne test).

DK

7-napainen kaapelisarja C2-moduuleineen. Tässä kaapelisarjassa C2-moduulia käytetään suuntavilkujen releen asemesta yhdessä C2-merkivalon kanssa.

Viallisesta vilkkulampusta ilmaistaan siten, että muut vilkkuvalot vilkkuvat nopeammin (noudattaen EU:n direktiivin 76/756/EU kohtaa 4.5.8 ja StVZO kohtaa 54).

Välttääkseen C2-moduulin ylikuormittamista perävaunun kummallakin sivulla saa käyttää korkeintaan 21 W vilkkulamppuja.

C2-moduulin toimintoja voi testata perävaunun (tai 21 W lamppuisen testilaite) kanssa, irrottamalla yhden suuntavilkun polttime ja kytkeväällä suuntavilkun päälle.

Muut suuntavilkut alkavat vilkkua nopeammin. (HUOMIO: tähän tarkoitukseen ei saa käyttää testilaite, jonka kuormituksena ovat ainoastaan ledit.)

FI

Συνδέστε τον εξοπλισμό της πλεξούδας καλωδίων 7 πόλων με τη μονάδα C2. Σε αυτό τον εξοπλισμό της πλεξούδας καλωδίων, η μονάδα C2 χρησιμοποιείται αντί του τόξου πορείας ηλεκτρονόμου με έναν λαμπτήρα αισθητήρα σφάλματος C2. Ο ελαττωματικός λαμπτήρας των φλας του αυτοκινήτου ή/και του τροχόσπιτου/ρυμουλκού υποδηλώνεται από ένα πιο γρήγορο αναβοσβήμμα του άλλου λαμπτήρα των οργάνων ένδειξης (Ακολουθώντας τις Ευρωπαϊκές οδηγίες 76/756/EEC §4.5.8. και StVZO §54). Για να αποφύγετε υπερφόρτωση του εξοπλισμού C2, σε κάθε πλευρά μπορεί να συνδεθεί ένα μέγιστο 21W σε λαμπτήρες οργάνων μέτρησης που αναβοσβήνουν. Η λειτουργία του εξοπλισμού C-2 μπορεί να δοκιμαστεί συνδέοντας το ρυμουλκό/τροχόσπιτο (ή ένα κιβώτιο δοκιμής) και ανάβοντας τα φώτα των οργάνων μέτρησης με έναν αφαιρούμενο λαμπτήρα οργάνων ένδειξης. Τα υπόλοιπα φώτα στα όργανα ένδειξης θα αναβοσβήνουν πιο γρήγορα. (ΠΡΟΣΟΧΗ: το κιβώτιο δοκιμής στο οποίο χρησιμοποιούνται μόνο LED, δεν μπορεί να χρησιμοποιηθεί σε αυτή την περίπτωση).

GR

7-pols kabelsett med C2-modul.

I dette kabelsettet tilpasses C2-modulen i stedet for blinklysrelé med C2-kontrolllys. Et defekt blinklys vises ved at de øvrige blinklysene blinker raskt (i h. t. europeisk direktiv 75/756/EEC §4.5.8 og StVZO §54).

For å hindre overbelastning av C2-modulen kan maksimum 21W blinklys per side tilkobles tilhengeren.

Effekten av C2-modulen kan testes ved å koble til en tilhenger (eller testskap) og indikere retning med et løsskrudd blinklys. De andre blinklysene skal nå blinke hurtig. (NB: Et testskap der belastningen kun består av lysdioder kan ikke brukes til dette.)

NO

7-stykowy zestaw okablowania z modulem C2. W tym zestawie używany jest moduł C2 zamiast przerywacza z czujnikiem awarii światła C2. Uszkodzone światło wskaźnika w pojeździe/przyczepie jest sygnalizowane przez szybsze pulsowanie drugiego wskaźnika (zgodnie z dyrektywą europejską 76/756/EEC §4.5.8. oraz StVZO §54). W celu uniknięcia przeciążenia modułu C2 z każdej strony można podłączyć maksymalnie 21W obciążenie. Działanie modułu C2 można przetestować przez podłączenie przyczepty (lub testera) i włączenie wskaźników przy wyjętej lampce wskaźnika. Pozostałe lampki wskaźnika będą pulsować szybciej. (PRZESTROGA: w tym przypadku nie można używać testera w którym używane są tylko diody LED).

PL

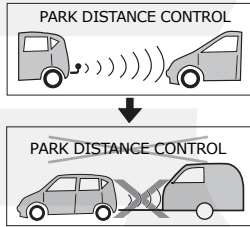
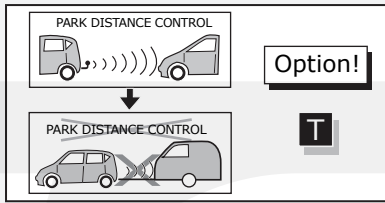

? Info

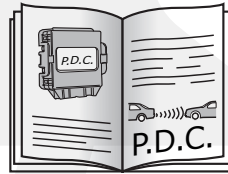

Option 1: NC

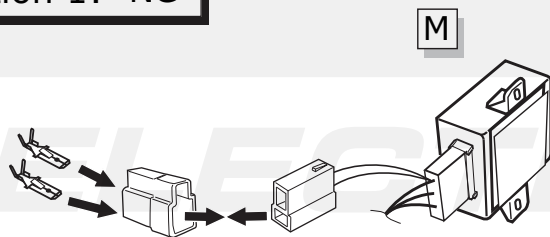

NC

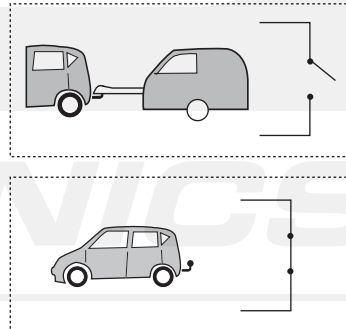

Option 2: NO

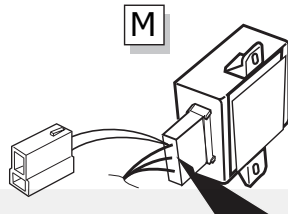

1

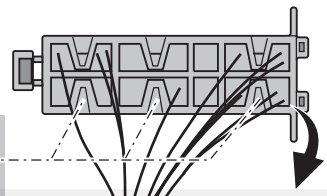
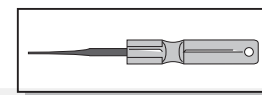

3

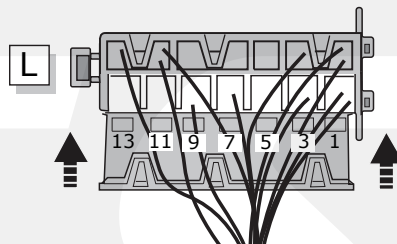

4

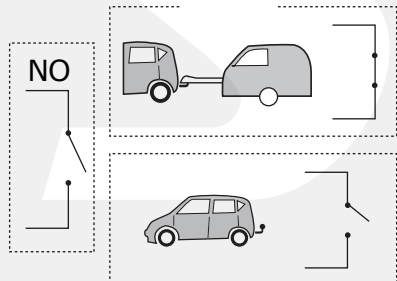

5

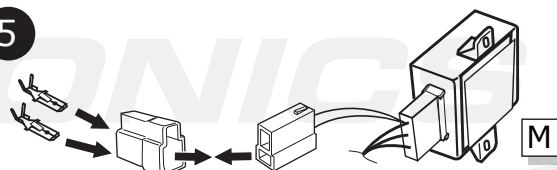



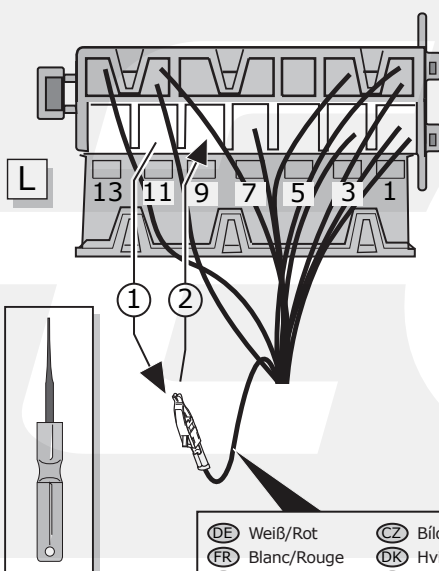



2

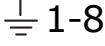

DE Weiß/Rot	CZ Bílo/Červená
FR Blanc/Rouge	DK Hvid/Rød
NL Wit/Rood	FI Valkoinen/Punainen
GB White/Red	GR Λευκό/Κόκκινο
ES Blanco/Rojo	NO Hvit/Rød
IT Bianco/Rosso	PL Biały/Czerwony
SE Vit/Röd	

Pin 11 → Pin 9

- (DE) Anschluss Steckdose
- (FR) Connection de la prise
- (NL) Contactdoos aansluiting
- (GB) Socket connection
- (ES) Conexión de la caja de enchufe
- (IT) Allaccio zoccolo
- (SE) Anslutning kontaktdosa
- (CZ) Objímkový konektor
- (DK) Stikdåse forbindelse
- (FI) Pistorasia liitäntä
- (GR) Υποδοχή σύνδεσης
- (NO) Tilkobling koblingsboks
- (PL) Połączenie przez gniazdo

DIN/ISO 1724							
	1/L	2	3/31	4/R	5/58-R	6/54	7/58-L
Pmax	21W	2x21W		21W	52W	3x21W	52W
(DE)	Gelb	Blau	Weiß	Grün	Braun	Rot	Schwarz
(FR)	Jaune	Bleu	Blanc	Vert	Marron	Rouge	Noir
(NL)	Geel	Blaauw	Wit	Groen	Bruin	Rood	Zwart
(GB)	Yellow	Blue	White	Green	Brown	Red	Black
(ES)	Amarillo	Azul	Blanco	Verde	Marrón	Rojo	Negro
(IT)	Giallo	Blu	Bianco	Verde	Marrone	Rosso	Nero
(SE)	Gul	Blå	Vit	Grön	Brun	Röd	Svart
(CZ)	Žlutá	Modrá	Bílá	Zelená	Hnědá	Červená	Černá
(DK)	Gul	Blå	Hvid	Grøn	Brun	Rød	Sort
(FI)	Keltainen	Sininen	Valkoinen	Vihreä	Ruskea	Punainen	Musta
(GR)	Κίτρινο	Μπλε	Λευκό	Πράσινο	Καφέ	Κόκκινο	Μαύρο
(NO)	Gul	Blå	Hvit	Grønn	Brun	Rød	Svart
(PL)	Żółty	Niebieski	Biały	Zielony	Brązowy	Czerwony	Czarny