

## Ford Focus Hatchback 12/2007-

Partnr.: FR-041-JH

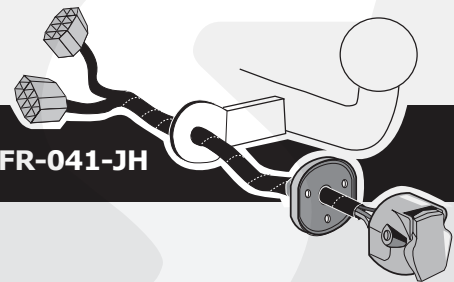

**DE** Einbauanleitung Elektrosatz Anhängervorrichtung mit 13-P Steckdose lt. DIN/ISO Norm 11446

**FR** Instructions de montage du faisceau électrique pour crochet d'attelage conforme à la norme DIN/ISO 11446 prise 13-V.

**NL** Montage-handleiding elektrokabelset voor trekhaak met 13-P contactdoos vlg. DIN/ISO norm 11446.

**GB** Fitting instructions electric wiring kit tow bar with 13-P socket up to DIN/ISO Norm 11446.

**ES** Instrucciones de montaje de kit eléctrico para engancho de remolque con caja de conexiones 13-P según norma DIN/ISO 11446.

**IT** Istruzioni di montaggio di set di cavi elettrici per gancio da traino con zoccolo a 13-P conforme alla norma DIN/ISO 11446.

**SE** Monteringsanvisningar elkabelsats för dragkrok med 13-P kontaktdosa enligt DIN/ISO norm 11446.

**CZ** Montážní pokyny: souprava pro elektrické propojení tažné tyče s 13-P zásuvkou do normy DIN/ISO 11446.

**DK** Monteringsvejledninger for det elektriske ledningsføringssæt for trækstang med 13-N stikdåse, DIN/ISO, norm 11446.

**FI** Ohjeet vetokoukun sähkökaapelisarjan asentamiseen, jossa on DIN/ISO 11446 mukainen 13-N liitin.

**GR** Οδηγίες συναρμολόγησης ηλεκτρικού σετ καλωδίων μπάρας ρυμούλκησης με υποδοχή 13-P μέχρι DIN/ISO Κανόνας 11446.

**NO** Monteringsanviser elkabelsett for trekrok med 13-P koblingsboks ifølge DIN/ISO norm 11446.

**PL** Instrukcje montażu zestawu okablowania elektrycznego dyszla holowniczego z 13-stykowym gniazdem DIN/ISO 11446.

**DE** - Wir weisen ausdrücklich darauf hin, dass eine unsachgemäße und nicht in einer Fachwerkstatt durchgeführte Montage einen Verzicht auf Entschädigung jeglicher Art insbesondere bezüglich des Produkthaftpflichtrechts zur Folge hat

**FR** - Il est expressément prévu qu' on ne saurait se prévaloir d'un quelconque préjudice contractuel ou réhibitoire si le montage avait été fait en dépit des dites instructions ou dans un garage ne disposant pas des équipements adéquats.

**NL** - Wij wijzen er met nadruk op, dat ondeskundige en niet door een vakkundige werkplaats uitgevoerde montage tot gevolg heeft dat daardoor ieder recht op schadevergoeding, ook op wettelijke aansprakelijkheid inzake producten, vervalt.

**GB** - We would expressly point out that assembly not carried out properly by a competent installer will result in cancellation of any right to damage compensation, in particular those arising by virtue of the product liability act.

**ES** - El montaje inapropiado y efectuado por personal no cualificado originará la pérdida de todo derecho a indemnización o la expiración de toda responsabilidad civil con respecto al producto.

**IT** - Sottolineiamo espressamente che un montaggio inadeguato ed eseguito da un'officina non specializzata ha come conseguenza il decadere di qualsiasi diritto al risarcimento danni, nonché alla responsabilità legale relativa ai prodotti.

**SE** - Vi påpekar med eftertryck att all rätt till skadeersättning och all laglig ansvarighet förfaller om monteringen inte har utförts på rätt sätt och av en professionell verkstad.

**CZ** - Výslovně zdůrazňujeme, že jakákoli montáž, která není provedená ve specializované dílně, má za následek odvolání nároků na kompenzaci jakéhokoliv druhu, obzvláště vyplývajících ze zákona o odpovědnosti za způsobené škody.

**DK** - Vi ønsker at gøre udtrykkeligt opmærksom på at forkert samling, der ikke er udført af et specialiseret værksted, resulterer i bortfaldelse af kompenseringskrav af alle slags, i særdeles krav der måtte opstå omkring det lovpligtige ansvar.

**FI** - Korostamme, että kaikki oikeudet vahinkokorvaukseen kuten myös valmistajan laillinen vastuu raukeavatt, mikäli asennusta ei ole toteutettu oikealla tavalla eikä ammattitaitoisen asiantuntijan toimesta.

**GR** - Επισημαίνουμε κατηγορηματικά ότι οποιαδήποτε εσφαλμένη συναρμολόγηση, η οποία δεν έχει πραγματοποιηθεί ειδικό εργαστήριο θα οδηγήσει σε απονομή των αξιώσεων επιβολής αποζημιώσεων οποιαδήποτε είδους, ειδικά όσα προκύπτουν από το νόμο ευθύνης προϊόντων.

**NO** - Vi påpeker ettertrykkelig at all rett til skadeerstatning og rettslig ansvar forfaller dersom monteringen ikke er blitt utført på riktig måte og av et profesjonelt verksted.

**PL** - Chcielibyśmy wyraźnie zaznaczyć, iż wszelki nieprawidłowy montaż, który nie jest wykonywany w specjalistycznym warsztacie pociąga za sobą utratę możliwości dochodzenia wszelkiego typu roszczeń, w szczególności tych wynikających z odpowiedzialności producenta za swój produkt.

- Technische Änderungen vorbehalten.

- Widerstand nur gemäß der Tabelle auf dem Anhänger verwenden, siehe Seite 12.

- Sous réserve de modifications techniques.

- Ne excédez pas la charge maximale, indiquée dans le tableau sur page 12.

- Technische wijzigingen voorbehouden.

- Gebruik alleen belasting volgens aansluittabel op het getrokken voertuig, zie pagina 12.

- Contents of these kits and their fitting manuals are subject to alteration without notice, please ensure that these instructions are read and fully understood before commencing installation.

- Do not overload circuits; the maximum loads per connection are detailed in this manual.

- Nos reservamos el derecho a efectuar modificaciones técnicas.

- Utilice sólo cargas de acuerdo a la tabla de conexión del vehículo remolcado (ver página 12).

- Ci si riserva il diritto di apportare modifiche tecniche.

- Utilizzare esclusivamente un carico conforme alla tabella degli allacci relativa al veicolo in questione, cfr. pagina 12.

- Tekniska ändringar förbehålles.

- Använd endast belastning enligt anslutningstabellen på det dragna fordonet, se sid. 12.

- Změny mohou být provedeny bez oznámení.

- Používejte pouze při maximálním nabití podle tabulky na tažném vozidle, viz. str. 12.

- Kan ændres uden varsel.

- Brug kun den maksimale belastning, i overensstemmelse med forbindelsestabelen for bugserede køretøjer, side 12.

- Oikeus teknisiin muutoksiin ilman erillistä huomautusta pidetään.

- Kuormita työvirtapiiriä ainoastaan hinattavan ajoneuvon kytkentäkaavion mukaisesti, katso sivu 12.

- Μπορεί να τροποποιηθεί χωρίς προηγούμενη ειδοποίηση.

- Χρησιμοποιείτε μόνο μέγιστο ηλεκτρικό φορτίο σύμφωνα με τον πίνακα σύνδεσης στο ρυμούλκούμενο όχημα, δείτε σελίδα 12.

- Tekniske endringer forbeholdes. - Overskrid ikke grensene anvist i tilkoblingstabellen på tilhengeren eller det tilkoblede kjøretøyet, se s. 12.

- Podlega zmianom bez powiadomienia.

- Używać tylko takiego maksymalnego obciążenia które wynika z tabliczki połączeń holowanego pojazdu, patrz strona 12.

Einzelteiliste

Liste de pièces

Onderdelenlijst

Part list

Lista de componentes

Elenco componenti

Dellista

Seznam dílů

Del-liste

Osaluettelo

Κατάλογος εξαρτημάτων

Delliste

Lista części

DE

FR

NL

GB

ES

IT

SE

CZ

DK

FI

GR

NO

PL

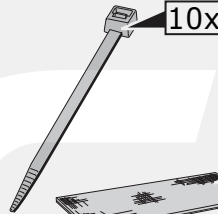
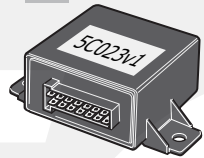
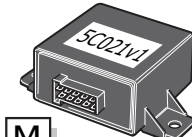
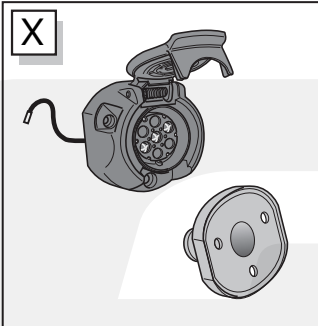
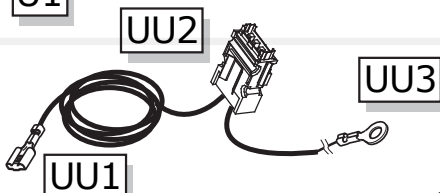
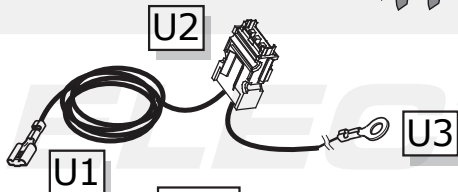
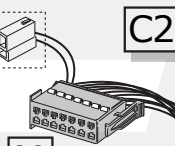
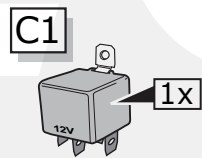
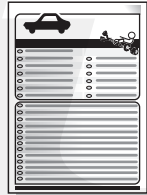
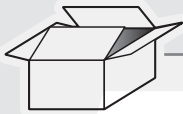

Option! \*

↓

Pag. 11

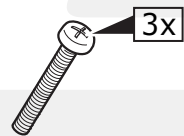

Option!

Pag. 11

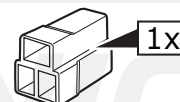
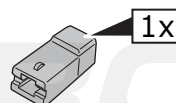

**ROUTING**

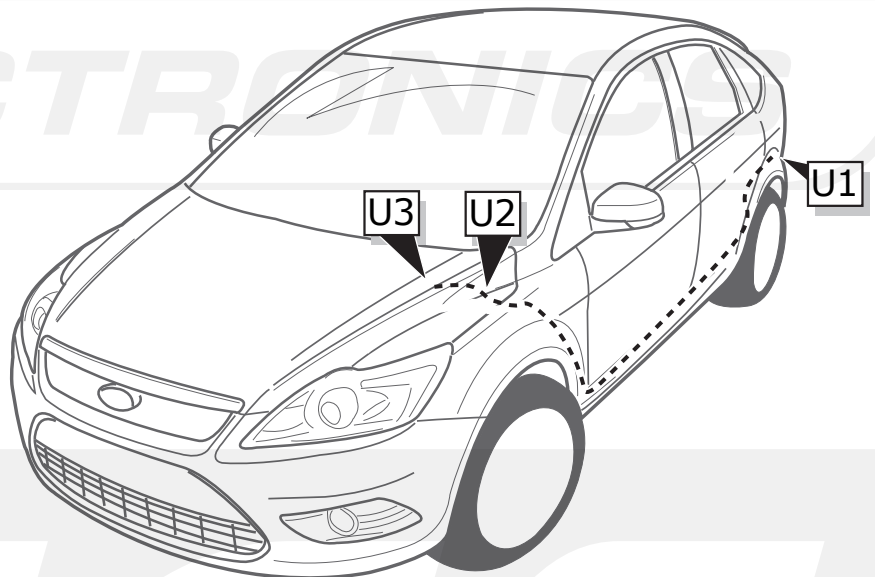
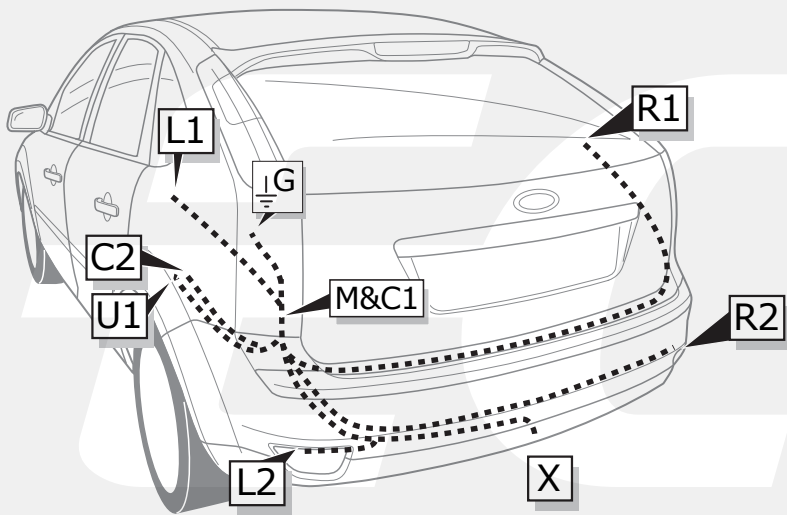

**1**

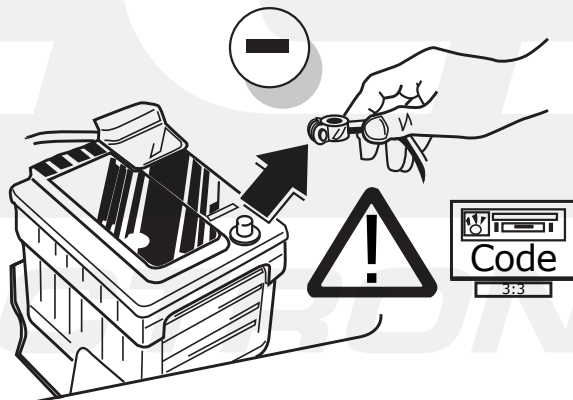

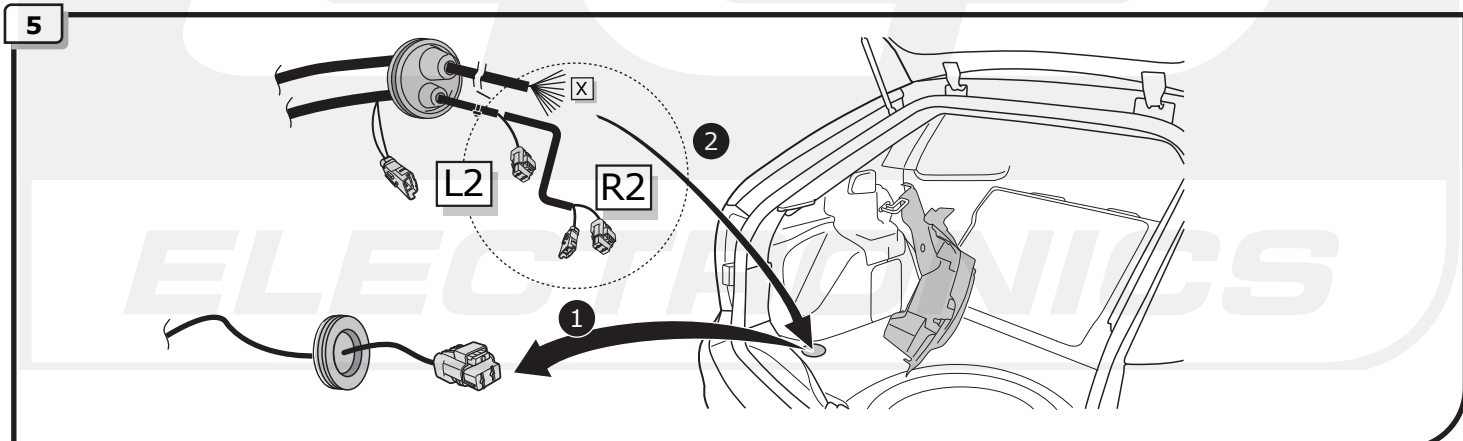
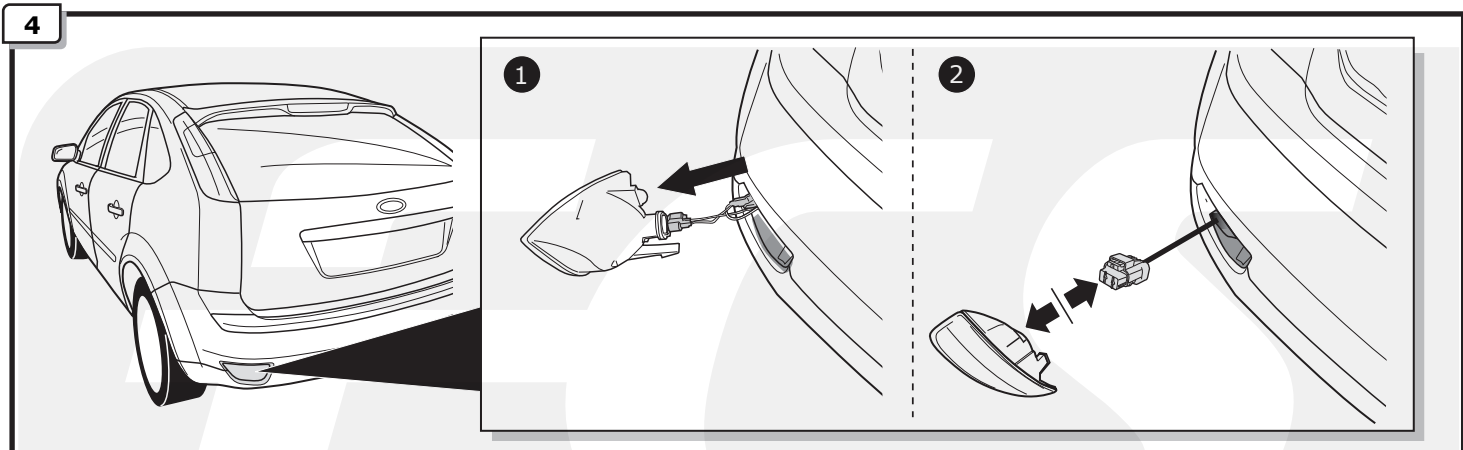
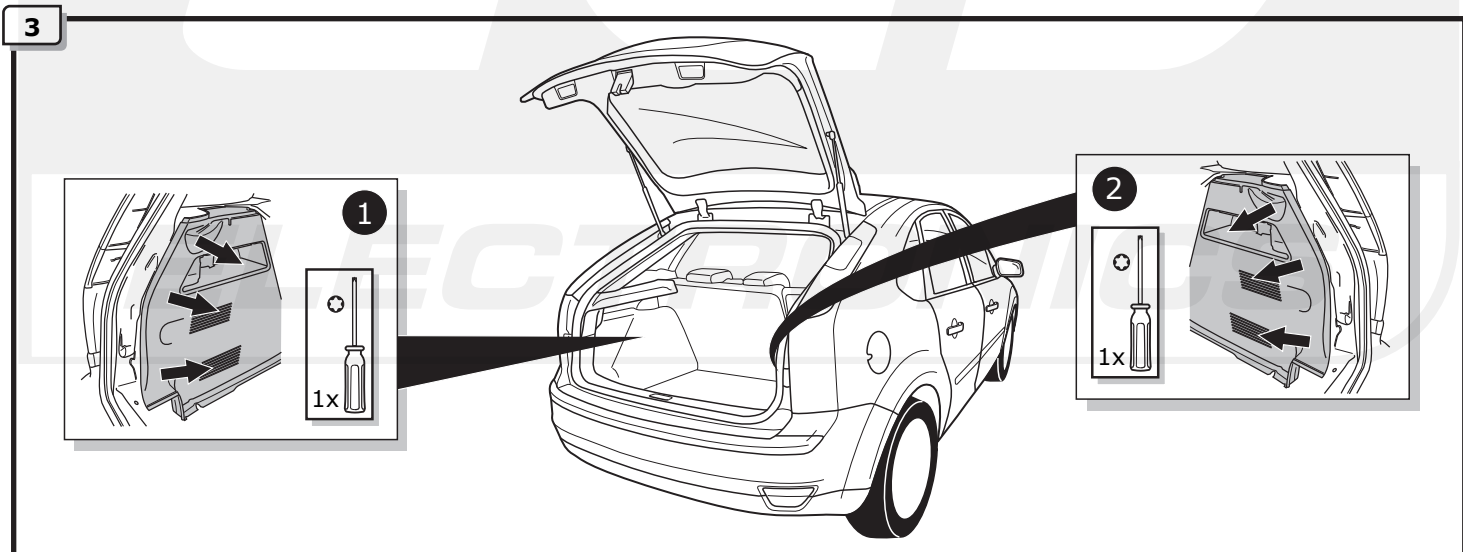
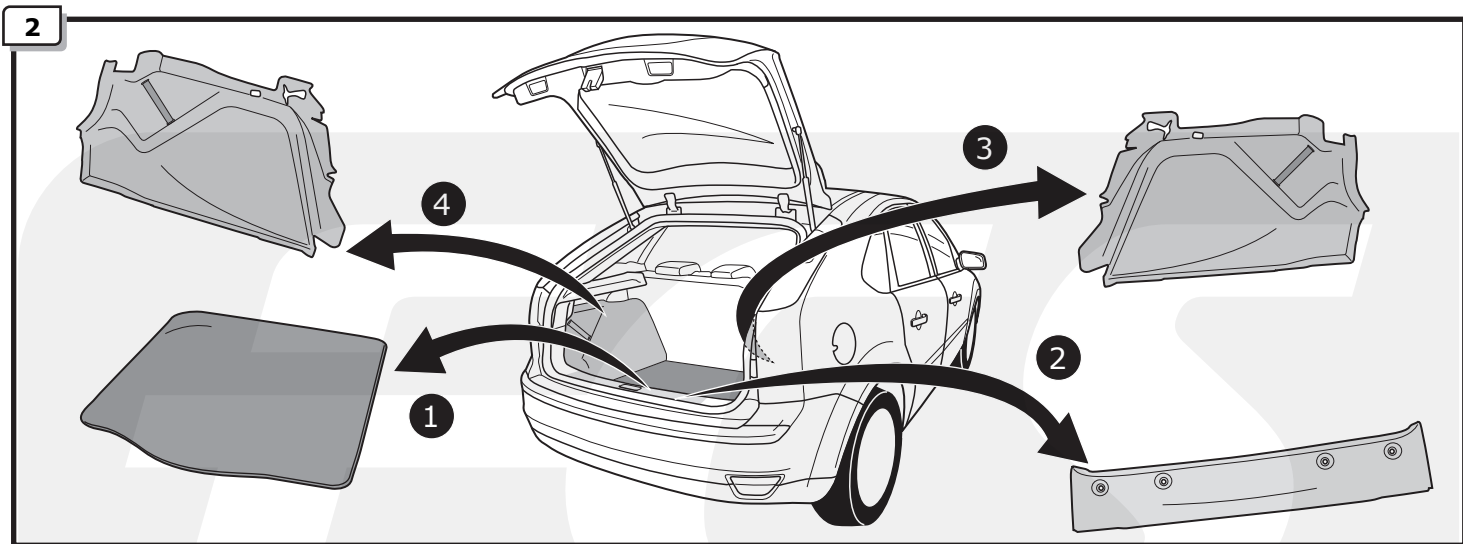

A

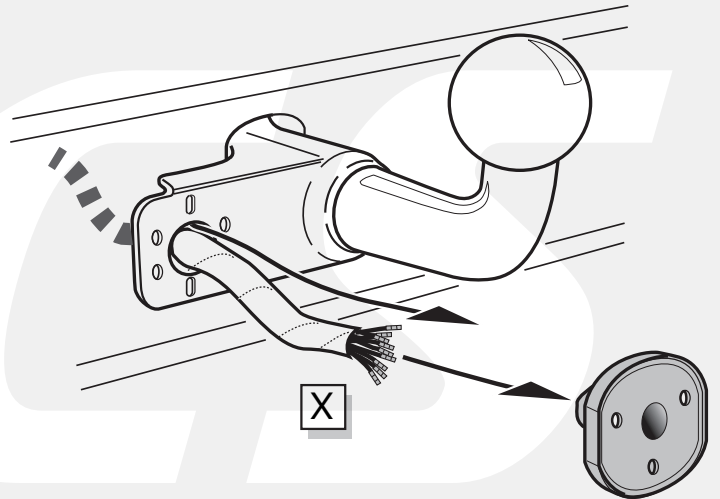
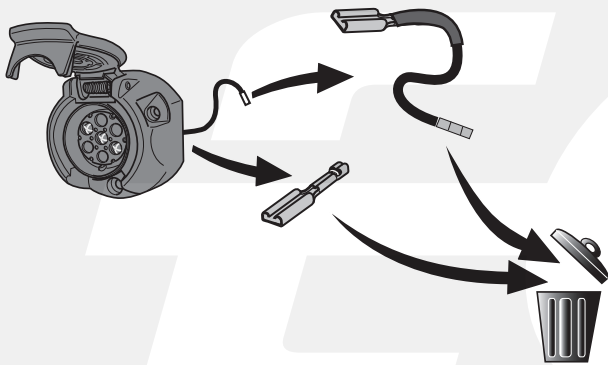

## INFO

- ⓁⒹ Anschluss Steckdose
- ⓁⒻ Connection de la prise
- ⓁⒼ Contactdoos aansluiting
- ⓁⒼ Socket connection
- ⓁⒺ Conexión de la caja de enchufe
- ⓁⒽ Allaccio zoccolo

- ⓁⒺ Anslutning kontaktdosa
- ⓁⒻ Objímkový konektor
- ⓁⒼ Stikdåse forbindelse
- ⓁⒻ Pistorasia liitântä
- ⓁⒼ Υποδοχή σύνδεσης
- ⓁⒼ Tilkobling koblingsboks
- ⓁⒼ Połączenie przez gniazdo



Pag. 12

B

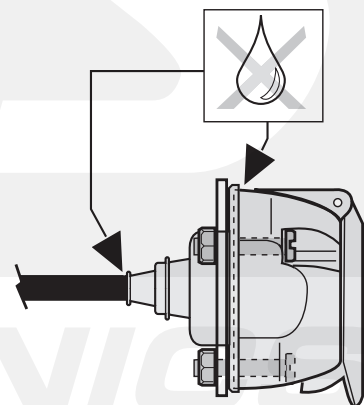
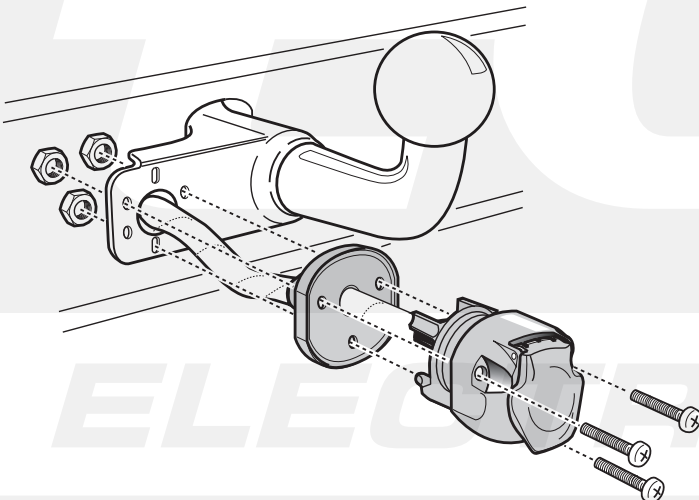



6



7

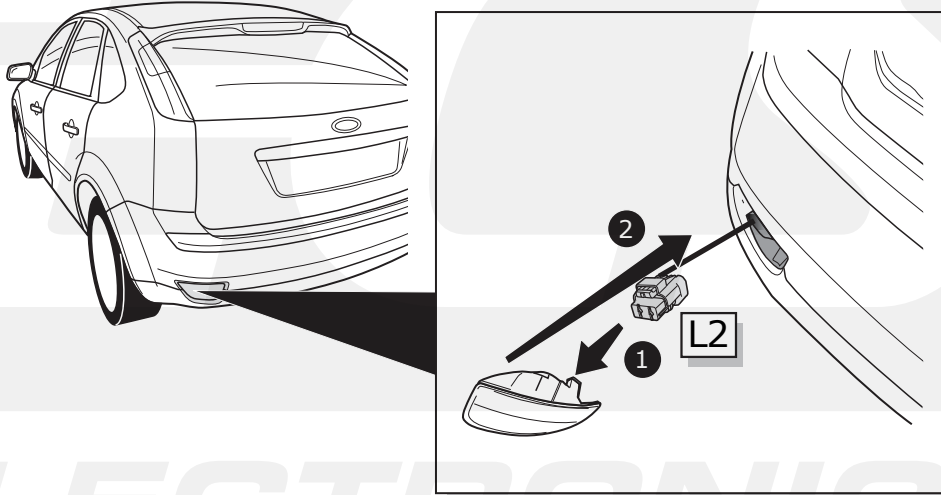

8

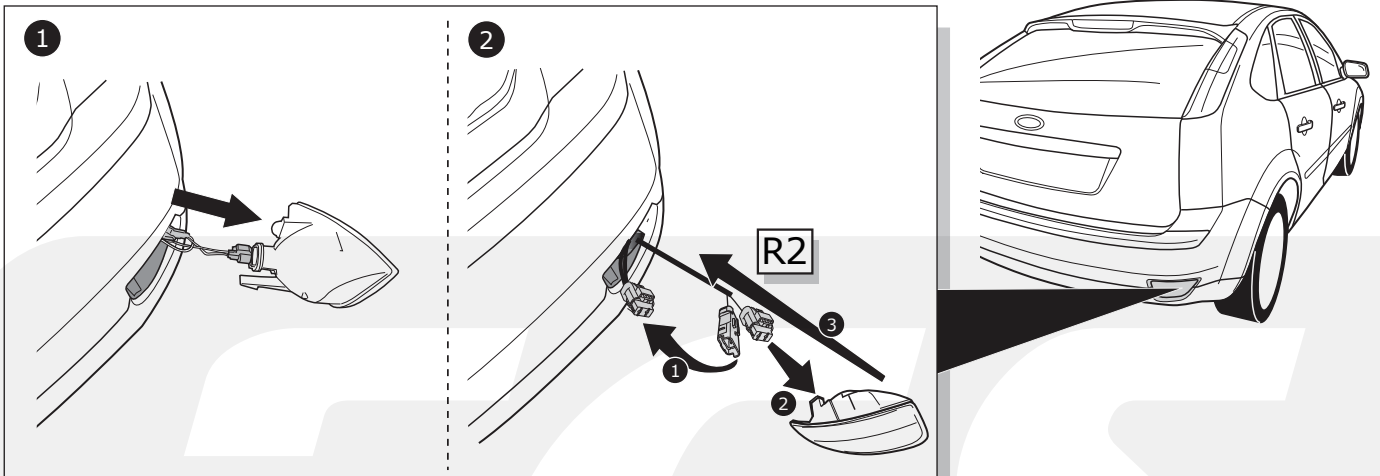

9

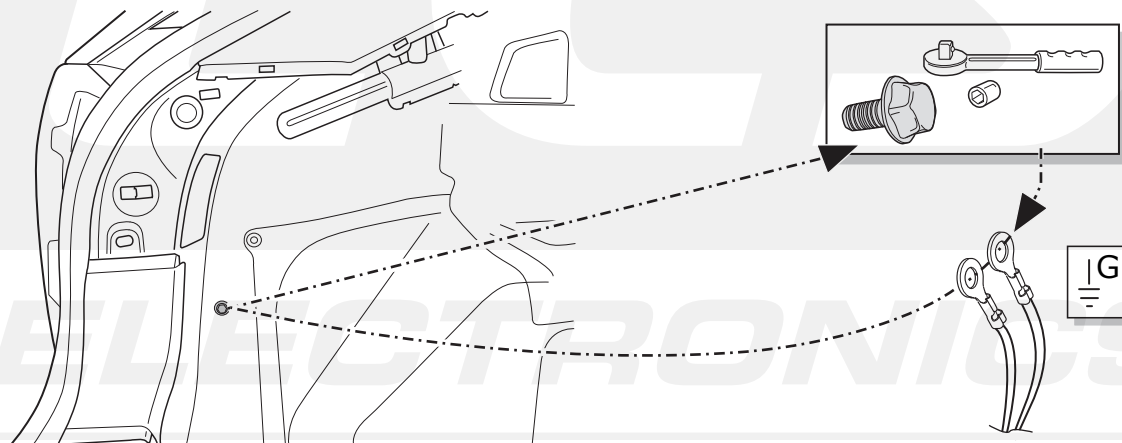

10

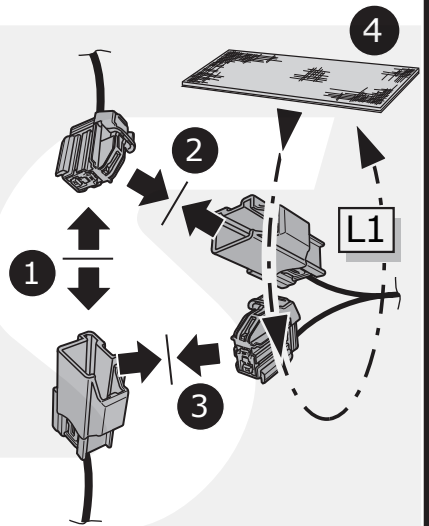
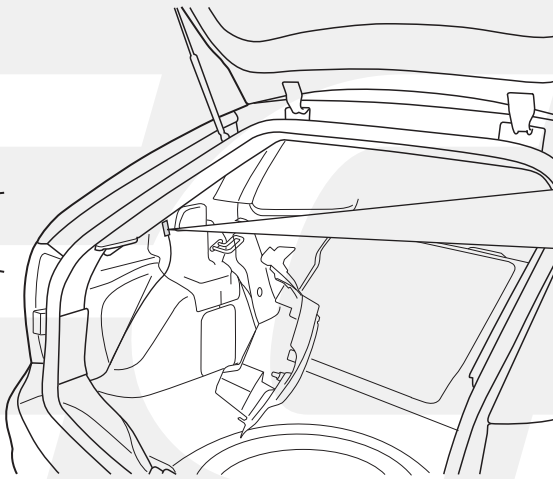
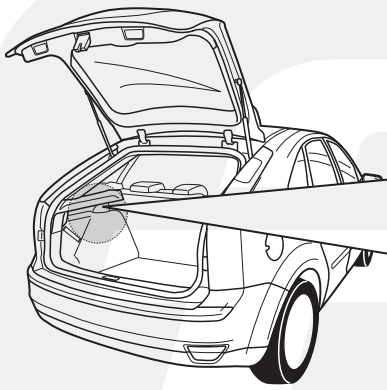

11

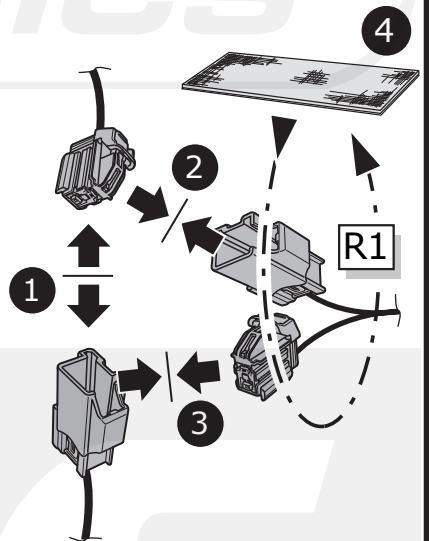
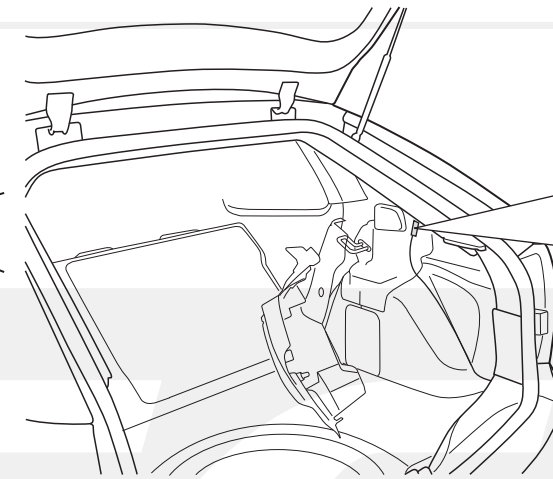
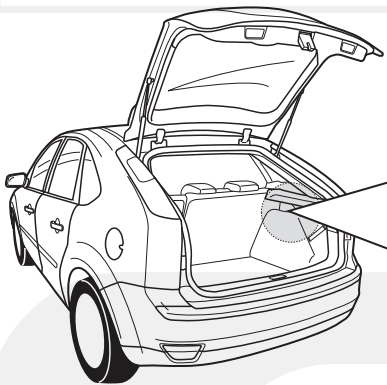

12

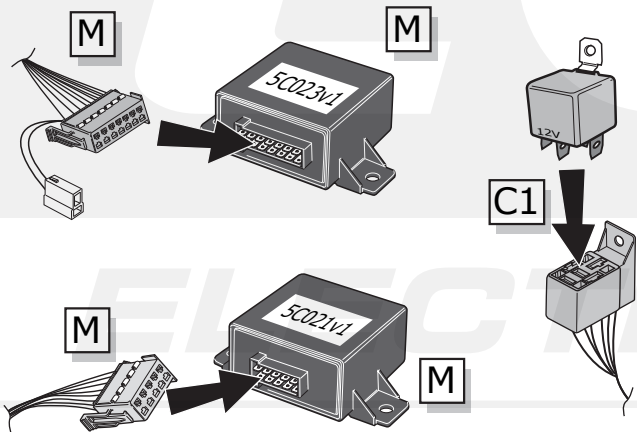

13

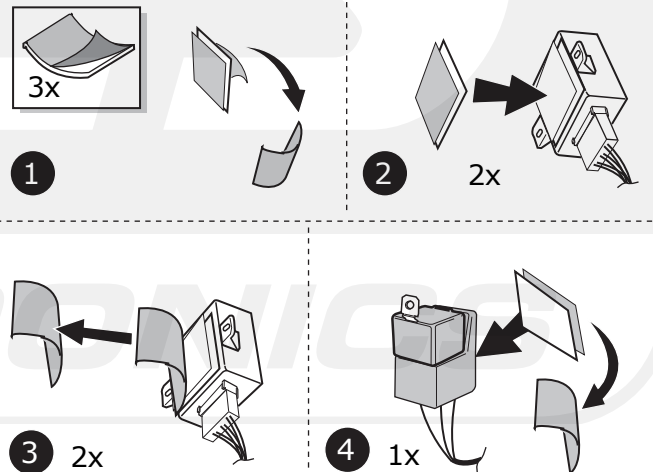

14

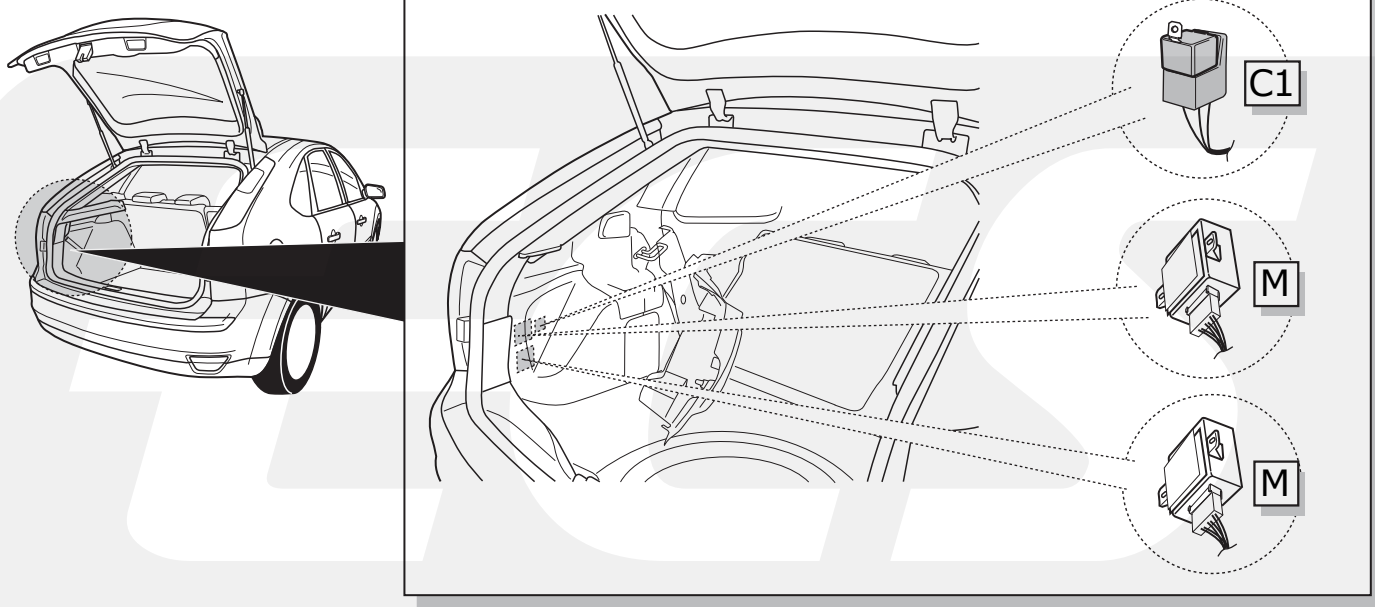

15

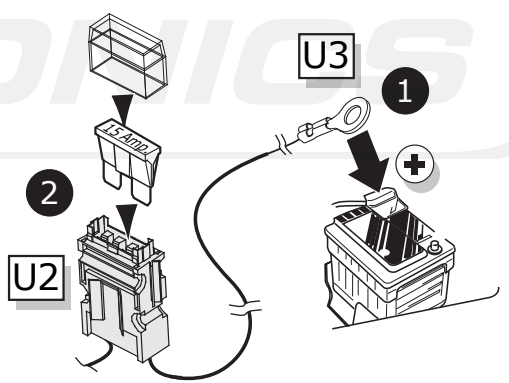
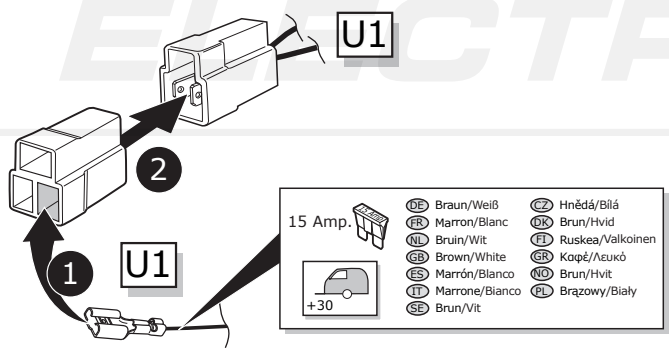

16a

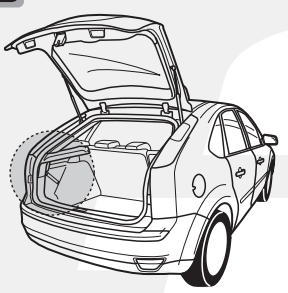

**Option 1**

→ 09/2005

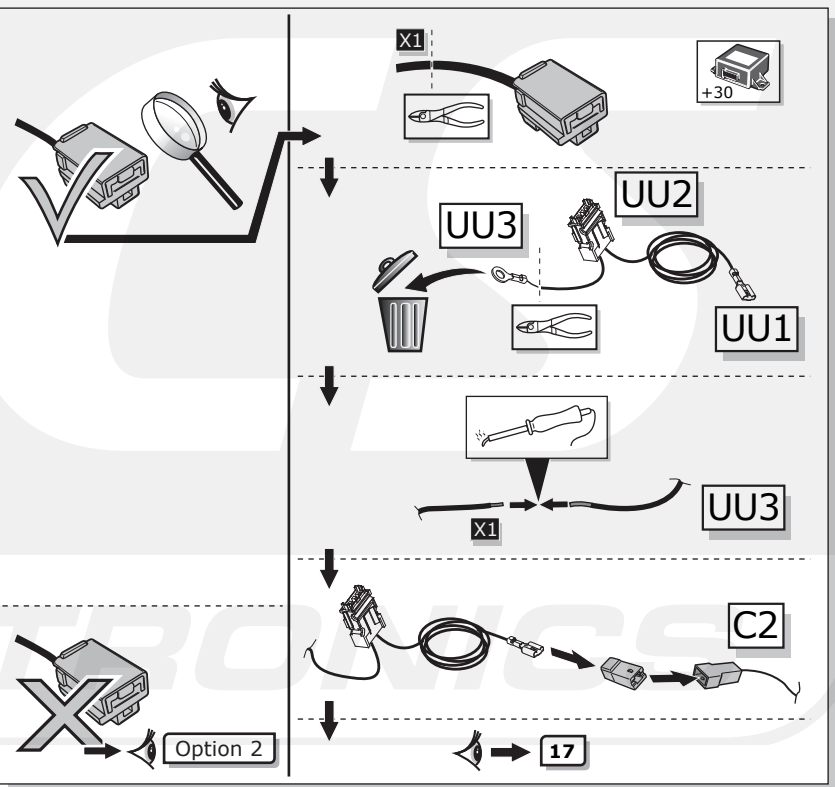



16b



Option 2

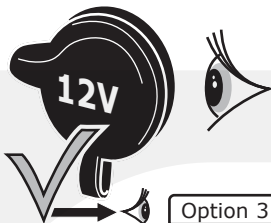

Option 3

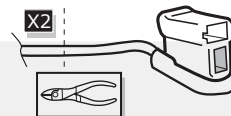
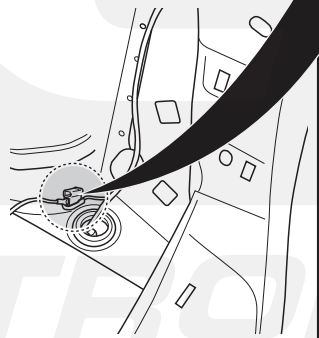

UU3

UU2

UU1

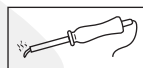

UU3

X2

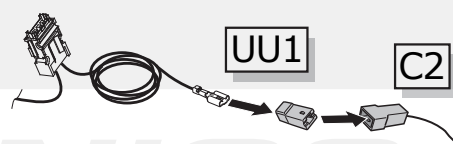

UU1

C2



16c

Option 3

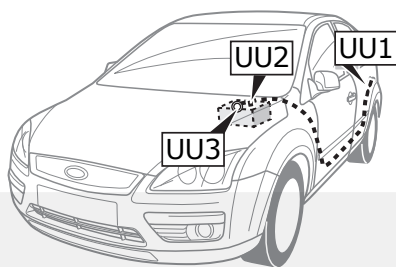

15 Amp. +30	DE Orange	CZ Oranžová
	FR Orange	DK Orange
	NL Oranje	FI Oranssi
	GB Orange	GR Πορτοκαλί
	ES Naranja	NO Oransje
	IT Arancione	PL Pomarańczowy
	SE Orange	

UU1

1

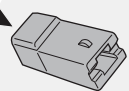

2

C2



UU3

1

2

UU2

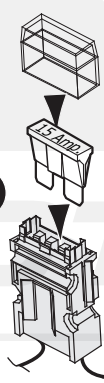

+



17

17

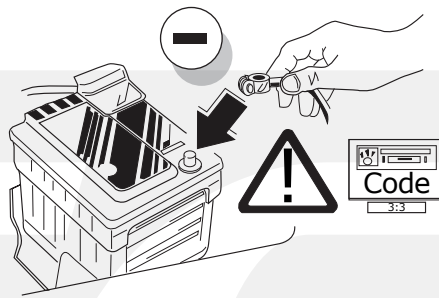

18

- DE** FUNKTIONEN KONTROLLIEREN MIT EINEM PRÜFGERÄT MIT WIDERSTAND ODER MIT LEUCHTEN MIT DER GENAUEN WATTZAHL!
- FR** CONTRÔLER LES FONCTIONS AVEC UNE BOÎTE DE TEST AVEC DE LA CHARGE OU DES LAMPES AVEC LA QUANTITÉ CORRECTE DE WATT!
- NL** CONTROLEER FUNCTIES MET EEN TESTER MET BELASTING OF LAMPEN MET DE JUISTE WATTAGE!
- GB** TEST ALL CIRCUIT FUNCTIONS WITH A TESTBOX WITH THE CORRECT POWER LOAD FOR EACH UNIT. A TESTBOX ON WHICH ONLY LEDs ARE USED CAN NOT BE USED IN THIS CASE
- ES** ¡CONTROLEAR FUNCIONES CON UN TESTER CON CARGA O LUCES CON EL CORRECTO WATTAJE!
- IT** CONTROLLA FUNZIONI CON UN TESTER CON CARICO O LAMPADE DEL GIUSTO WATT-TAGGIO!
- SE** KONTROLLERA FUNKTIONERNA MED EN TESTARE MED BELASTNING ELLER LAMPOR MED RÄTT WATT-VÄRDE!
- CZ** OVĚŘTE FUNKCE POMOČÍ TESTOVACÍHO BOXU NEBO SVĚTEL S PŘÍSLUŠNÝM VÝKONEM!
- DK** CHECK FUNKTIONERNE MED EN TESTBOKS, MED BELASTNING ELLER MED LYGTER MED DET KORREKTE ANTAL WATT!
- FI** TARKISTA TOIMINNOT KÄYTTÄMÄLLÄ TESTILAITE, JOSSA ON OIKEATEHOINEN KUORMITUS TAI OIKEATEHOISET LAMPUT!
- GR** ΕΛΕΓΞΤΕ ΤΙΣ ΛΕΙΤΟΥΡΓΙΕΣ ΜΕ ΈΝΑ ΚΙΒΩΤΙΟ ΔΟΚΙΜΗΣ ΜΕ ΦΟΡΤΙΟ Ή ΛΑΜΠΤΗΡΕΣ ΣΩΣΤΗΣ ΠΟΣΟΤΗΤΑΣ ΒΑΤ!
- NO** KONTROLER FUNKSJONENE MED EN TESTER MED BELASTNING ELLER LYSÆRER MED RIKTIG WATTVERDI!
- PL** SPRAWDŹ FUNKCJE UŻYWAJĄC SKRZYŃKI TESTOWEJ Z OBCIĄŻENIEM LUB PODŁĄCZONYMI ŻARÓWKAMI O ODPOWIEDNIEJ MOCY!

19

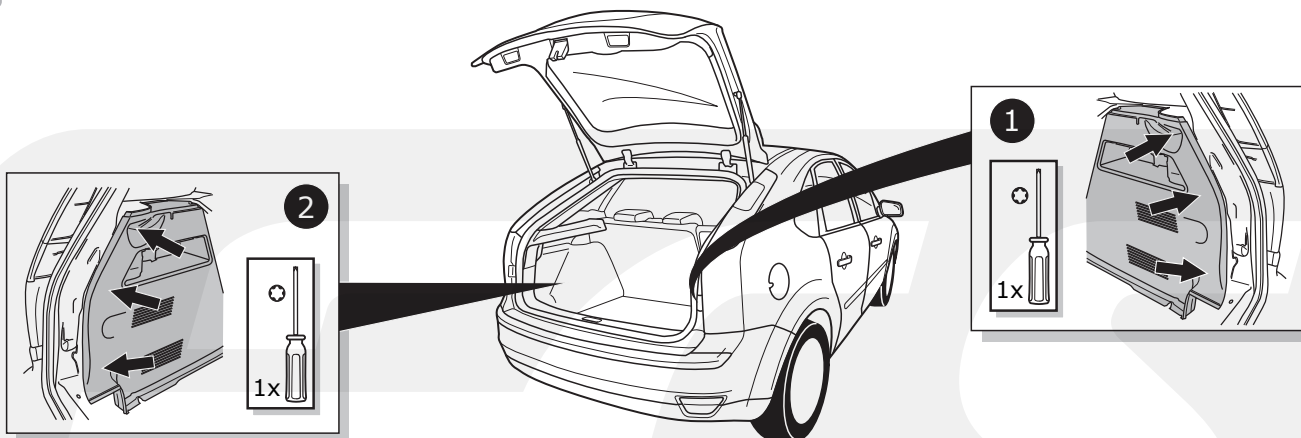

20

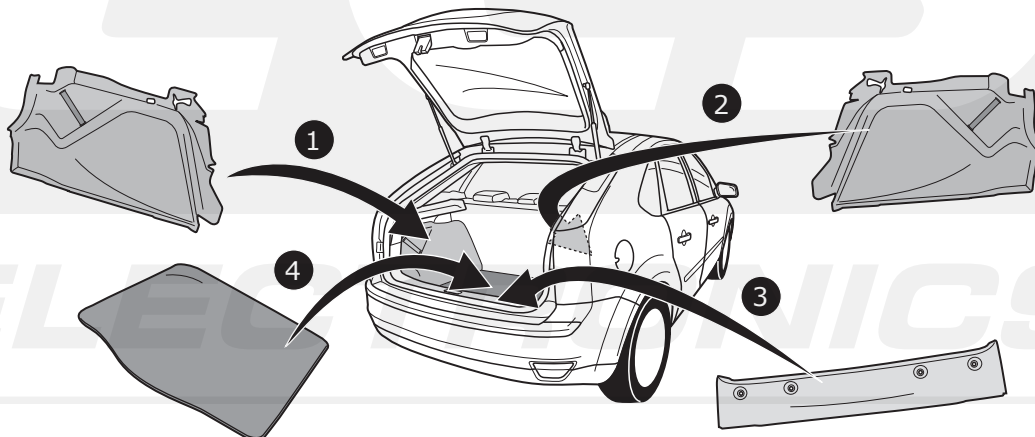

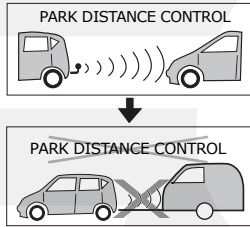
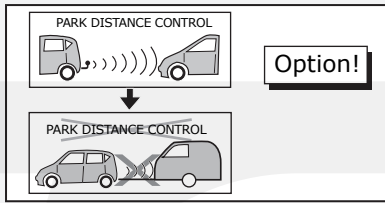

? Info

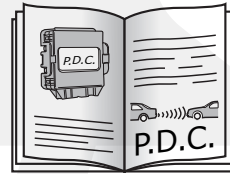

Option 1: NC

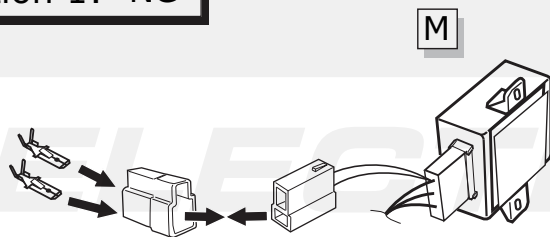

NC

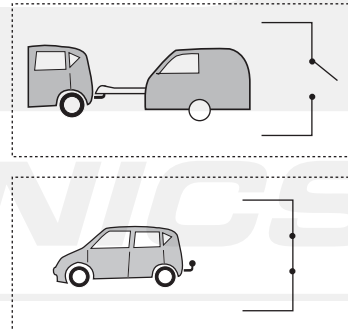

Option 2: NO

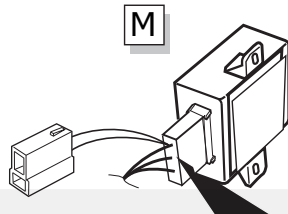

1



2

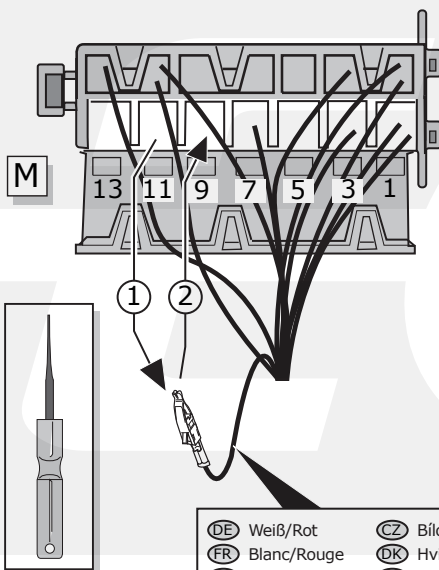

3

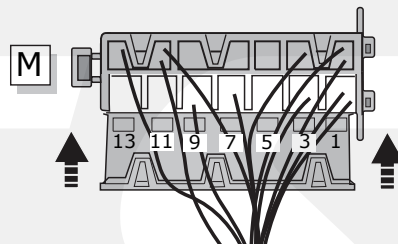

4

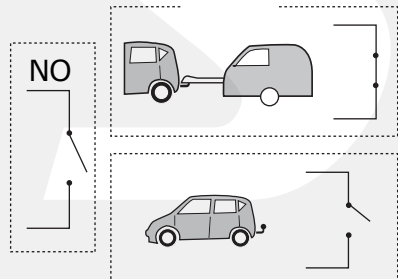

5

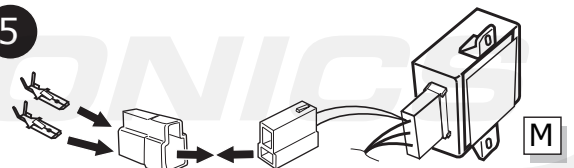







DE	Weiß/Rot	CZ	Bílý/Červená
FR	Blanc/Rouge	DK	Hvid/Rød
NL	Wit/Rood	FI	Valkoinen/Punainen
GB	White/Red	GR	Λευκό/Κόκκινο
ES	Blanco/Rojo	NO	Hvit/Rød
IT	Bianco/Rosso	PL	Biały/Czerwony
SE	Vit/Röd		

Pin 11 → Pin 9

(DE) Anschluss Steckdose  
 (FR) Connection de la prise  
 (NL) Contactdoos aansluiting  
 (GB) Socket connection

(ES) Conexión de la caja de enchufe  
 (IT) Allaccio zoccolo  
 (SE) Anslutning kontaktdosa

(CZ) Objímkový konektor  
 (DK) Stikdåse forbindelse  
 (FI) Pistorasia liitäntä  
 (GR) Υποδοχή σύνδεσης  
 (NO) Tilkobling koblingsboks  
 (PL) Połączenie przez gniazdo

DIN/ISO 11446	↔		≡ 1-8	↕				Reverse 			≡ 10	—	≡ 9
Pmax	1/L	2	3/31	4/R	5/58-R	6/54	7/58-L	8	9	10	11	12	13
	21W	2x21W	21W	21W	52W	3x21W	52W	2x21W	180W/15Amp.	180W/15Amp.			
(DE)	Gelb	Blau	Weiß	Grün	Braun	Rot (1,00mm <sup>2</sup> )	Schwarz	Schwarz/ Rot	Braun/ Weiß	Rot (2,50mm <sup>2</sup> )	Weiß	Rot/ Blau	Weiß
(FR)	Jaune	Bleu	Blanc	Vert	Marron	Rouge (1,00mm <sup>2</sup> )	Noir	Noir/ Rouge	Marron/ Blanc	Rouge (2,50mm <sup>2</sup> )	Blanc	Rouge/ Bleu	Blanc
(NL)	Geel	Blaauw	Wit	Groen	Bruin	Rood (1,00mm <sup>2</sup> )	Zwart	Zwart/ Rood	Bruin/ Wit	Rood (2,50mm <sup>2</sup> )	Wit	Rood/ Blauw	Wit
(GB)	Yellow	Blue	White	Green	Brown	Red (1,00mm <sup>2</sup> )	Black	Black/ Red	Brown/ White	Red (2,50mm <sup>2</sup> )	White	Red/ Blue	White
(ES)	Amarillo	Azul	Blanco	Verde	Marrón	Rojo (1,00mm <sup>2</sup> )	Negro	Negro/ Rojo	Marrón/ Blanco	Rojo (2,50mm <sup>2</sup> )	Blanco	Rojo/ Azul	Blanco
(IT)	Giallo	Blu	Bianco	Verde	Marrone	Rosso (1,00mm <sup>2</sup> )	Nero	Nero/ Rosso	Marrone/ Bianco	Rosso (2,50mm <sup>2</sup> )	Bianco	Rosso/ Blu	Bianco
(SE)	Gul	Blå	Vit	Grön	Brun	Röd (1,00mm <sup>2</sup> )	Svart	Svart/ Röd	Brun/ Vit	Röd (2,50mm <sup>2</sup> )	Vit	Röd/ Blå	Vit
(CZ)	Žlutá	Modrá	Bílá	Zelená	Hnědá	Červená (1,00mm <sup>2</sup> )	Černá	Černo/ Červená	Hnědo/ Bílá	Červená (2,50mm <sup>2</sup> )	Bílá	Červeno/ Modrá	Bílá
(DK)	Gul	Blå	Hvid	Grøn	Brun	Rød (1,00mm <sup>2</sup> )	Sort	Sort/ Rød	Brun/ Hvid	Rød (2,50mm <sup>2</sup> )	Hvid	Rød/ Blå	Hvid
(FI)	keltainen	Sininen	Valkoinen	Vihreä	Ruskea	Punainen (1,00mm <sup>2</sup> )	Musta	Musta/ Punainen	Ruskea/ Valkoinen	Punainen (2,50mm <sup>2</sup> )	Valkoinen	Punainen/ Sininen	Valkoinen
(GR)	Κίτρινο	Μπλε	Λευκό	Πράσινο	Καφέ	Κόκκινο (1,00mm <sup>2</sup> )	Μαύρο	Μαύρο/ Κόκκινο	Καφέ/ Λευκό	Κόκκινο (2,50mm <sup>2</sup> )	Λευκό	Κόκκινο/ Μπλε	Λευκό
(NO)	Gul	Blå	Hvit	Grønn	Brun	Rød (1,00mm <sup>2</sup> )	Svart	Svart/ Rød	Brun/ Hvit	Rød (2,50mm <sup>2</sup> )	Hvit	Rød/ Blå	Hvit
(PL)	Żółty	Niebieski	Biały	Zielony	Brazowy	Czerwony (1,00mm <sup>2</sup> )	Czarny	Czarny/ Czerwony	Brazowy/ Biały	Czerwony (2,50mm <sup>2</sup> )	Biały	Czerwony/ Niebieski	Biały