



Montage-handleiding elektrokabelset voor
trekhaak met 12-N contactdoos
vlg. DIN/ISO norm 1724

Fitting instructions electric wiringkit
towbar with 12-N socket up to
DIN/ISO norm 1724

Einbauanleitung Elektrosatz
Anhängervorrichtung mit 12-N Steckdose
lt. DIN/ISO Norm 1724

Instructions de montage du faisceau
électrique pour crochet d'attelage
conforme à la norme DIN/ISO 1724
prise 12-N

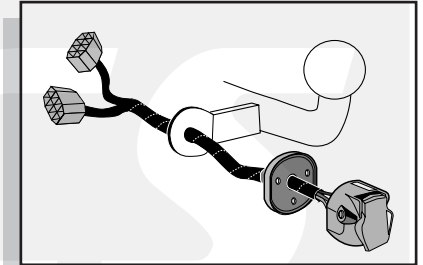

Hyundai Lantra Wagon 1995-
1999-

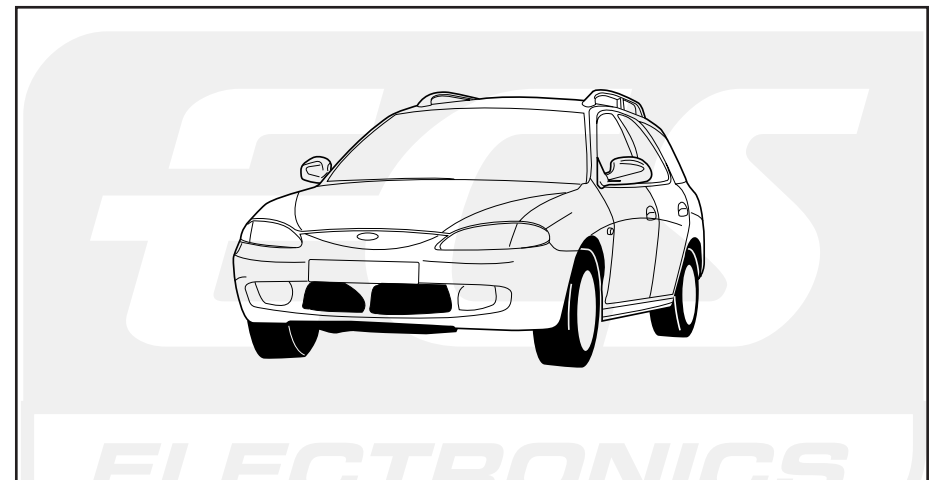

Bestel Nr.: HYU-032-B

* Teilliste

* Liste de pieces

* Part list

* Onderdelenlijst

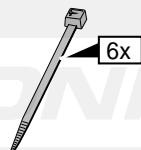
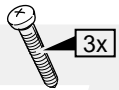
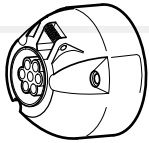
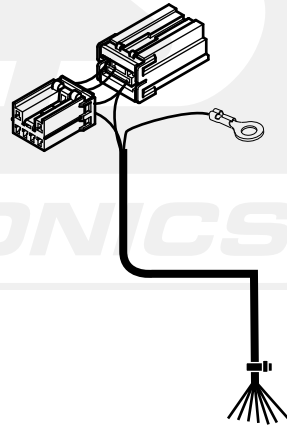
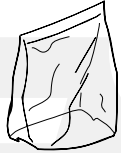
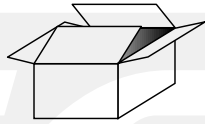

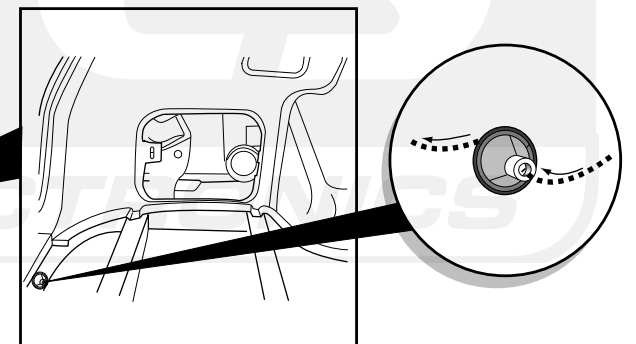
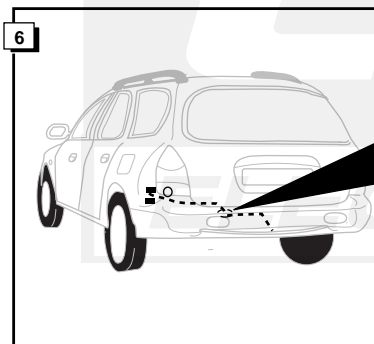
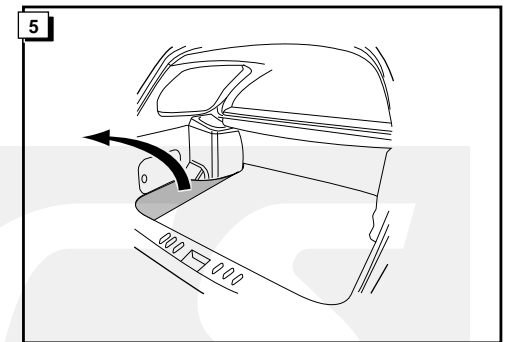
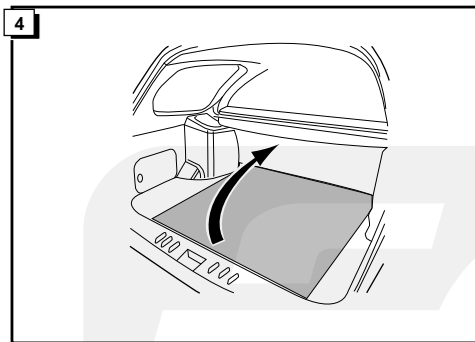
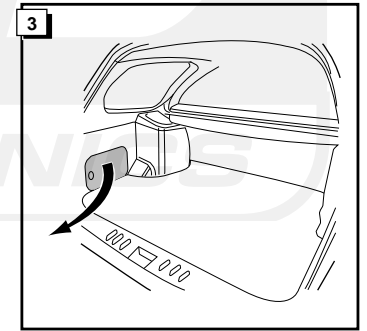
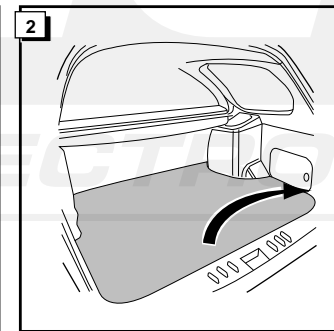
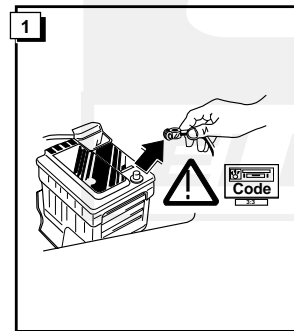
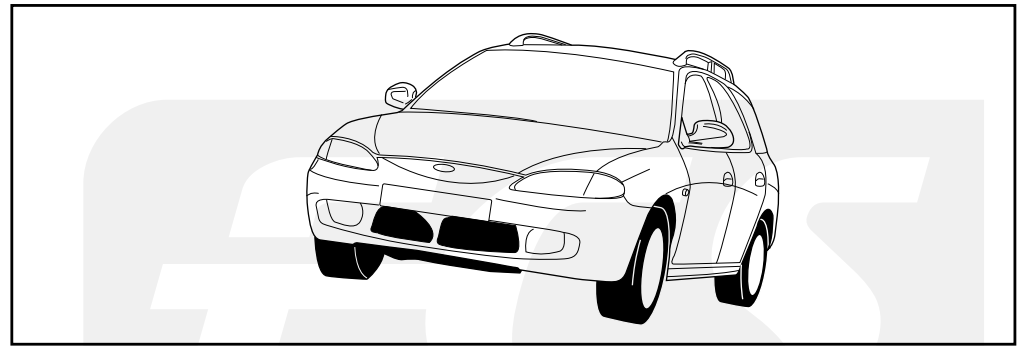

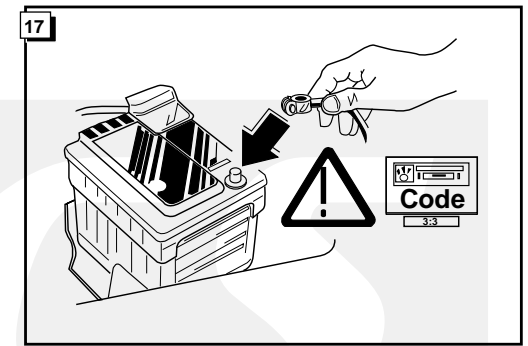
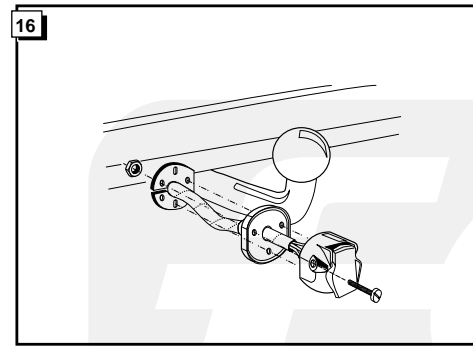
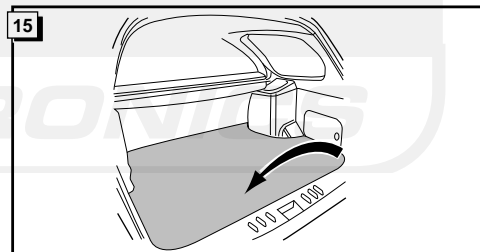
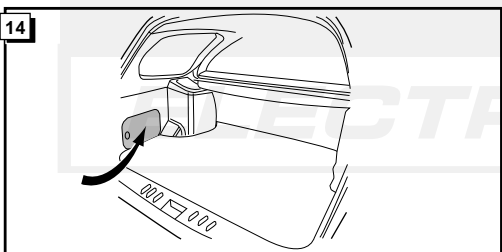
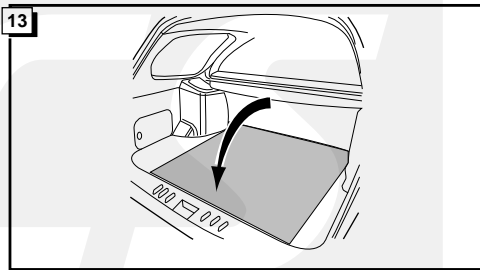
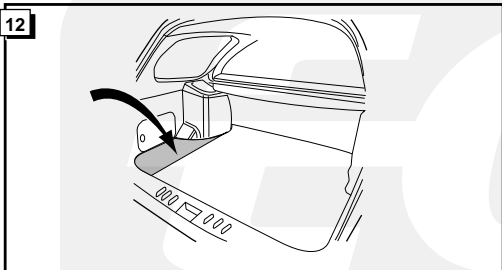
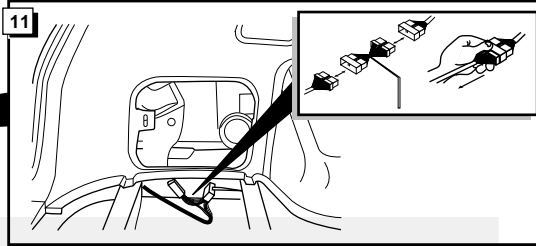
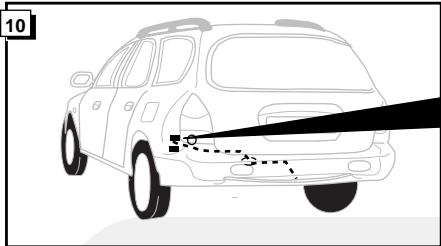
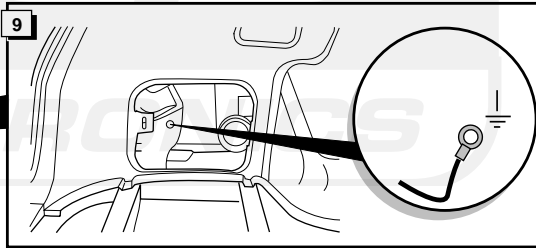
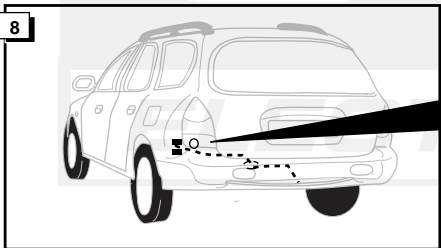
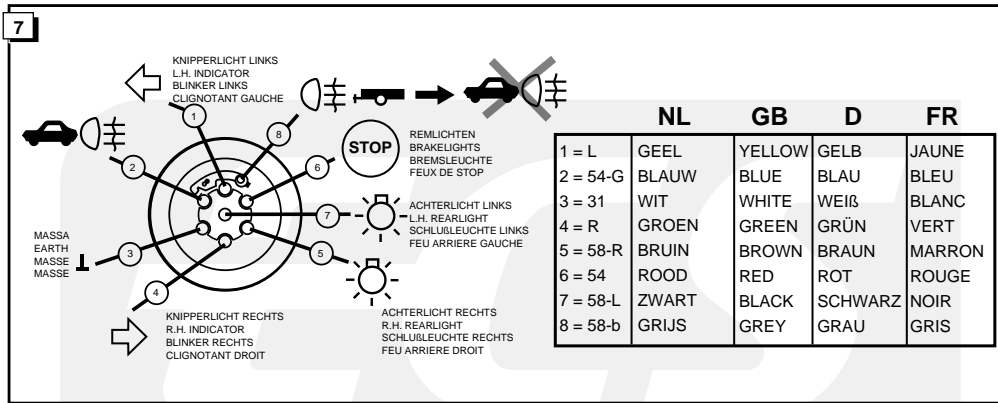

18

CONTROLEER FUNCTIES !
CHECK FUNCTIONS !
FUNKTIONEN KONTROLLIEREN !
CONTRÔLER LES FONCTIONS !