

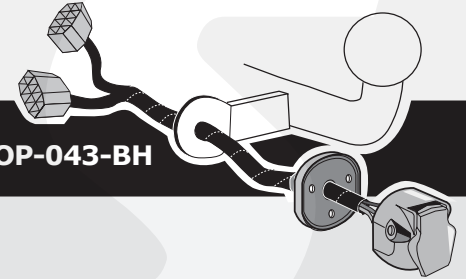

## Opel Astra H GTC 12/2004-

Partnr.: OP-043-BH



**DE** Einbauanleitung Elektrosatz Anhänger-Vorrichtung mit 12-N Steckdose lt. DIN/ISO Norm 1724.

**FR** Instructions de montage du faisceau électrique pour crochet d'attelage conforme à la norme DIN/ISO 1724 prise 12-N

**NL** Montage-handleiding elektrokabelset voor trekhaak met 12-N contactdoos vlg. DIN/ISO norm 1724.

**GB** Fitting instructions electric wiring kit tow bar with 12-N socket up to DIN/ISO Norm 1724.

**ES** Instrucciones de montaje de kit eléctrico para engancho de remolque con caja de conexiones 12-N según norma DIN/ISO 1724.

**IT** Istruzioni di montaggio di set di cavi elettrici per gancio da traino con zoccolo a 12 N conforme alla norma DIN/ISO 1724.

**SE** Monteringsanvisningar elkabelsats för dragkrok med 12-N kontaktdosa enligt DIN/ISO norm 1724.

**CZ** Montážní pokyny: souprava pro elektrické propojení tažné tyče s 12 - N zásuvkou do normy DIN/ISO 1724.

**DK** Monteringsvejledninger for det elektriske ledningsføringssæt for trækstang med 12-N stikdåse, DIN/ISO, norm 1724.

**FI** Ohjeet vetokoukun sähkökaapelisarjan asentamiseen, jossa on DIN/ISO 1724 mukainen 12-N liitin.

**GR** Οδηγίες συναρμολόγησης ηλεκτρικού σετ καλωδίων μπάρας ρυμούλκησης με υποδοχή 12-N μέχρι DIN/ISO Κανόνας 1724.

**NO** Monteringsanviser elkabelsett for trekrok med 12-N koblingsboks ifølge DIN/ISO norm 1724.

**PL** Instrukcje montażu zestawu okablowania elektrycznego dyszla holowniczego z 12-N stykowym gniazdem DIN/ISO 1724.

**DE** - Wir weisen ausdrücklich darauf hin, dass eine unsachgemäße und nicht in einer Fachwerkstatt durchgeführte Montage einen Verzicht auf Entschädigung jeglicher Art insbesondere bezüglich des Produkthaftpflichtrechts zur Folge hat

**FR** - Il est expressément prévu qu' on ne saurait se prévaloir d'un quelconque préjudice contractuel ou réhibitoire si le montage avait été fait en dépit des dites instructions ou dans un garage ne disposant pas des équipements adéquats.

**NL** - Wij wijzen er met nadruk op, dat ondeskundige en niet door een vakkundige werkplaats uitgevoerde montage tot gevolg heeft dat daardoor ieder recht op schadevergoeding, ook op wettelijke aansprakelijkheid inzake producten, vervalt.

**GB** - We would expressly point out that assembly not carried out properly by a competent installer will result in cancellation of any right to damage compensation, in particular those arising by virtue of the product liability act.

**ES** - El montaje inapropiado y efectuado por personal no cualificado originará la pérdida de todo derecho a indemnización o la expiración de toda responsabilidad civil con respecto al producto.

**IT** - Sottolineiamo espressamente che un montaggio inadeguato ed eseguito da un'officina non specializzata ha come conseguenza il decadere di qualsiasi diritto al risarcimento danni, nonché alla responsabilità legale relativa ai prodotti.

**SE** - Vi påpekar med eftertryck att all rätt till skadeersättning och all laglig ansvarighet förfaller om monteringen inte har utförts på rätt sätt och av en professionell verkstad.

**CZ** - Výslovně zdůrazňujeme, že jakákoli montáž, která není provedená ve specializované dílně, má za následek odvolání nároků na kompenzaci jakéhokoliv druhu, obzvláště vyplývajících ze zákona o odpovědnosti za způsobené škody.

**DK** - Vi ønsker at gøre udtrykkeligt opmærksom på at forkert samling, der ikke er udført af et specialiseret værksted, resulterer i bortfaldelse af kompenseringskrav af alle slags, i særdeles krav der måtte opstå omkring det lovpligtige ansvar.

**FI** - Korostamme, että kaikki oikeudet vahinkokorvaukseen kuten myös valmistajan laillinen vastuu raukeavat, mikäli asennusta ei ole toteutettu oikealla tavalla eikä ammattitaitoisen asiantuntijan toimesta.

**GR** - Επισημαίνουμε κατηγορηματικά ότι οποιαδήποτε εσφαλμένη συναρμολόγηση, η οποία δεν έχει πραγματοποιηθεί ειδικό εργαστήριο θα οδηγήσει σε απονομή των αξιώσεων επιβολής αποζημιώσεων οποιαδήποτε είδους, ειδικά όσα προκύπτουν από το νόμο ευθύνης προϊόντων.

**NO** - Vi påpeker ettertrykkelig at all rett til skadeerstatning og rettslig ansvar forfaller dersom monteringen ikke er blitt utført på riktig måte og av et profesjonelt verksted.

**PL** - Chcielibyśmy wyraźnie zaznaczyć, iż wszelki nieprawidłowy montaż, który nie jest wykonywany w specjalistycznym warsztacie pociąga za sobą utratę możliwości dochodzenia wszelkiego typu roszczeń, w szczególności tych wynikających z odpowiedzialności producenta za swój produkt.

- Technische Änderungen vorbehalten.  
- Widerstand nur gemäß der Tabelle auf dem Anhänger verwenden, siehe Seite 11.

- Sous réserve de modifications techniques.  
- Ne excédez pas la charge maximale, indiquée dans le tableau sur page 11.

- Technische wijzigingen voorbehouden.  
- Gebruik alleen belasting volgens aansluittabel op het getrokken voertuig, zie pagina 11.

- Contents of these kits and their fitting manuals are subject to alteration without notice, please ensure that these instructions are read and fully understood before commencing installation.

- Do not overload circuits; the maximum loads per connection are detailed in this manual.  
- Nos reservamos el derecho a efectuar modificaciones técnicas.  
- Utilice sólo cargas de acuerdo a la tabla de conexión del vehículo remolcado (ver página 11).

- Ci si riserva il diritto di apportare modifiche tecniche.  
- Utilizzare esclusivamente un carico conforme alla tabella degli allacci relativa al veicolo in questione, cfr. pagina 11.

- Tekniska ändringar förbehålles.  
- Använd endast belastning enligt anslutningstabellen på det dragna fordonet, se sid. 11.

- Změny mohou být provedeny bez oznámení.  
- Používejte pouze při maximálním nabití podle tabulky na tažném vozidle, viz. str. 11.

- Kan ændres uden varsel.  
- Brug kun den maksimale belastning, i overensstemmelse med forbindelsestabelen for bugserede køretøjer, side 11.

- Oikeus teknisiin muutoksiin ilman erillistä huomautusta pidetään.  
- Kuormita työvirtapiiriä ainoastaan hinattavan ajoneuvon kytkentäkaavion mukaisesti, katso sivu 11.

- Μπορεί να τροποποιηθεί χωρίς προηγούμενη ειδοποίηση.  
- Χρησιμοποιείτε μόνο μέγιστο ηλεκτρικό φορτίο σύμφωνα με τον πίνακα σύνδεσης στο ρυμούλκούμενο όχημα, δείτε σελίδα 11.

- Tekniske endringer forbeholdes. - Overskrid ikke grensene anviset i tilkoblingstabellen på tilhengeren eller det tilkoblede kjøretøyet, se s. 11.

- Podlega zmianom bez powiadomienia.  
- Używać tylko takiego maksymalnego obciążenia które wynika z tabliczki połączeń holowanego pojazdu, patrz strona 11.

Einzelteilliste

Liste de pièces

Onderdelenlijst

Part list

Lista de componentes

Elenco componenti

Dellista

Seznam dílů

Del-liste

Osaluettelo

Κατάλογος εξαρτημάτων

Delliste

Lista części

DE

FR

NL

GB

ES

IT

SE

CZ

DK

FI

GR

NO

PL

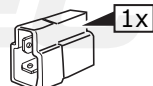
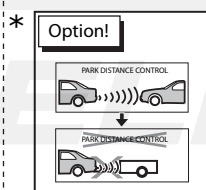
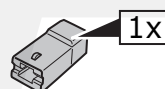
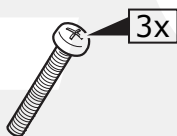
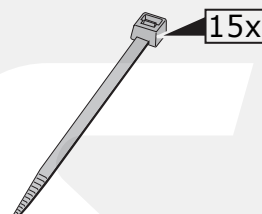
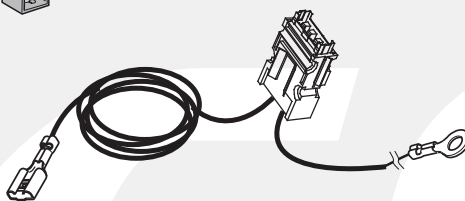
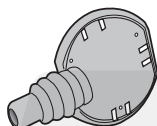
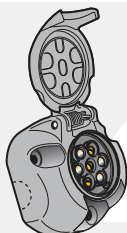
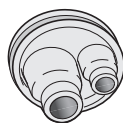
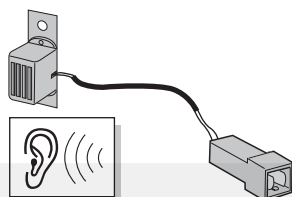
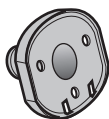
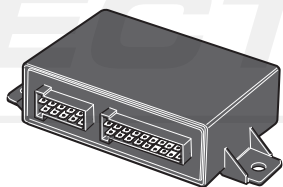
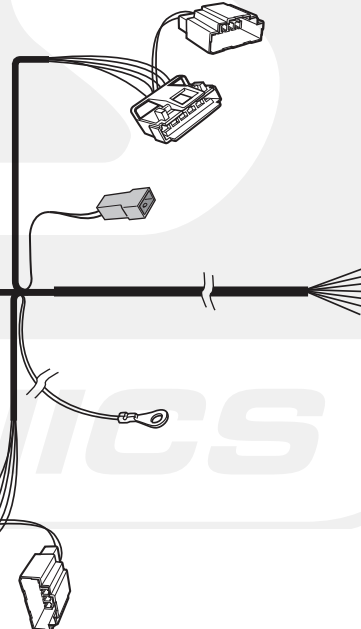
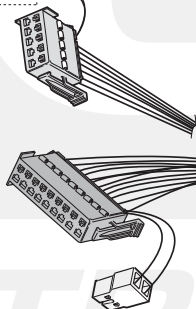
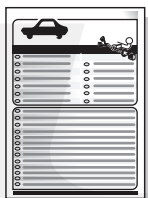
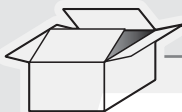

1

- Ⓛ DE Gebrauchsanleitung.
- Ⓛ FR Mode d'emploi.
- Ⓛ NL Gebruikershandleiding.
- Ⓛ GB User guide.
- Ⓛ ES Guía del usuario.
- Ⓛ IT Manuale di istruzioni.
- Ⓛ SE Bruksanvisning.
- Ⓛ CZ Uživatelská příručka.
- Ⓛ DK Brugervejledning.
- Ⓛ FI Käyttöohjeet.
- Ⓛ GR Οδηγός χρήστη.
- Ⓛ NO Brukerveiledning.
- Ⓛ PL Instrukcja obsługi.

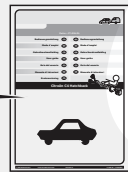
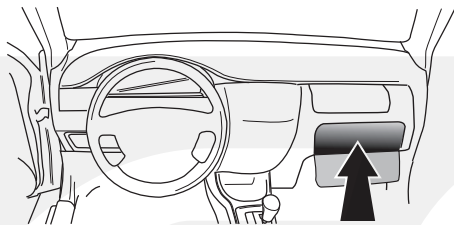

2

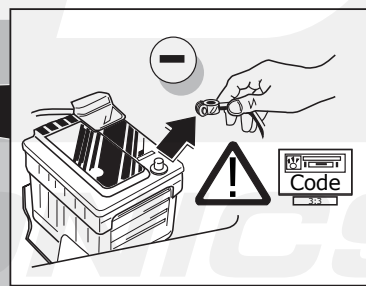
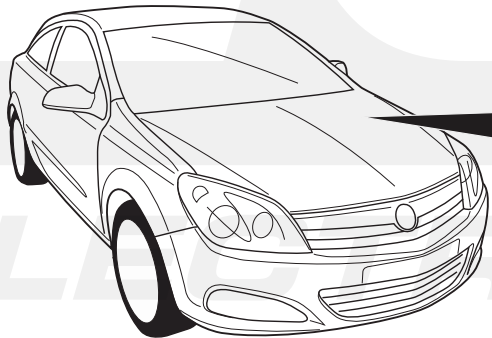

3

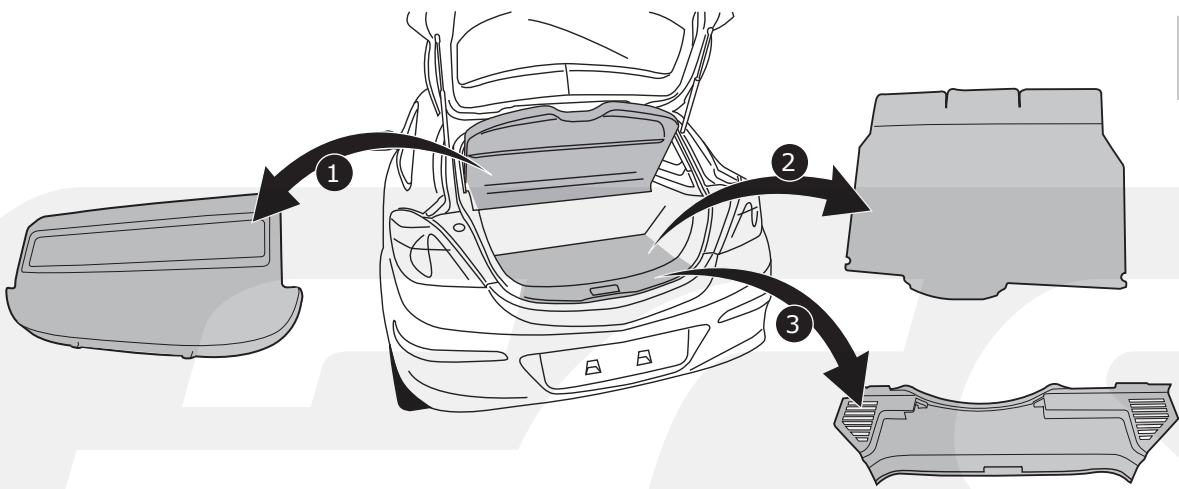

4

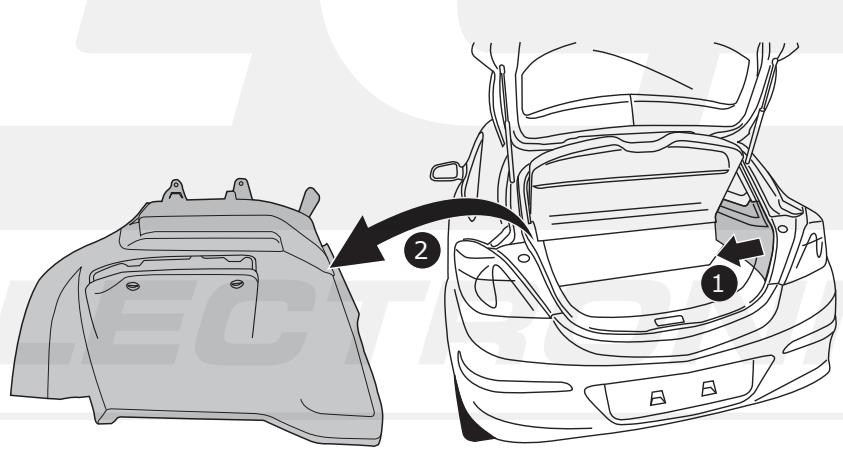

**INFO**

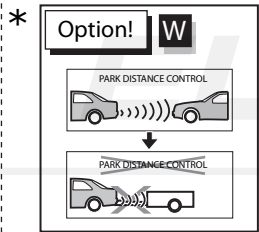
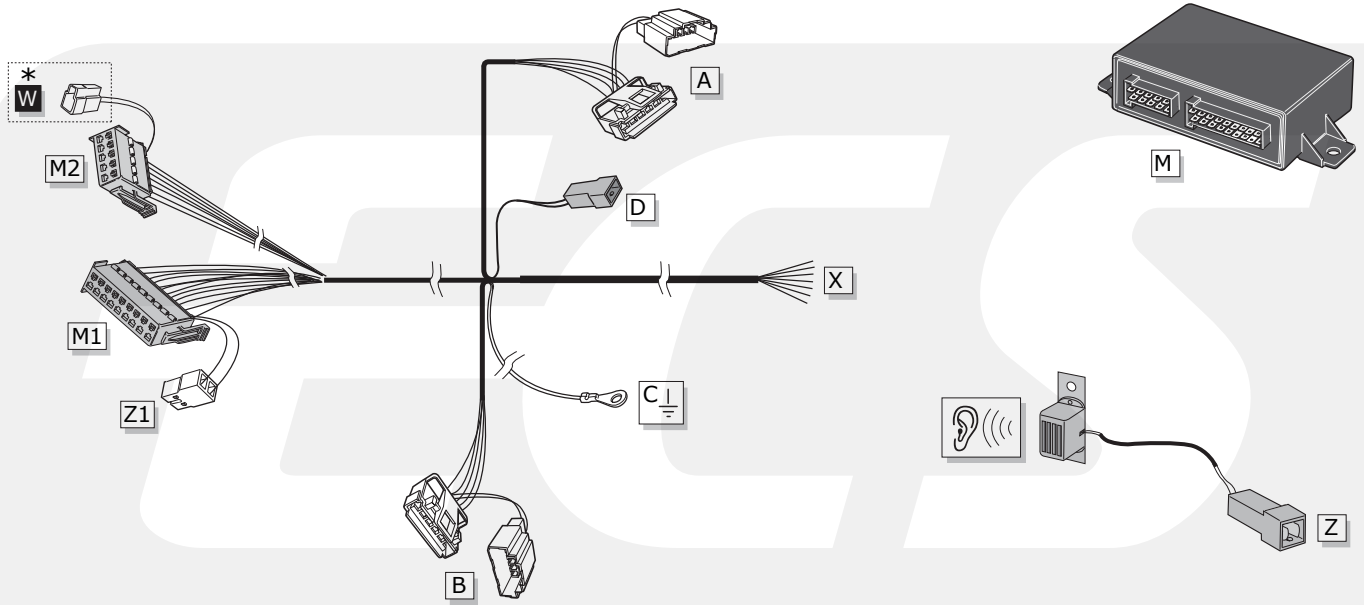

**ROUTING**

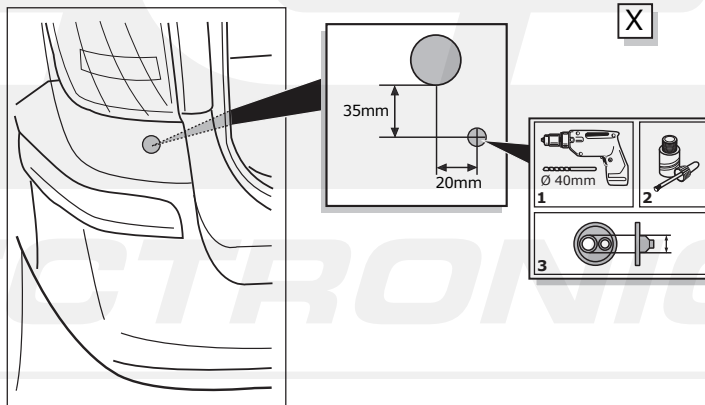
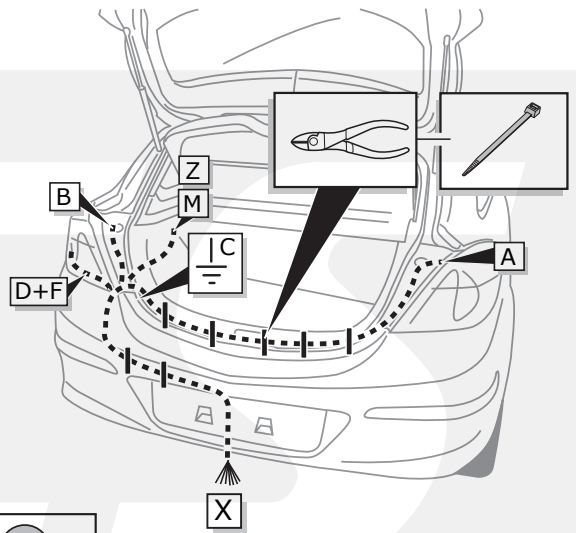
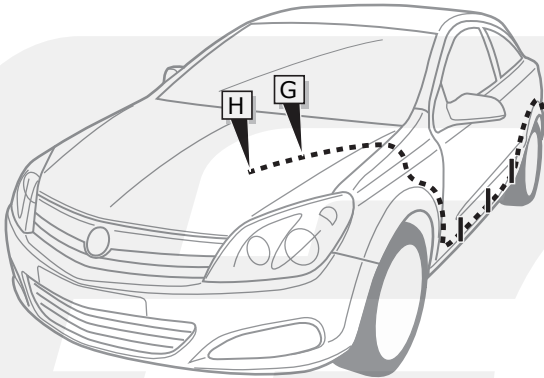

**A**

Option 1

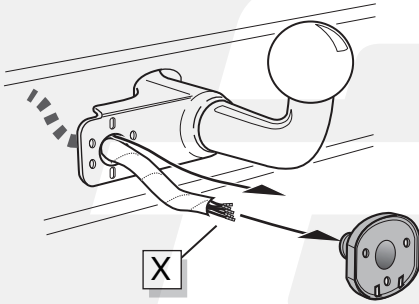

Option 2

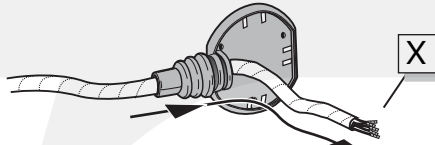

Option 3

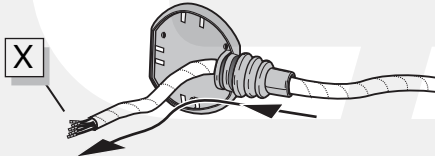
**INFO**

- Ⓧ Anschluss Steckdose
- Ⓧ Connection de la prise
- Ⓧ Contactdoos aansluiting
- Ⓧ Socket connection
- Ⓧ Conexión de la caja de enchufe
- Ⓧ Allaccio zoccolo
- Ⓧ Anslutning kontaktdosa
- Ⓧ Objímkový konektor
- Ⓧ Stikdåse forbindelse
- Ⓧ Pistorasia liitäntä
- Ⓧ Υποδοχή σύνδεσης
- Ⓧ Tilkobling koblingsboks
- Ⓧ Połączenie przez gniazdo



Pag. 11

**B**

Option 1

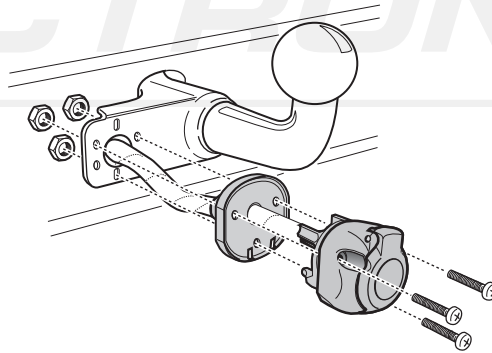
**C**

Option 2

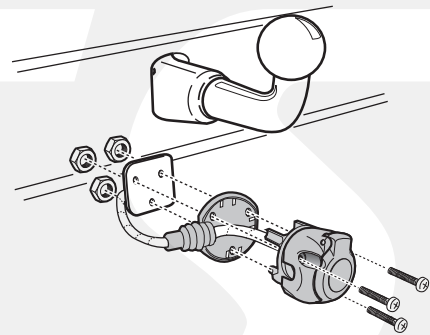
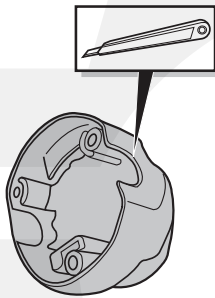
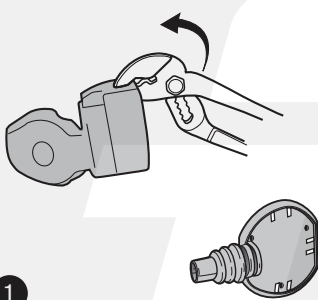
**D**

Option 3

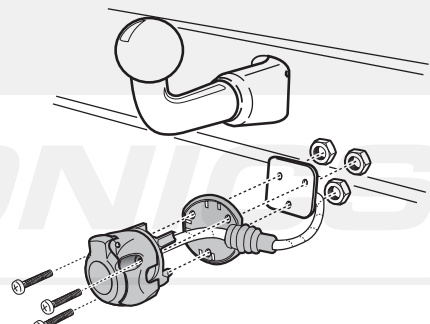
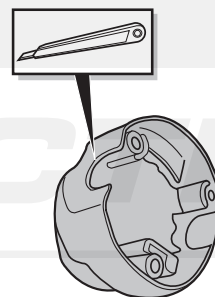
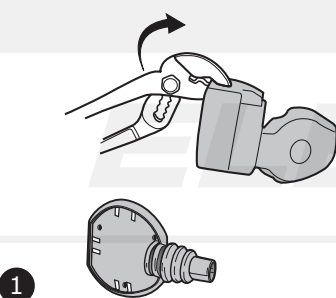

5

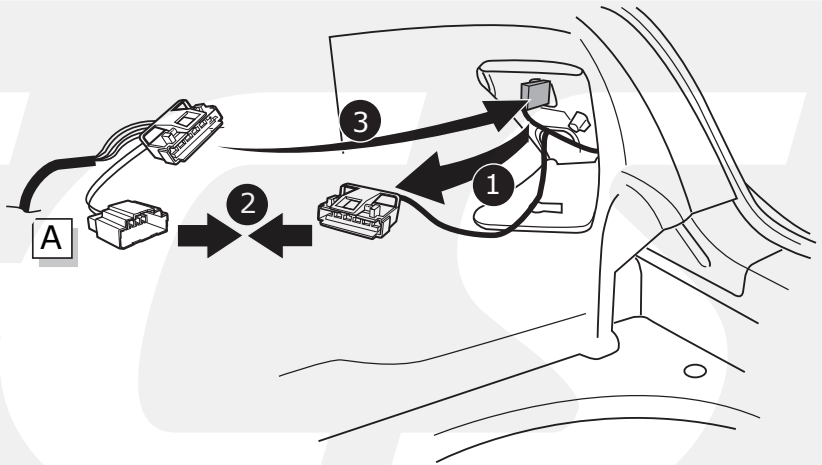
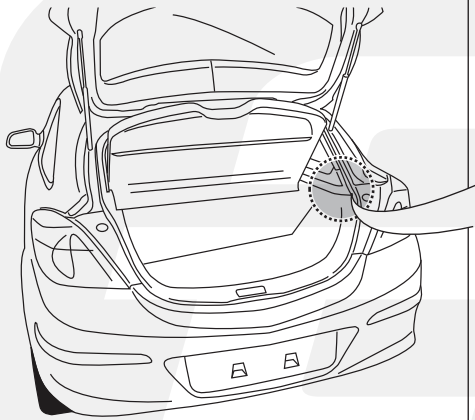

6

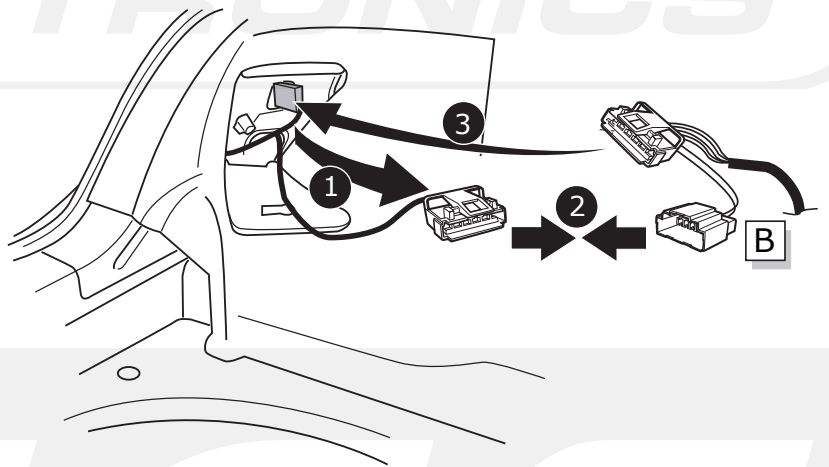
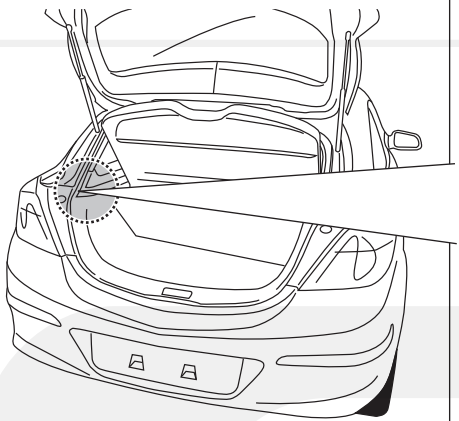

7

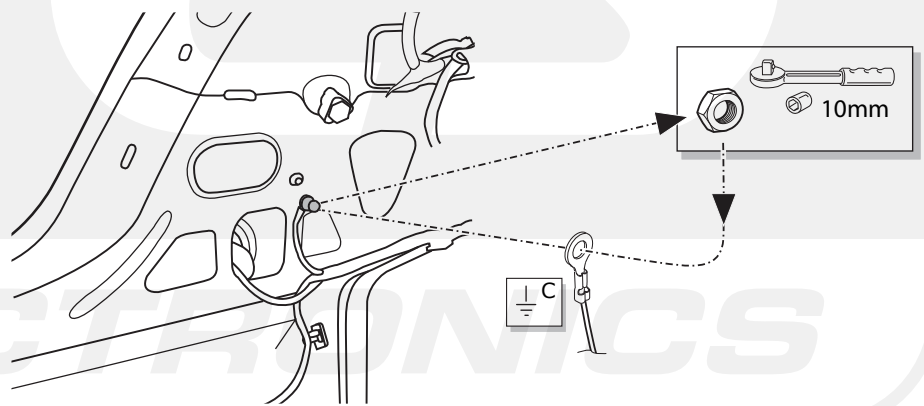
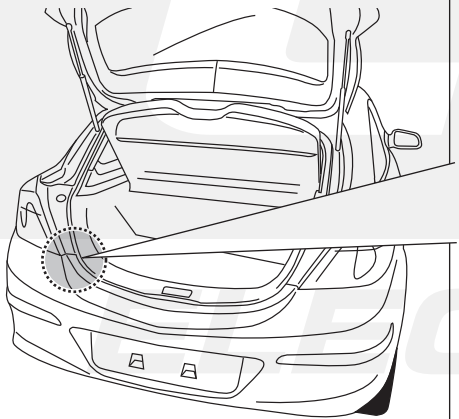

8

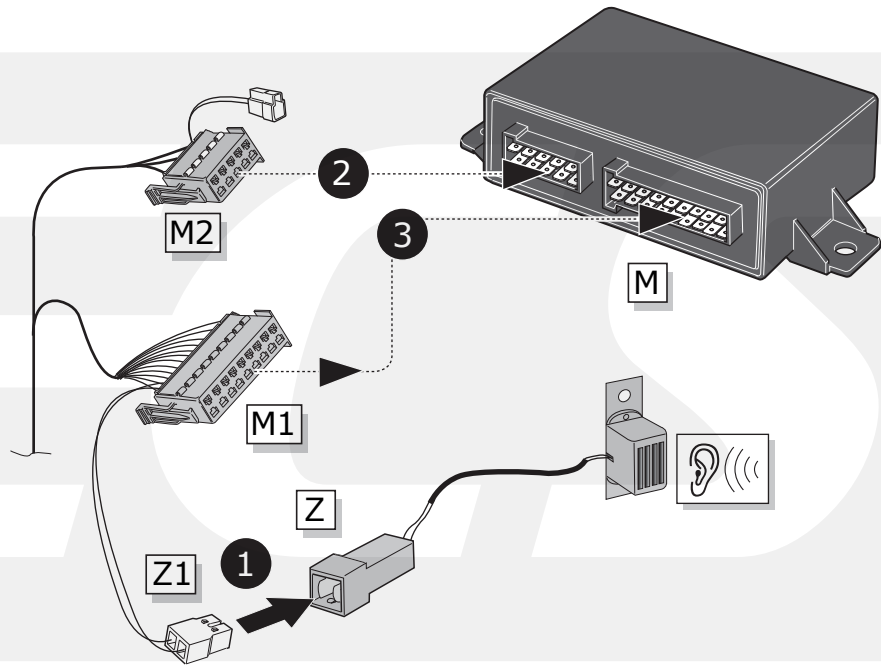
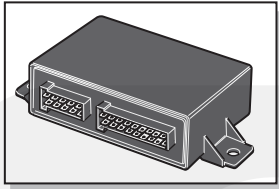

9

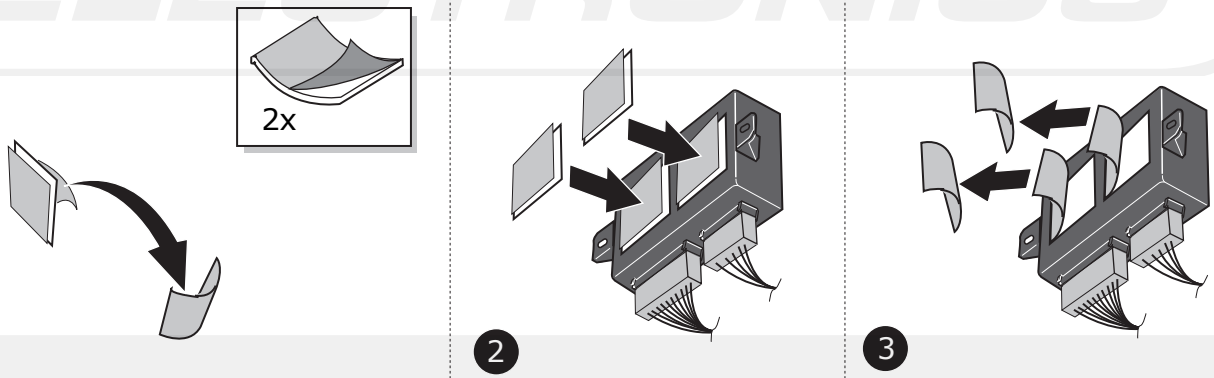

10

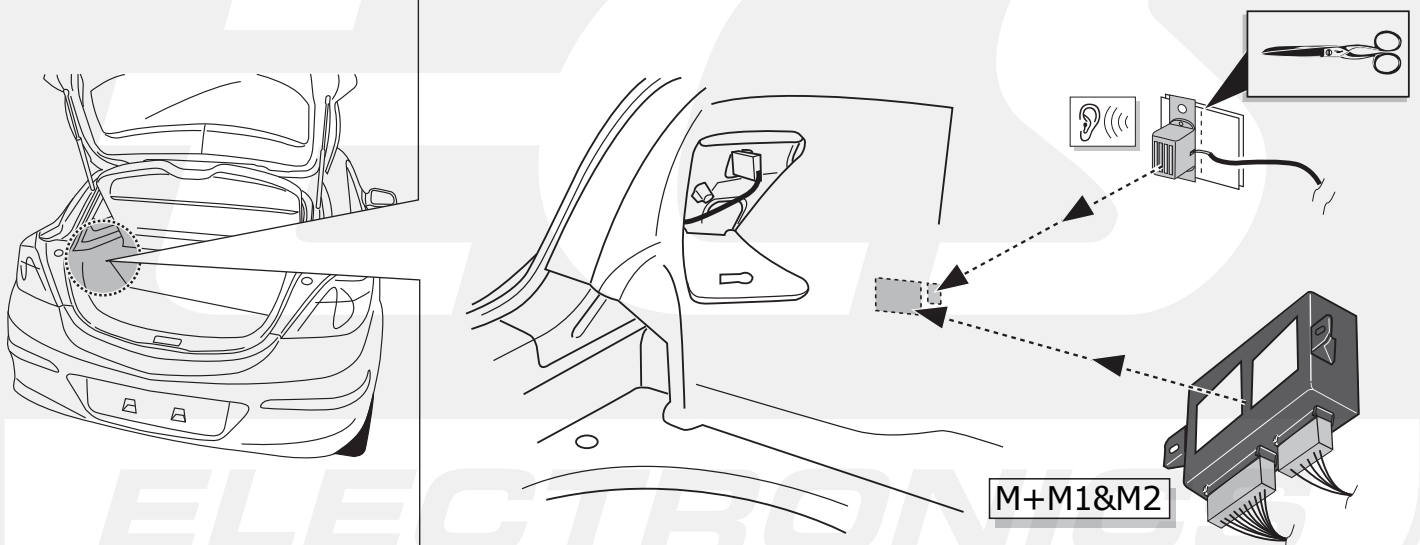

11

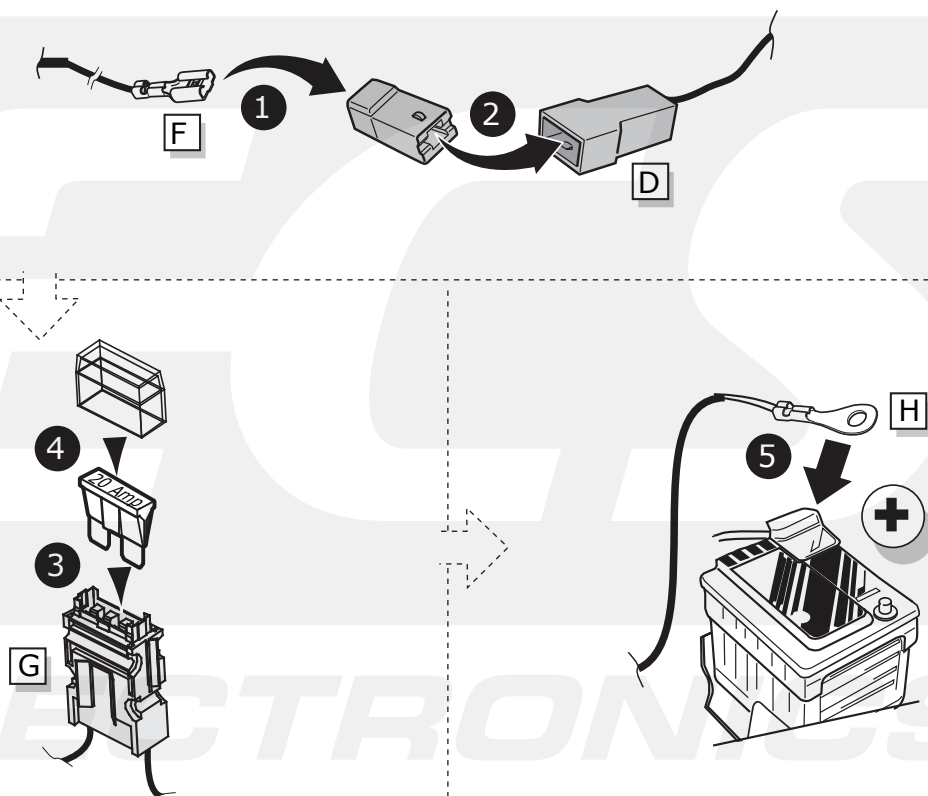

12

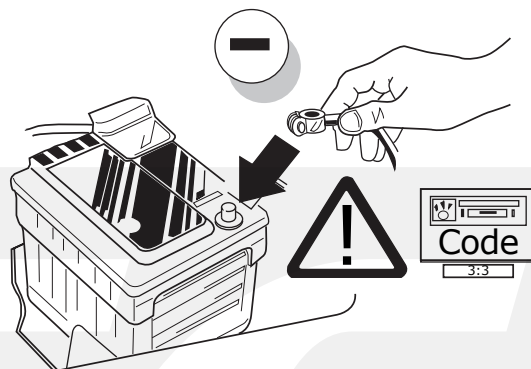

13

- DE** FUNKTIONEN KONTROLLIEREN MIT EINEM PRÜFGERÄT MIT WIDERSTAND ODER MIT LEUCHTEN MIT DER GENAUEN WATTZAHL!
- FR** CONTRÔLER LES FONCTIONS AVEC UNE BOÎTE DE TEST AVEC DE LA CHARGE OU DES LAMPES AVEC LA QUANTITÉ CORRECTE DE WATT!
- NL** CONTROLEER FUNCTIES MET EEN TESTER MET BELASTING OF LAMPEN MET DE JUISTE WATTAGE!
- GB** TEST ALL CIRCUIT FUNCTIONS WITH A TESTBOX WITH THE CORRECT POWER LOAD FOR EACH UNIT. A TESTBOX ON WHICH ONLY LEDs ARE USED CAN NOT BE USED IN THIS CASE
- ES** ¡CONTROLAR FUNCIONES CON UN TESTER CON CARGA O LUCES CON EL CORRECTO WATTAJE!
- IT** CONTROLLA FUNZIONI CON UN TESTER CON CARICO O LAMPADIE DEL GIUSTO WATT-TAGGIO!
- SE** KONTROLLERA FUNKTIONERNA MED EN TESTARE MED BELASTNING ELLER LAMPOR MED RÄTT WATT-VÄRDE!
- CZ** OVĚŘTE FUNKCE POMOČÍ TESTOVACÍHO BOXU NEBO SVĚTEL S PŘÍSLUŠNÝM VÝKONEM!
- DK** CHECK FUNKTIONERNE MED EN TESTBOKS, MED BELASTNING ELLER MED LYGTER MED DET KORREKTE ANTAL WATT!
- FI** TARKISTA TOIMINNOT KÄYTTÄMÄLLÄ TESTILAITE, JOSSA ON OIKEATEHOINEN KUORMITUS TAI OIKEATEHOISET LAMPUT!
- GR** ΕΛΕΓΕΤΕ ΤΙΣ ΛΕΙΤΟΥΡΓΙΕΣ ΜΕ ΉΝΑ ΚΙΒΩΤΙΟ ΔΟΚΙΜΗΣ ΜΕ ΦΟΡΤΙΟ Ή ΛΑΜΠΗΡΕΣ ΣΩΣΤΗΣ ΠΟΣΟΤΗΤΑΣ ΒΑΤ!
- NO** KONTROLER FUNKSJONENE MED EN TESTER MED BELASTNING ELLER LYSFERER MED RIKTIG WATTVERDI!
- PL** SPRAWDŹ FUNKCJE UŻYWAJĄC SKRZYŃKI TESTOWEJ Z OBCIĄŻENIEM LUB PODŁĄCZONYMI ŻARÓWKAMI O ODPOWIEDNIEJ MOCY!



14

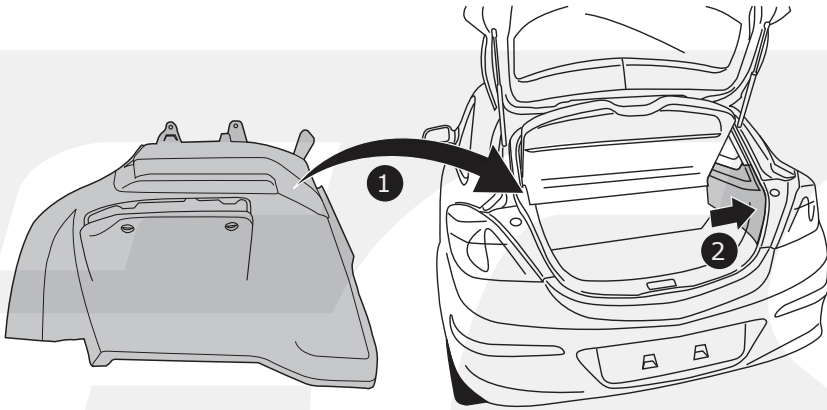
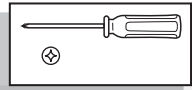

15

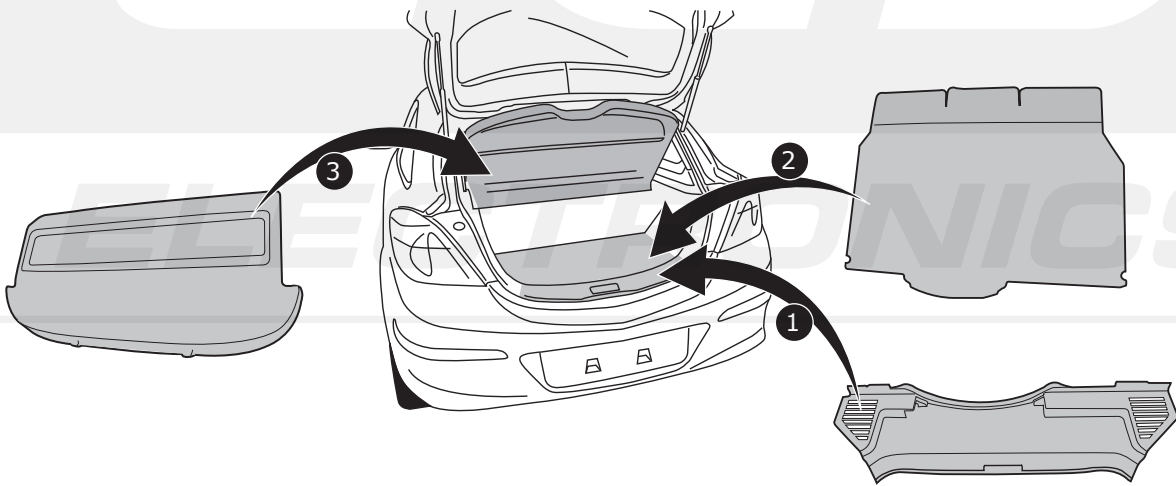
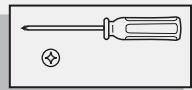





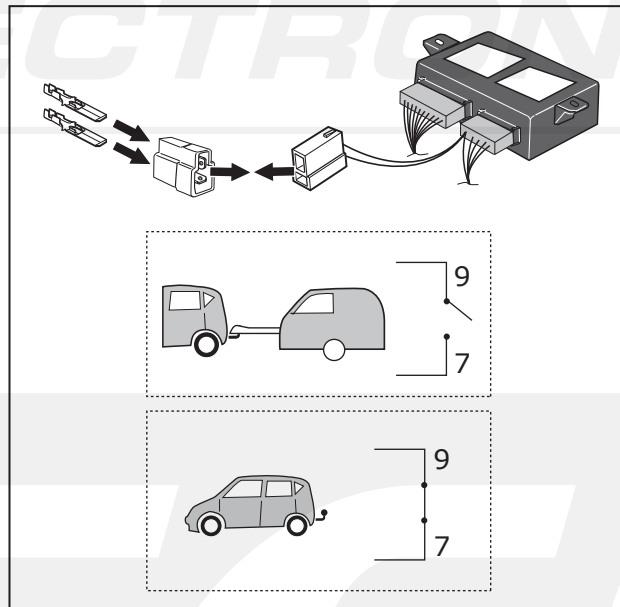
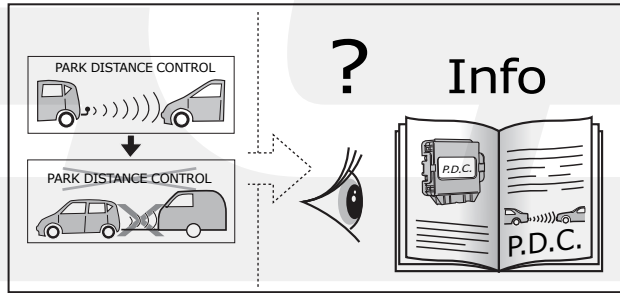
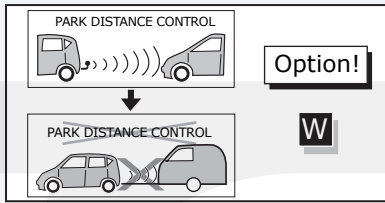

ECS

ELECTRONICS

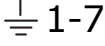

ELECTRONICS

- (DE) Anschluss Steckdose
- (FR) Connection de la prise
- (NL) Contactdoos aansluiting
- (GB) Socket connection
- (ES) Conexión de la caja de enchufe
- (IT) Allaccio zoccolo
- (SE) Anslutning kontaktdosa
- (CZ) Objímkový konektor
- (DK) Stikdåse forbindelse
- (FI) Pistorasia liitäntä
- (GR) Υποδοχή σύνδεσης
- (NO) Tilkobling koblingsboks
- (PL) Połączenie przez gniazdo

| DIN/ISO<br>1724 |  |  |  |  |  |  |  |
|-----------------|---|---|---|---|---|---|---|
|                 | 1/L   | 2   | 3/31  | 4/R   | 5/58-R  | 6/54  | 7/58-L  |
| Pmax            | 21W   | 21W   |   | 21W   | 52W   | 3x21W   | 52W   |
| (DE)            | Gelb  | Blau  | Weiß  | Grün  | Braun   | Rot   | Schwarz   |
| (FR)            | Jaune   | Bleu  | Blanc   | Vert  | Marron  | Rouge   | Noir  |
| (NL)            | Geel  | Blaauw  | Wit   | Groen   | Bruin   | Rood  | Zwart   |
| (GB)            | Yellow  | Blue  | White   | Green   | Brown   | Red   | Black   |
| (ES)            | Amarillo  | Azul  | Blanco  | Verde   | Marrón  | Rojo  | Negro   |
| (IT)            | Giallo  | Blu   | Bianco  | Verde   | Marrone   | Rosso   | Nero  |
| (SE)            | Gul   | Blå   | Vit   | Grön  | Brun  | Röd   | Svart   |
| (CZ)            | Žlutá   | Modrá   | Bílá  | Zelená  | Hnědá   | Červená   | Černá   |
| (DK)            | Gul   | Blå   | Hvid  | Grøn  | Brun  | Rød   | Sort  |
| (FI)            | Keltainen   | Sininen   | Valkoinen   | Vihreä  | Ruskea  | Punainen  | Musta   |
| (GR)            | Κίτρινο   | Μπλε  | Λευκό   | Πράσινο   | Καφέ  | Κόκκινο   | Μαύρο   |
| (NO)            | Gul   | Blå   | Hvit  | Grønn   | Brun  | Rød   | Svart   |
| (PL)            | Żółty   | Niebieski   | Biały   | Zielony   | Brązowy   | Czerwony  | Czarny  |