

**Ford C-MAX II 07/2010-
Ford Focus Sedan 01/2011-
Ford Focus Hatchback 01/2011-**

Partnr.: FR-050-ZZ

(DE) Ergänzungssatz

(FR) Set d'extension

(NL) Uitbreidingsset

(GB) Extension kit

(ES) Equipo de extensión

(IT) Set di ampliamento

(SE) Förlängningsatts

(CZ) Prodlužovací souprava

(DK) Forlængelsesæt

(FI) Lisäsarja

(GR) εξάρτηση επέκτασης

(NO) Påbyggingssett

(PL) Zestaw rozszerzający

(DE) - Wir weisen ausdrücklich darauf hin, dass eine unsachgemäße und nicht in einer Fachwerkstatt durchgeführte Montage einen Verzicht auf Entschädigung jeglicher Art insbesondere bezüglich des Produkthaftpflichtrechts zur Folge hat

(FR) - Il est expressément prévu qu' on ne saurait se prévaloir d'un quelconque préjudice contractuel ou rédhibitoire si le montage avait été fait en dépit des dites instructions ou dans un garage ne disposant pas des équipements adéquats.

(NL) - Wij wijzen er met nadruk op, dat ondeskundige en niet door een vakkundige werkplaats uitgevoerde montage tot gevolg heeft dat daardoor ieder recht op schadevergoeding, ook op wettelijke aansprakelijkheid inzake producten, vervalt.

(GB) - We would expressly point out that assembly not carried out properly by a competent installer will result in cancellation of any right to damage compensation, in particular those arising by virtue of the product liability act.

(ES) - El montaje inapropiado y efectuado por personal no cualificado originará la pérdida de todo derecho a indemnización o la expiración de toda responsabilidad civil con respecto al producto.

(IT) - Sottolineiamo espressamente che un montaggio inadeguato ed eseguito da un'officina non specializzata ha come conseguenza il decadere di qualsiasi diritto al risarcimento danni, nonché alla responsabilità legale relativa ai prodotti.

(SE) - Vi påpekar med eftertryck att all rätt till skadeersättning och all laglig ansvarighet förfaller om monteringen inte har utförts på rätt sätt och av en professionell verkstad.

(CZ) - Výslovně zdůrazňujeme, že jakákoli montáž, která není provedená ve specializované dílně, má za následek odvolání nároků na kompenzaci jakéhokoli druhu, obzvláště vyplývajících ze zákona o odpovědnosti za způsobené škody.

(DK) - Vi ønsker at gøre udtrykkeligt opmærksom på at forkert samling, der ikke er udført af et specialiseret værksted, resulterer i bortfaldelse af kompenseringskrav af alle slags, i særdeles krav der måtte opstå omkring det lovpligtige ansvar.

(FI) - Korostamme, että kaikki oikeudet vahinkokorvaukseen kuten myös valmistajan laillinen vastuu raukeavat, mikäli asennusta ei ole toteutettu oikealla tavalla eikä ammattitaitoisen asiantuntijan toimesta.

(GR) - Επισημαίνουμε κατηγορηματικά ότι οποιαδήποτε εσφαλμένη συναρμολόγηση, η οποία δεν έχει πραγματοποιηθεί ειδικό εργαστήριο θα οδηγήσει σε απονοίηση των αξιώνσεων επιβολής αποζημιώσεων οποιαδήποτε είδους, ειδικά όσα προκύπτουν από το νόμο ευθύνης προϊόντων.

(NO) - Vi påpeker ettertrykkelig at all rett til skadeerstatning og rettslig ansvar forfaller dersom monteringen ikke er blitt utført på riktig måte og av et profesjonelt verksted.

(PL) - Chcielibyśmy wyraźnie zaznaczyć, iż wszelki nieprawidłowy montaż, który nie jest wykonywany w specjalistycznym warsztacie pociąga za sobą utratę możliwości dochodzenia wszelkiego typu roszczeń, w szczególności tych wynikających z odpowiedzialności producenta za swój produkt.

- Technische Änderungen vorbehalten.

- Sous réserve de modifications techniques.

- Technische wijzigingen voorbehouden.

- Contents of these kits and their fitting manuals are subject to alteration without notice, please ensure that these instructions are read and fully understood before commencing installation.

- Nos reservamos el derecho a efectuar modificaciones técnicas.

- Ci si riserva il diritto di apportare modifiche tecniche.

- Tekniska ändringar förbehålles.

- Změny mohou být provedeny bez oznámení.

- Kan ændres uden varsel.

- Oikeus teknisiin muutoksiin ilman erillistä huomautusta pidätetään.

- Μπορεί να τροποποιηθεί χωρίς προηγούμενη ειδοποίηση.

- Tekniske endringer forbeholdes.

- Podlega zmianom bez powiadomienia.

DE

FR

NL

GB

ES

IT

SE

CZ

DK

FI

GR

NO

PL

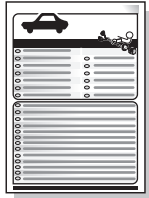
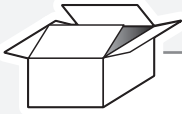

L1



L2



L3

Only for:

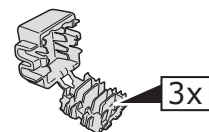
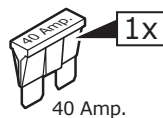
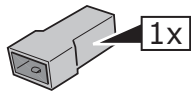
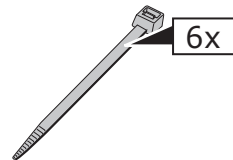
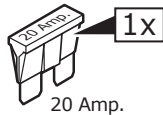
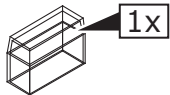
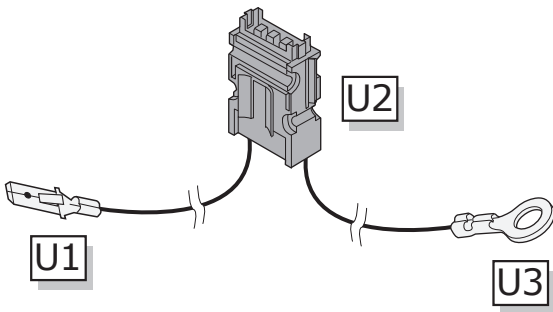
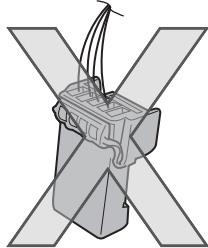

COLOR TABLE

	(DE)	(FR)	(GB)	(NL)	(ES)	(IT)	(SE)	(CZ)	(DK)	(FI)	(GR)	(NO)	(PL)
BU	Blau	Bleu	Blue	Blauw	Azul	Blu	Blå	Modrá	Blå	Sininen	Μπλε	Blå	Niebieska
BK	Schwarz	Noir	Black	Zwart	Negro	Nero	Svart	Černá	Sort	Musta	Μαύο	Sort	Czarna
BN	Braun	Marron	Brown	Bruin	Marrón	Marrone	Brun	Hnědá	Brun	Ruskea	Καφέ	Brun	Brązowa
GN	Grün	Vert	Green	Groen	Verde	Verde	Grön	Zelená	Grøn	Vihreä	Πράσινο	Grønn	Zielona
GY	Grau	Gris	Grey	Grijs	Gris	Grigio	Grå	Šeda	Grå	Harmaa	Γκρι	Grå	Szara
OG	Orange	Orange	Orange	Oranje	Naranja	Arancione	Orange	Oranžová	Orange	Oransi	Πορτοκάλι	Orange	Pomarańczowa
RD	Rot	Rouge	Red	Rood	Rojo	Rosso	Röd	Červená	Rød	Punainen	Κόκκινο	Rød	Czerwona
WH	Weiß	Blanc	White	Wit	Blanco	Bianco	Vit	Bílá	Hvid	Valkoinen	Λευκό	Hvit	Biała
YE	Gelb	Jaune	Yellow	Geel	Amarillo	Giallo	Gul	Žlutá	Gul	Keltainen	Κίτρινο	Gul	Żółta
PK	Rosa	Rose	Pink	Rosé	Rosa	Rosa	Rosa	Růžová	Rosa	Rosa	Ροζ	Rosa	Różowa
PE	Purpur	Pourpre	Purple	Paars	Púrpura	Rosso porpora	Purper	Purpurov	Purper	Purppura	Πορφυρό	Purper	Purpurowa
DL	Dunkelblau	Bleu foncé	Dark blue	Donkerblauw	Azul oscuro	Blu scuro	Mörkblå	Tmavomodrá	Mørkeblå	Tummansininen	Σκούρο μπλε	Mørkeblå	Granatowa
DG	Dunkelgrün	Vert foncé	Dark green	Donkergroen	Verde oscuro	Verde scuro	Mörkgrön	Tmavozelená	Mørkegrøn	Tummanvihreä	Σκούρο πράσινο	Mørkegrønn	Ciemnozielona
LB	Hellblau	Bleu clair	Light blue	Lichtblauw	Azul claro	Blu chiaro	Ljusblå	Bleděmodrá	Lyseblå	Vaaleansininen	Ανοικτό μπλε	Lyseblå	Jasnoniebieska
LG	Hellgrün	Vert clair	Light green	Lichtgroen	Verde claro	Verde chiaro	Ljusgrön	Světlezelená	Lysegrøn	Vaaleanvihreä	Ανοικτό πράσινο	Lysegrønn	Jasnozielona
NL	Naturfarben	Nature	Natural colour	Naturel	Color natural	Colori naturali	Naturfärger	Přírodní	Naturfarvet	Luonnonväri	Φυσικά χρώματα	Naturfarger	Barwy
SB	Himmelblau	Bleu ciel	Sky blue	Hemelsblauw	Azul cielo	Celeste	Himmelsblå	Blankyttná	Himmelblå	Taivaansininen	Γαλάζιο	Himmelblå	Błękitna
T	Gelbbraun	Marron-jaune	Yellow brown	Geelbruin	Amarillo-marrón	Giallomarrone	Gulbrun	Žlutohnědá	Gulbrun	Keltaisenruskea	Κίτρινοκαφέ	Gulbrun	Żółtobrązowa
VT	Violett	Violet	Violet	Violet	Violeta	Viola	Violett	Fialová	Violet	Violetti	Μοβ	Fiolett	Fioletowa

ROUTING

C-Max II: option 1

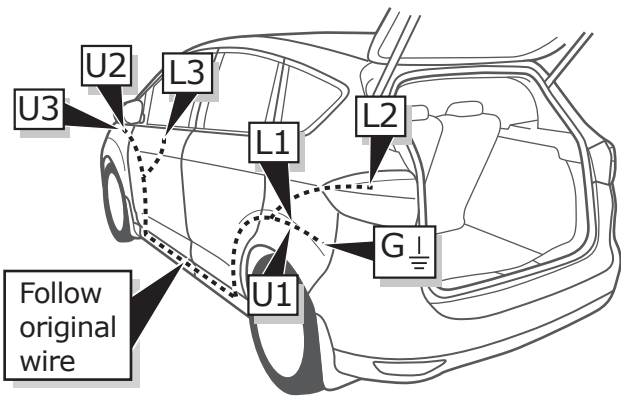

C-Max II: option 2

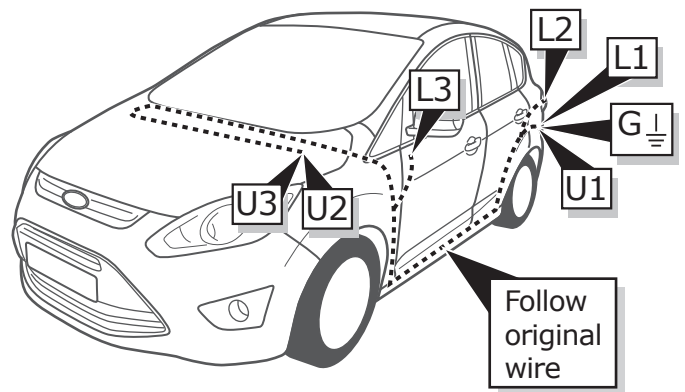

Focus Sedan: option 1

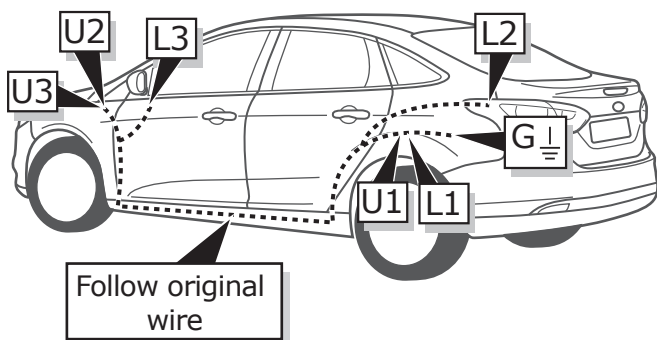

Focus Sedan: option 2

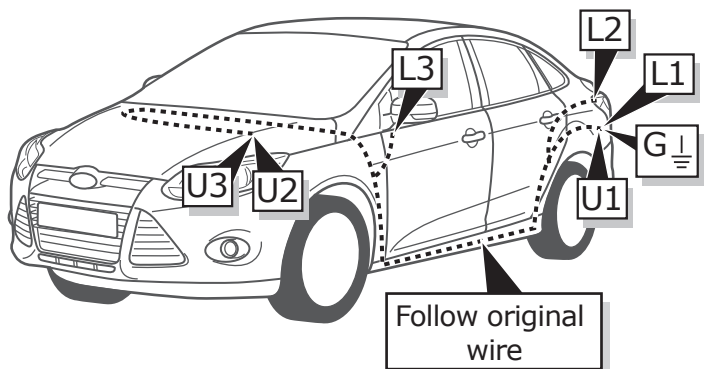

Focus Hatchback: option 1

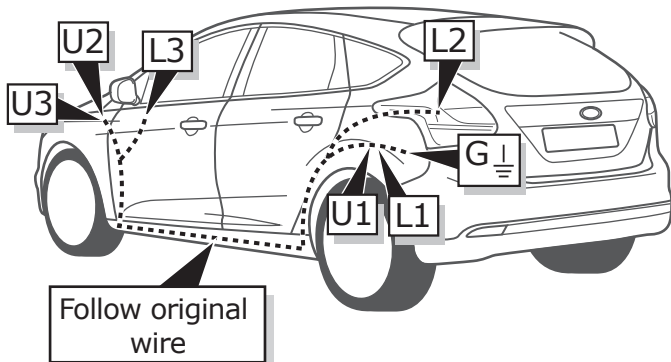

Focus Hatchback: option 2

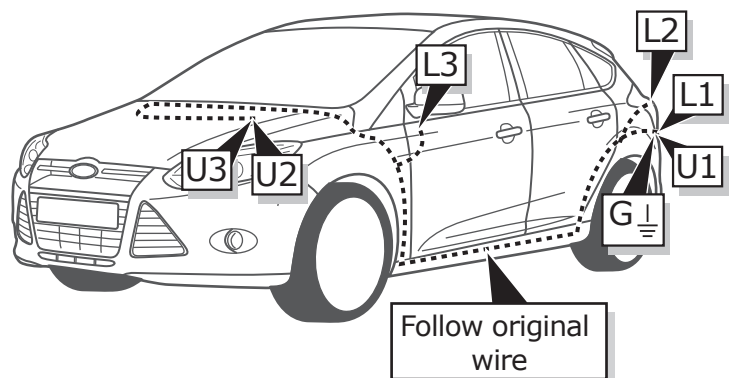

1

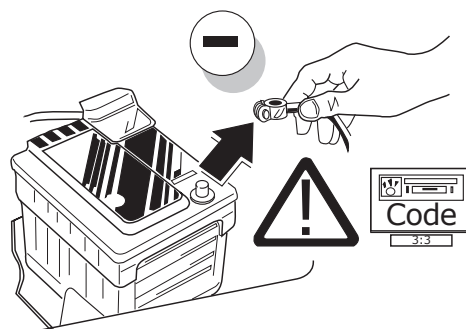

2

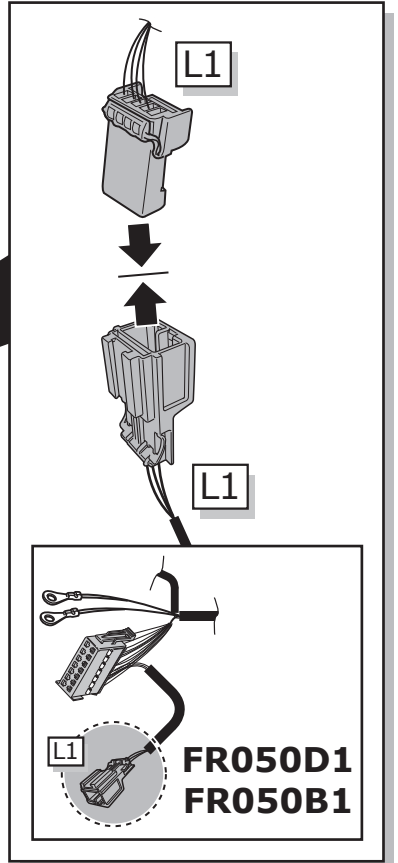
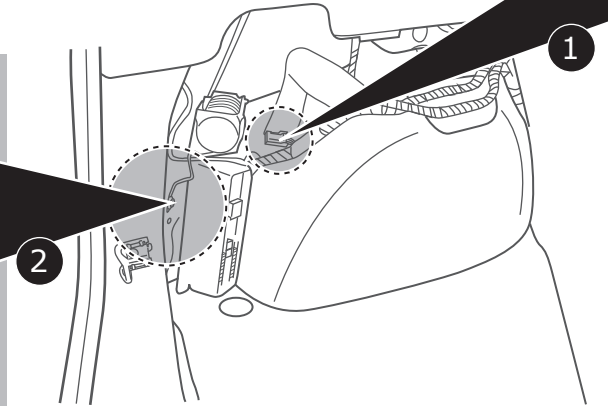
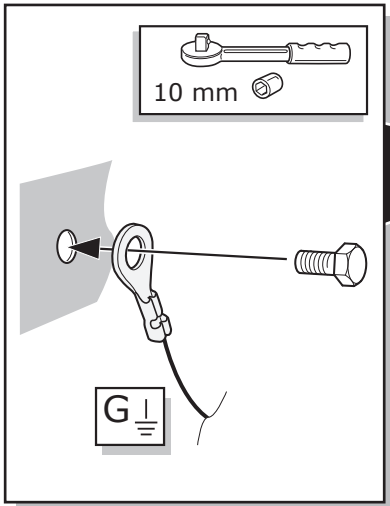
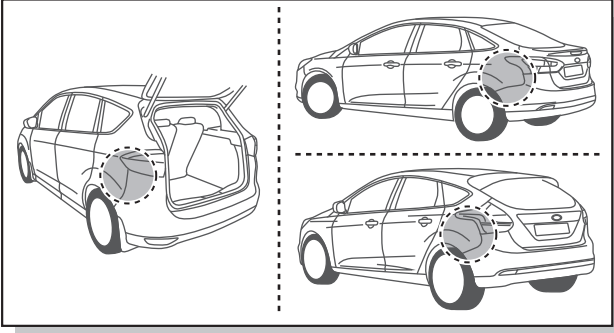

3

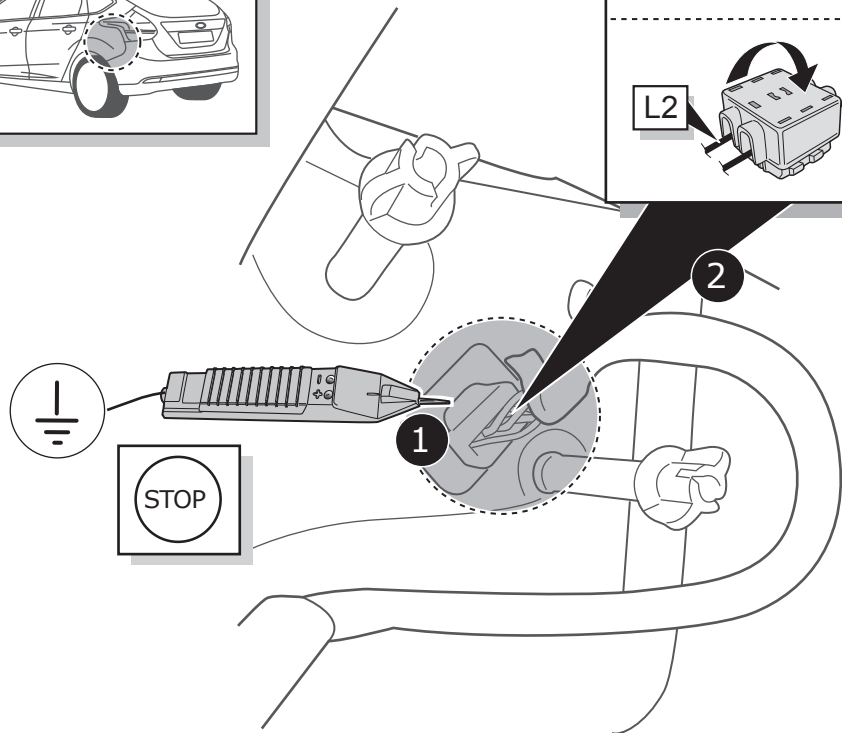
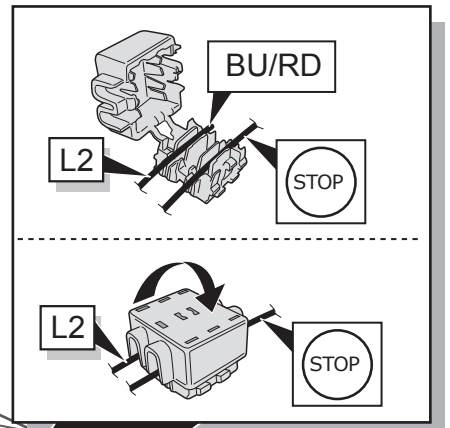
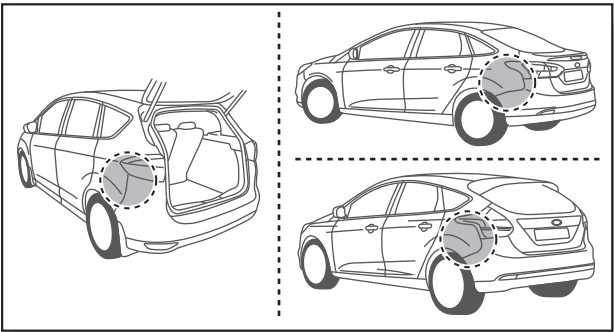

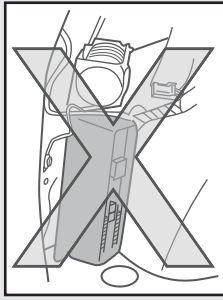

4

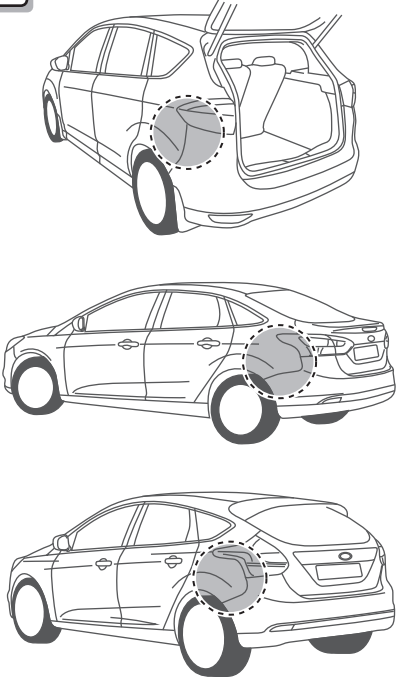

Option 1
GENUINE FORD Part

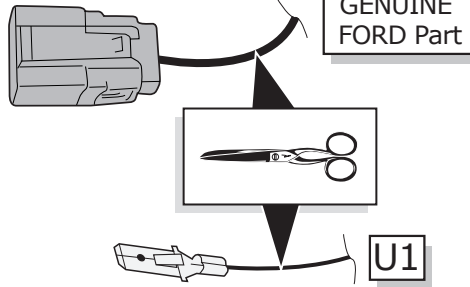

1

GENUINE FORD Part

2

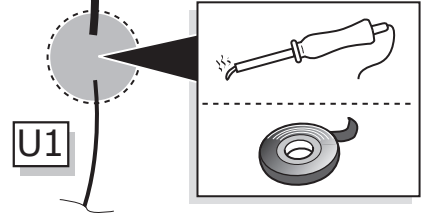

Option 2
ECS ELECTRONICS Part

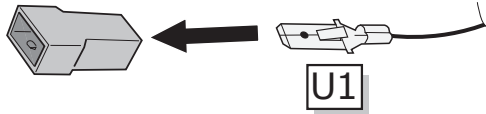

1

U1
FR050D1
FR050B1

2

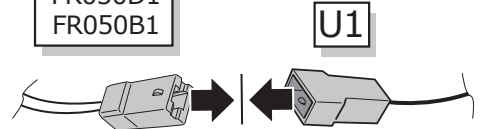

5

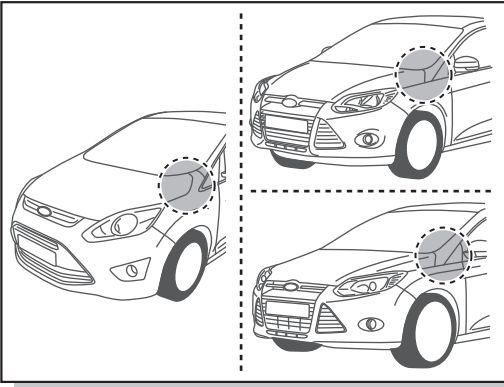

CAN H

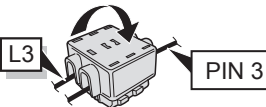
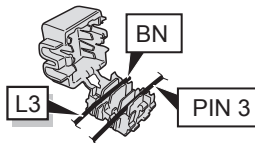

2

CAN L

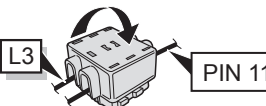
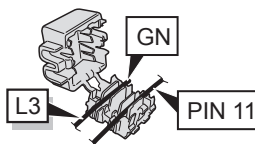

3

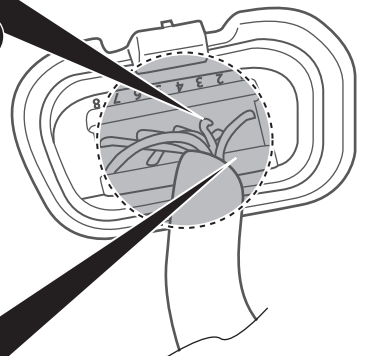
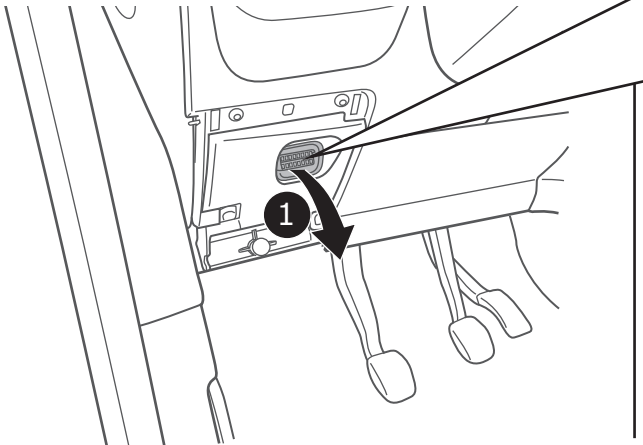

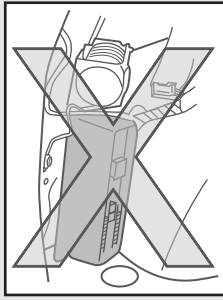

6

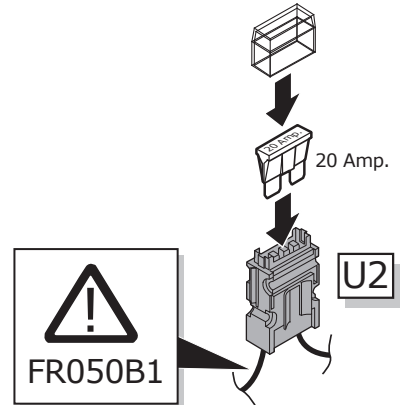
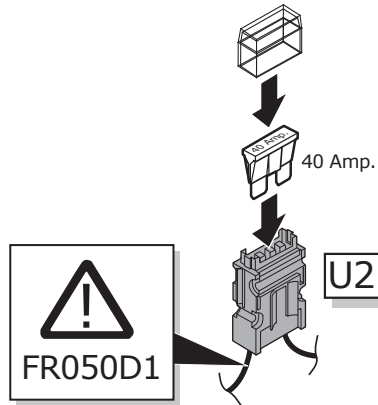
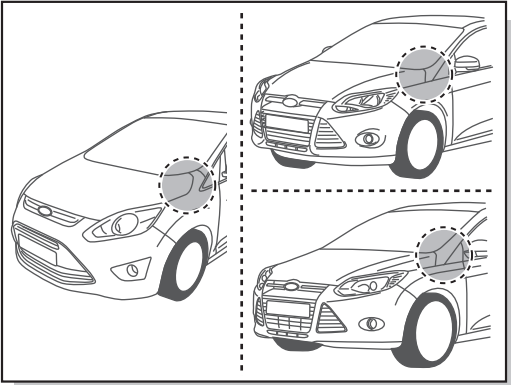

7

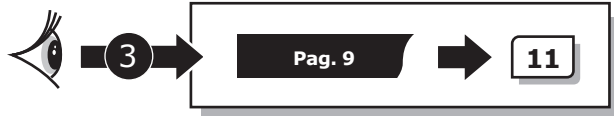
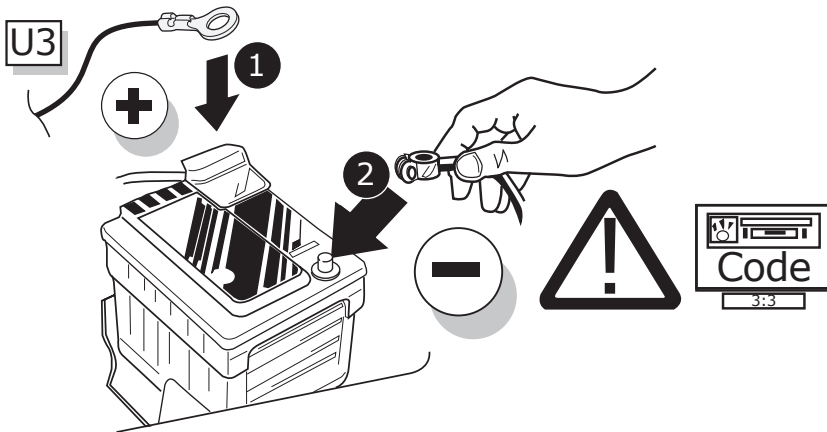

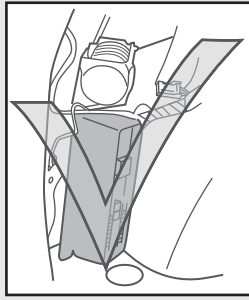

8

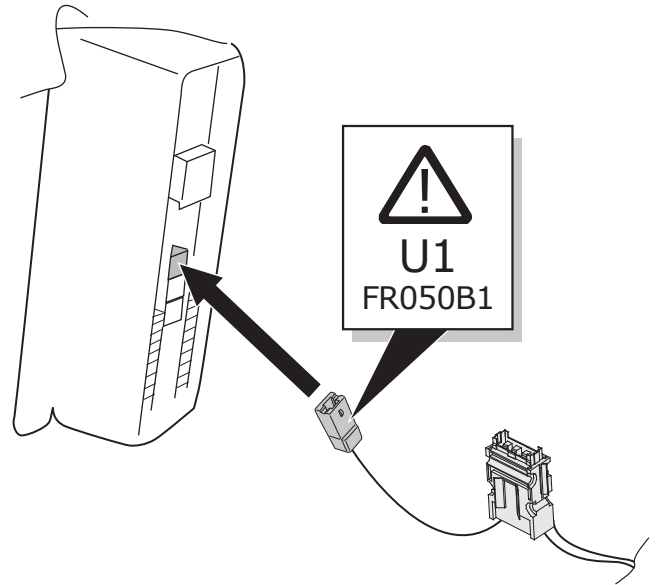
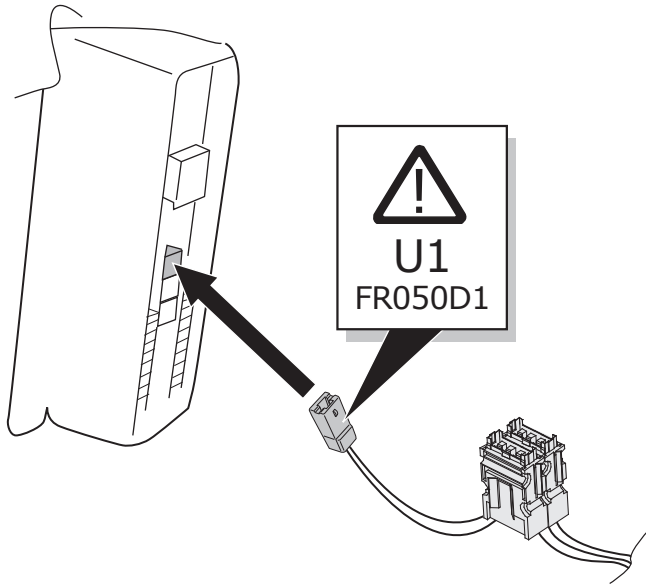

9

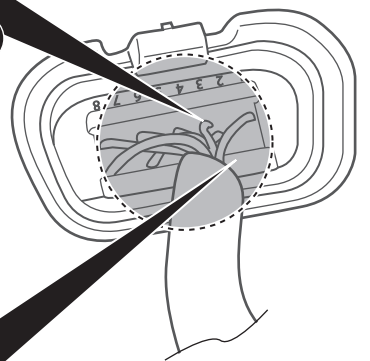
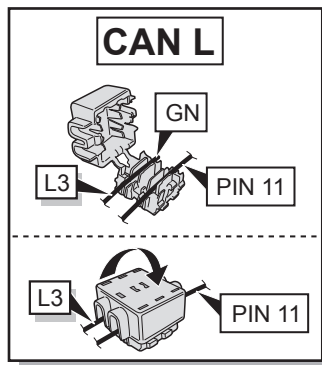
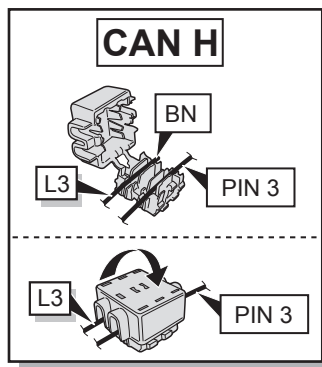
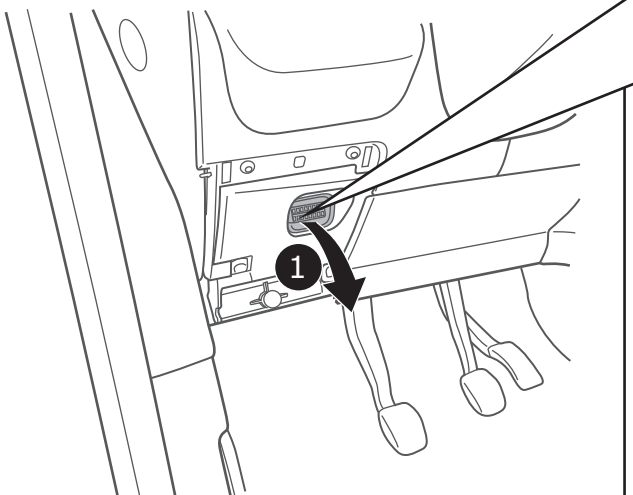
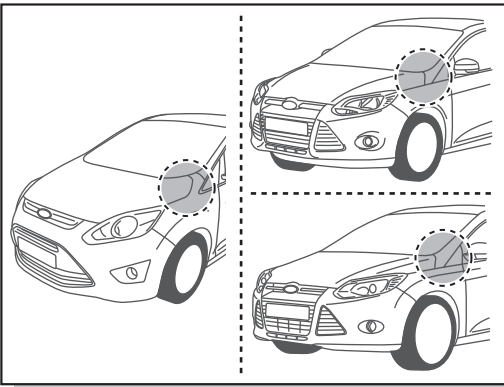

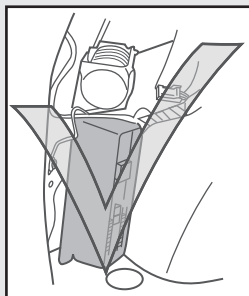

10

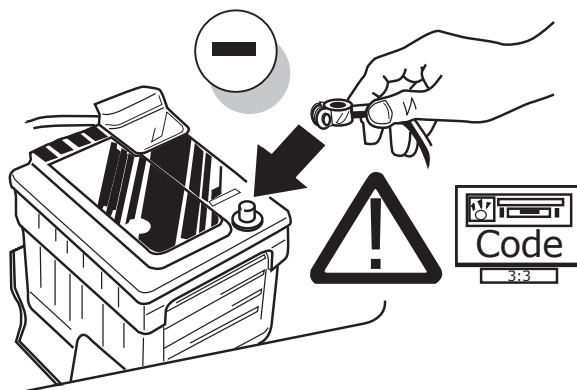

11

- (DE) FUNKTIONEN KONTROLLIEREN MIT EINEM PRÜFGERÄT MIT WIDERSTAND ODER MIT LEUCHTEN MIT DER GENAUEN WATTZAHL!
- (FR) CONTRÔLER LES FONCTIONS AVEC UNE BOÎTE DE TEST AVEC DE LA CHARGE OU DES LAMPES AVEC LA QUANTITÉ CORRECTE DE WATT!
- (NL) CONTROLEER FUNCTIES MET EEN TESTER MET BELASTING OF LAMPEN MET DE JUISTE WATTAGE!
- (GB) TEST ALL CIRCUIT FUNCTIONS WITH A TESTBOX WITH THE CORRECT POWER LOAD FOR EACH UNIT. A TESTBOX ON WHICH ONLY LEDs ARE USED CAN NOT BE USED IN THIS CASE
- (ES) ¡CONTROLAR FUNCIONES CON UN TESTER CON CARGA O LUCES CON EL CORRECTO WATTAJE!
- (IT) CONTROLLA FUNZIONI CON UN TESTER CON CARICO O LAMPADE DEL GIUSTO WATT-TAGGIO!

- (SE) KONTROLLERA FUNKTIONERNA MED EN TESTARE MED BELASTNING ELLER LAMPOR MED RÄTT WATT-VÄRDE!
- (CZ) OVĚŘTE FUNKCE POMOCÍ TESTOVACÍHO BOXU NEBO SVĚTEL S PŘÍSLUŠNÝM VÝKONEM!
- (DK) CHECK FUNKTIONERNE MED EN TESTBOKS, MED BELASTNING ELLER MED LYGTER MED DET KORREKTE ANTAL WATT!
- (FI) TARKISTA TOIMINNOT KÄYTTÄMÄLLÄ TESTILAITE, JOSSA ON OIKEATEHOINEN KUORMITUS TAI OIKEATEHOISET LAMPUT!
- (GR) ΕΛΕΓΓΕΤΕ ΤΙΣ ΛΕΙΤΟΥΡΓΙΕΣ ΜΕ ΉΝΑ ΚΙΒΩΤΙΟ ΔΟΚΙΜΗΣ ΜΕ ΦΟΡΤΙΟ Ή ΛΑΜΠΙΤΗΡΕΣ ΣΩΣΤΗΣ ΠΟΣΟΤΗΤΑΣ ΒΑΤ!
- (NO) KONTROLER FUNKSJONENE MED EN TESTER MED BELASTNING ELLER LYSPÆRER MED RIKTIG WATTVERDI!
- (PL) SPRAWDŹ FUNKCJE UŻYWAJĄC SKRZYŃKI TESTOWEJ Z OBCIĄŻENIEM LUB PODŁĄCZONYMI ŻARÓWKAMI O ODPOWIEDNIEJ MOCY!

12



00800
CALL2ECS
22 55 23 27

09.00 - 18.00
Monday - Friday
www.ecs-electronics.nl